

Digital Cinema System Specification: Compliance Test Plan

Version 1.4.1

(build c010086)

Approved for Distribution April 24, 2024
Digital Cinema Initiatives, LLC, Member Representative Committee

Important Notice

This document is a Compliance Test Plan developed by Digital Cinema Initiatives, LLC (DCI). DCI is the owner of this Compliance Test Plan for the purpose of copyright and other laws in all countries throughout the world. The DCI copyright notice must be included in all reproductions, whether in whole or in part, and may not be deleted or attributed to others. DCI hereby grants to its members and their suppliers a limited license to reproduce this Compliance Test Plan for their own use, provided it is not sold. Others must obtain permission to reproduce this Compliance Test Plan from Digital Cinema Initiatives, LLC.

This Compliance Test Plan is intended solely as a guide for companies interested in developing products that can be compatible with other products developed using this document and [DCI-DCSS]. Each DCI member company shall decide independently the extent to which it will utilize, or require adherence to, this Compliance Test Plan. DCI shall not be liable for any exemplary, incidental, proximate or consequential damages or expenses arising from the use of this document. This document defines only one approach to compatibility, and other approaches may be available to the industry. Only DCI has the right and authority to revise or change the material contained in this document, and any revisions by any party other than DCI are unauthorized and prohibited.

Using this document may require the use of one or more features covered by proprietary rights (such as features which are the subject of a patent, patent application, copyright, mask work right or trade secret right). By publication of this document, no position is taken by DCI with respect to the validity or infringement of any patent or other proprietary right. DCI hereby expressly disclaims any liability for infringement of intellectual property rights of others by virtue of the use of this document. DCI has not and does not investigate any notices or allegations of infringement prompted by publication of any DCI document, nor does DCI undertake a duty to advise users or potential users of DCI documents of such notices or allegations. DCI hereby expressly advises all users or potential users of this document to investigate and analyze any potential infringement situation, seek the advice of intellectual property counsel, and, if indicated, obtain a license under any applicable intellectual property right or take the necessary steps to avoid infringement of any intellectual property right. DCI expressly disclaims any intent to promote infringement of any intellectual property right by virtue of the evolution or publication of this document.

DCI gratefully acknowledges the participation and technical contributions of Sandflow Consulting LLC, San Mateo, CA, <https://www.sandflow.com/>, in the preparation of this document.

DCI gratefully acknowledges the participation and technical contributions of CineCert LLC, 2840 N. Lima St, Suite 110A, Burbank, CA 91504 <https://www.cinecert.com/>, in the preparation of this document.

DCI gratefully acknowledges the participation and technical contributions of the Fraunhofer Institute for Integrated Circuits, IIS, Am Wolfsmantel 33, 91058 Erlangen, Germany, <http://www.iis.fraunhofer.de/>, in the preparation of this document.

Table of Contents

CHAPTER 1.	INTRODUCTION	19
<hr/>		
1.1.	Overview	20
1.2.	Normative References	22
1.3.	Audience	22
1.4.	Conventions and Practices	22
1.4.1.	Typographical Conventions	22
1.4.2.	Documentation Format	23
1.4.3.	Terms, Definitions and Abbreviated Terms	23
1.5.	Digital Cinema System Architecture	24
1.6.	Strategies for Successful Testing	25
PART I.	PROCEDURAL TESTS	26
<hr/>		
Chapter 2.	Digital Cinema Certificates	26
2.1.	Certificate Structure	26
2.1.1.	Basic Certificate Structure	28
2.1.2.	SignatureAlgorithm Fields	28
2.1.3.	SignatureValue Field	29
2.1.4.	SerialNumber Field	29
2.1.5.	SubjectPublicKeyInfo Field	30
2.1.6.	Deleted Section	30
2.1.7.	Validity Field	30
2.1.8.	AuthorityKeyIdentifier Field	31
2.1.9.	KeyUsage Field	32
2.1.10.	Basic Constraints Field	33
2.1.11.	Public Key Thumbprint	33
2.1.12.	Organization Name Field	34
2.1.13.	OrganizationUnitName Field	35
2.1.14.	Entity Name and Roles Field	35
2.1.15.	Unrecognized Extensions	36
2.1.16.	Signature Validation	37
2.1.17.	Certificate Chains	37
2.2.	Certificate Decoder Behavior	39
2.2.1.	ASN.1 DER Encoding Check	39
2.2.2.	Missing Required Fields	39
2.2.3.	PathLen Check	40
2.2.4.	OrganizationName Match Check	41
2.2.5.	Certificate Role Check	42
2.2.6.	Validity Date Check	43

2.2.7.	Signature Algorithm Check	43
2.2.8.	Public Key Type Check	44
2.2.9.	Issuer Certificate Presence Check	44
Chapter 3.	Key Delivery Messages	45
3.1.	eXtensible Markup Language	45
3.1.1.	XML Documents	45
3.1.2.	XML Schema	46
3.1.3.	XML Signature Validation	47
3.2.	Key Delivery Message Example	49
3.3.	ETM Features	54
3.3.1.	ETM Structure	54
3.3.2.	ETM Validity Date Check	55
3.3.3.	ETM Signer Element	55
3.3.4.	ETM EncryptionMethod Element	56
3.3.5.	ETM AnnotationText Language	56
3.3.6.	ETM ReferenceList Element	56
3.3.7.	ETM SignedInfo CanonicalizationMethod Element	57
3.3.8.	ETM Signature Reference Elements	57
3.3.9.	ETM SignatureMethod Element	58
3.3.10.	ETM Signature Transforms Field	58
3.3.11.	ETM Signature DigestMethod Element	58
3.3.12.	ETM Signature Validity	59
3.4.	KDM Features	60
3.4.1.	KDM MessageType Element	60
3.4.2.	KDM SubjectName Element	60
3.4.3.	KDM ContentAuthenticator Element	61
3.4.4.	KDM Signer Certificate Presence	61
3.4.5.	KDM KeyIdList/TypedKeyId Field	62
3.4.6.	KDM ForensicMarkFlagList Element	62
3.4.7.	KDM EncryptedData Element	63
3.4.8.	KDM KeyInfo Element	63
3.4.9.	KDM DeviceListDescription Element	64
3.4.10.	KDM ContentTitleText Language Attribute	64
3.4.11.	KDM KeyType Scope Attribute	65
3.4.12.	KDM EncryptionMethod	65
3.4.13.	KDM CompositionPlaylistId Element	65
3.4.14.	KDM Validity Fields	66
3.4.15.	KDM KeyIdList Element	67
3.4.16.	KDM CipherData Structure ID	67
3.4.17.	KDM CipherData Signer Thumbprint	68
3.4.18.	KDM CipherData Validity	68
3.4.19.	KDM CipherData CPL ID	69

3.4.20.	KDM EncryptedKey KeyType	69
3.4.21.	KDM Recipient X509IssuerName	70
3.5.	KDM Decoder Behavior	70
3.5.1.	KDM NonCriticalExtensions Element	71
3.5.2.	ETM IssueDate Field Check	71
3.5.3.	Deleted Section	72
3.5.4.	Structure ID Check	72
3.5.5.	Certificate Thumbprint Check	73
3.5.6.	Deleted Section	73
3.5.7.	KeyInfo Field Check	73
3.5.8.	KDM Malformations	74
3.5.9.	KDM Signature	75
3.5.10.	KDM NonCriticalExtensions Element (OBAE)	77
3.5.11.	ETM IssueDate Field Check (OBAE)	77
3.5.12.	Structure ID Check (OBAE)	78
3.5.13.	Certificate Thumbprint Check (OBAE)	79
3.5.14.	KeyInfo Field Check (OBAE)	79
3.5.15.	KDM Malformations (OBAE)	80
3.5.16.	KDM Signature (OBAE)	81
Chapter 4.	Digital Cinema Packaging	83
4.1.	Asset Map	83
4.1.1.	Asset Map File	85
4.1.2.	Volume Index File	86
4.2.	Packing List	86
4.2.1.	Packing List File	87
4.2.2.	Packing List Signature Validation	89
4.3.	Composition Playlist	89
4.3.1.	Composition Playlist File	91
4.3.2.	Composition Playlist Signature Validation	91
4.3.3.	Composition Playlist Key Usage	92
4.4.	Track Files	92
4.4.1.	MXF Internals	93
4.4.2.	Image and Audio Packaging Standard	97
4.4.3.	Timed Text Track File Format	99
4.4.4.	Track File Length	101
4.4.5.	Image Track File Frame Boundary	101
4.4.6.	Audio Track File Frame Boundary	103
4.5.	Essence	104
4.5.1.	Image Structure Container and Image Container Format	104
4.5.2.	Image Compression Standard & Encoding Parameters	106
4.5.3.	Audio Characteristics	107
4.5.4.	Timed Text Resource Encoding	108

4.6.	Digital Cinema Package	109
4.6.1.	DCP Integrity	109
Chapter 5.	Common Security Features	110
5.1.	SPB Security Features	110
5.1.1.	SPB Digital Certificate	110
5.1.2.	Deleted Section	113
5.1.3.	Deleted Section	113
5.2.	Intra-Theater Communication	113
5.2.1.	Deleted Section	113
5.2.2.	Auditorium Security Messages	113
5.2.3.	Deleted Section	114
5.3.	Event Logs	114
5.3.1.	Log Report Format	114
5.3.2.	Event Log Operations	118
5.3.3.	SM Proxy of Log Events	126
5.4.	Security Log Events	126
5.4.1.	Playout, Validation and Key Events	126
5.4.2.	ASM and Operations Events	139
Chapter 6.	Media Block	146
6.1.	Security Manager (SM)	146
6.1.1.	Image Integrity Checking	147
6.1.2.	Sound Integrity Checking	150
6.1.3.	Deleted Section	152
6.1.4.	Restriction of Keying to MD Type	152
6.1.5.	Restriction of Keying to Valid CPLs	153
6.1.6.	Deleted Section	156
6.1.7.	Deleted Section	156
6.1.8.	Content Key Extension, End of Engagement	156
6.1.9.	ContentAuthenticator Element Check	158
6.1.10.	KDM Date Check	159
6.1.11.	KDM TDL Check	161
6.1.12.	Maximum Number of DCP Keys	163
6.1.13.	CPL Id Check	164
6.1.14.	CPL Id Check (OBAE)	165
6.1.15.	Restriction of Playback in Absence of Integrity Pack Metadata	167
6.1.16.	Restriction of Keying to MDEK Type (OBAE)	170
6.1.17.	OBAE Integrity Checking	171
6.1.18.	Content Key Extension, End of Engagement (OBAE)	173
6.1.19.	Plurality of Media Block Identity Certificates	175
6.1.20.	Validity of SPB Certificates	176
6.1.21.	Maximum Number of DCP Keys (OBAE)	177
6.1.22.	Restriction of Keying to Valid CPLs (OBAE)	179

6.1.23.	ContentAuthenticator Element Check (OBAE)	182
6.1.24.	KDM Date Check (OBAE)	183
6.2.	Link Encryption (LE)	185
6.2.1.	Deleted Section	185
6.2.2.	Deleted Section	185
6.2.3.	Deleted Section	185
6.2.4.	Deleted Section	185
6.3.	Clocks and Time	185
6.3.1.	Clock Adjustment	185
6.3.2.	SPB Type 1 Clock Battery	188
6.3.3.	Clock Resolution	189
6.3.4.	Clock Resolution (OMB)	190
6.3.5.	Clock Adjustment (OMB)	190
6.4.	Forensic Marking (FM)	192
6.4.1.	FM Application Constraints	192
6.4.2.	Granularity of FM Control	194
6.4.3.	FM Payload	197
6.4.4.	FM Audio Bypass	198
6.4.5.	Selective Audio FM Control	199
6.4.6.	FM Application Constraints (OBAE)	203
6.4.7.	Granularity of FM Control (OBAE)	204
6.4.8.	FM Payload (OBAE)	207
6.4.9.	FM Audio Bypass (OBAE)	208
6.5.	Image Reproduction	209
6.5.1.	Playback of Image Only Material	209
6.5.2.	Decoder Requirements	210
6.6.	Audio Reproduction	215
6.6.1.	Digital Audio Interfaces	216
6.6.2.	Audio Sample Rate Conversion	217
6.6.3.	Audio Delay Setup	217
6.6.4.	Click Free Splicing of Audio Track Files	220
6.7.	Timed Text Reproduction	220
6.7.1.	Media Block Overlay	220
6.7.2.	Deleted Section	222
6.7.3.	Deleted Section	222
6.7.4.	Default Timed Text Font	222
6.7.5.	Deleted Section	222
6.7.6.	Timed Text Decryption	222
6.8.	OBAE Reproduction	223
6.8.1.	Click Free Splicing of OBAE Track Files	223
6.8.2.	OBAE Delay Setup	224
6.8.3.	Maximum Bitrate OBAE	225

6.8.4.	OBAE Rendering Expectations	226
Chapter 7.	Imaging Device	227
7.1.	Test Environment for Image Measurements	227
7.1.1	General	227
7.1.2	Projector	227
7.1.3	Direct View Display	228
7.1.4	Stereoscopic Measurements	228
7.2.	SPB Type 2	228
7.2.1.	Projector and Direct View Display Physical Protection	228
7.2.2.	Projector and Direct View Display Security Servicing	230
7.2.3.	Deleted Section	232
7.2.4.	Deleted Section	232
7.2.5.	Deleted Section	232
7.2.6.	SPB2 Secure Silicon Field Replacement	232
7.2.7.	Systems without Electronic Marriage	233
7.2.8.	Electronic Marriage Break Key Retaining	233
7.3.	Companion SPB Type 1	234
7.3.1.	Deleted Section	234
7.3.2.	Companion SPBs with Electronic Marriage	234
7.3.3.	Companion SPB Marriage Break Key Retaining	236
7.3.4.	Deleted Section	238
7.4.	Link Decryptor Block	238
7.4.1.	Deleted Section	238
7.4.2.	Deleted Section	238
7.4.3.	Deleted Section	238
7.4.4.	Deleted Section	238
7.4.5.	Deleted Section	238
7.4.6.	Deleted Section	238
7.4.7.	Deleted Section	238
7.5.	Image Reproduction	238
7.5.1.	Deleted Section	238
7.5.2.	Deleted Section	238
7.5.3.	Imaging Device Pixel Count/Structure	239
7.5.4.	Deleted Section	240
7.5.5.	Deleted Section	240
7.5.6.	Deleted Section	241
7.5.7.	Deleted Section	241
7.5.8.	SDR Intra-frame Contrast	241
7.5.9.	Grayscale Tracking	242
7.5.10.	SDR Contouring	243
7.5.11.	SDR Transfer Function	244
7.5.12.	SDR Color Accuracy	245

7.5.13.	Projector Test Environment	246
7.5.14.	HDR White Luminance and Chromaticity	247
7.5.15.	SDR White Luminance and Chromaticity	248
7.5.16.	HDR Color Luminance and Chromaticity	250
7.5.17.	HDR Minimum Active Black Level	251
7.5.18.	SDR Inactive Black Level (Direct View Display)	251
7.5.19.	Horizontal and Vertical Full Screen Off-Axis Uniformity (Direct View Display)	253
7.5.20.	Stereoscopic Extinction Ratio	254
7.5.21.	SDR Stereoscopic Peak White Luminance	255
7.5.22.	Surface Reflectivity (Direct View Display)	256
7.5.23.	Vignetting (Direct View Display)	256
7.5.24.	SDR Stereoscopic Minimum Active Black Level	257
7.5.25.	Image Upscaling Artifacts	258
7.5.26.	SDR Stereoscopic Color Accuracy	260
7.5.27.	Sub-pixel Spatial Coincidence (Direct View Display)	261
7.5.28.	HDR Transfer Function	262
7.5.29.	SDR Minimum Active Black Level	263
7.5.30.	Direct View Display Test Environment	264
7.5.31.	Automatic SDR/HDR mode switching	265
7.5.32.	HDR Inactive Black Level (Direct View Display)	266
7.5.33.	Image Frame Rates	268
7.5.34.	Stereoscopic Image Frame Rates	270
7.5.35.	HDR Contouring	271
Chapter 8.	Screen Management System	272
8.1.	Ingest and Storage	272
8.1.1.	Storage System Ingest Interface	272
8.1.2.	Storage System Capacity	273
8.1.3.	Storage System Redundancy	273
8.1.4.	Storage System Performance	274
8.1.5.	Deleted Section	275
8.1.6.	Storage System Performance (OBAE)	275
8.2.	Screen Management System	276
8.2.1.	Deleted Section	276
8.2.2.	Show Playlist Creation	276
8.2.3.	Show Playlist Format	277
8.2.4.	Deleted Section	278
8.2.5.	Automation Control and Interfaces	278
8.2.6.	Interrupt Free Playback	279
8.2.7.	Artifact Free Transition of Image Format	280
8.2.8.	Restarting Playback	280
8.2.9.	SMS User Accounts	281
8.2.10.	SMS Operator Identification	282

8.2.11.	SMS Identity and Certificate	283
8.2.12.	Content Keys and TDL check	284
8.2.13.	Content Keys and TDL check (OBAE)	285
8.2.14.	KDM Content Keys Check	286
8.2.15.	Validity of SMS Certificates	288
8.2.16.	Interrupt Free Playback (OBAE)	289
8.2.17.	Restarting Playback (OBAE)	290
8.2.18.	Show Playlist Creation (OBAE)	291
8.2.19.	Deleted Section	292
8.2.20.	SMS Operator Identification (OBAE)	292
PART II.	DESIGN EVALUATION GUIDELINES	293
Chapter 9.	FIPS Requirements for a Type 1 SPB	293
9.1.	FIPS Testing Procedures	294
9.2.	Submitted Materials	295
9.3.	CMVP Testing Laboratory Reports	296
9.4.	Interpreting FIPS Test Reports	296
9.5.	DCI Requirements for FIPS Modules	297
9.5.1.	SM Operating Environment	297
9.5.2.	Deleted Section	297
9.5.3.	SPB Type 1 Tamper Responsiveness	297
9.5.4.	Deleted Section	298
9.5.5.	Deleted Section	298
9.5.6.	SPB Type 1 FIPS Requirements	298
9.5.7.	Deleted Section	298
9.5.8.	Asymmetric Key Generation	298
9.5.9.	Critical Security Parameter Protection	298
9.5.10.	Deleted Section	299
9.5.11.	Degraded mode(s) of operation prohibited	299
9.5.12.	Control output inhibition	299
9.5.13.	Maintenance role/interface prohibited	300
9.5.14.	Self-initiated cryptographic output capability	300
9.5.15.	Self-initiated cryptographic output capability	300
9.5.16.	Periodic self-tests	301
Chapter 10.	DCI Requirements Review	301
10.1.	Type 1 SPB Documentation	301
10.2.	Type 2 SPB Documentation	302
10.3.	Forensic Mark IP Disclosure	303
10.4.	DCI Requirements for Security Modules	303
10.4.1.	Theater System Reliability	303
10.4.2.	Theater System Storage Security	303
10.4.3.	Deleted Section	304

10.4.4.	Security Entity Physical Protection	304
10.4.5.	Secure SMS-SM Communication	304
10.4.6.	Location of Security Manager	304
10.4.7.	Deleted Section	305
10.4.8.	Deleted Section	305
10.4.9.	Deleted Section	305
10.4.10.	Deleted Section	305
10.4.11.	Deleted Section	305
10.4.12.	Deleted Section	305
10.4.13.	TLS Session Key Refreshes	305
10.4.14.	LE Key Issuance	305
10.4.15.	Maximum Key Validity Period	305
10.4.16.	KDM Purge upon Expiry	306
10.4.17.	Deleted Section	306
10.4.18.	Imaging Device Secure Silicon Device	306
10.4.19.	Access to Imaging Device Image Signals	306
10.4.20.	Systems with Electronic Marriage	306
10.4.21.	Systems Without Electronic Marriage	307
10.4.22.	Clock Date-Time-Range	307
10.4.23.	Clock Setup	307
10.4.24.	Clock Stability	308
10.4.25.	Repair and Renewal of SPBs	308
10.4.26.	SPB2 Protected Devices	308
10.4.27.	Clock Continuity	309
10.4.28.	Deleted Section	309
10.4.29.	Deleted Section	309
10.4.30.	Deleted Section	309
10.4.31.	Deleted Section	309
10.4.32.	Deleted Section	309
10.4.33.	Deleted Section	309
10.4.34.	Deleted Section	309
10.4.35.	Deleted Section	309
10.4.36.	Deleted Section	310
10.4.37.	Deleted Section	310
10.4.38.	Deleted Section	310
10.4.39.	Deleted Section	310
10.4.40.	Deleted Section	310
10.4.41.	Deleted Section	310
10.4.42.	FM Algorithm General Requirements	310
10.4.43.	FM Insertion Requirements	310
10.4.44.	IFM Visual Transparency	311
10.4.45.	IFM Robustness	311

10.4.46.	AFM Inaudibility	311
10.4.47.	AFM Robustness	312
10.4.48.	FM Control Instance	312
10.4.49.	Deleted Section	312
10.4.50.	Deleted Section	312
10.4.51.	SPB Log Storage Requirements	312
10.4.52.	Deleted Section	313
10.4.53.	MB Log Storage Capabilities	313
10.4.54.	Deleted Section	313
10.4.55.	Deleted Section	313
10.4.56.	SPB Log Failure	313
10.4.57.	Log Purging in Failed SPBs	313
10.4.58.	MB Tasks	314
10.4.59.	Type 1 SPB RSA Private Keys	314
10.4.60.	Content Keys Outside Secure Silicon	315
10.4.61.	Prohibition of SPB Type 1 Field Serviceability	315
10.4.62.	Use of Software Protection Methods	315
10.4.63.	TMS Role	315
10.4.64.	D-Cinema Security Parameter Protection	316
10.4.65.	RSA Key Entropy	316
10.4.66.	Preloaded Symmetric Key Entropy	316
10.4.67.	Media Block Caching of Keys	316
10.4.68.	SPB Type 1 Firmware Modifications	317
10.4.69.	SPB Type 1 Log Retention	317
10.4.70.	Deleted Section	317
10.4.71.	Deleted Section	317
10.4.72.	SPB Secure Silicon Requirements	318
10.4.73.	SPB Type 1 Battery Life	318
10.4.74.	Companion SPB Retrieve Imaging Device Cert	318
10.4.75.	Log Collection for Married MB	318
10.4.76.	Companion SPB Single Purpose Requirement	319
10.4.77.	Deleted Section	319
10.4.78.	Imaging Device SPB Log Reporting Requirements	319
10.4.79.	TLS RSA Requirement	319
10.4.80.	TLS Authentication of Dual Certificate SM	319
10.4.81.	Constrained OMB Processing Capability	320
10.4.82.	Export of KDM-Borne Keys	320
10.4.83.	Deleted Section	320
10.4.84.	Deleted Section	320
10.4.85.	OBAE FM Robustness	320
10.4.86.	OBAE FM Inaudibility	321
10.5.	DCI Requirements for Imaging Devices	321

10.5.1.	Pixel Visibility (Direct View Display)	321
PART III.	CONSOLIDATED TEST PROCEDURES	322
Chapter 11.	Testing Policy and Reporting	322
11.1.	Test Reports	322
11.2.	Testing Policy	324
11.2.1.	Definitions	324
11.2.2.	Combining Devices into Families	324
11.2.3.	Equipment Component Failures during Testing	325
11.2.4.	Changes to Previously DCI CTP Compliant Devices	326
Chapter 12.	Deleted Chapter	327
Chapter 13.	Deleted Chapter	327
Chapter 14.	Deleted Chapter	327
Chapter 15.	Integrated IMB Consolidated Test Sequence	327
15.1.	Overview	327
15.2.	Integrated IMB Test Sequence	327
15.3.	Integrated IMB Design Review	329
15.4.	Integrated IMB Confidence Sequence	331
Chapter 16.	Deleted Chapter	332
Chapter 17.	Deleted Chapter	332
Chapter 18.	Deleted Chapter	332
Chapter 19.	Deleted Chapter	332
Chapter 20.	OMB Consolidated Test Sequence	332
20.1.	Overview	332
20.2.	OMB Test Sequence	332
20.3.	OMB Design Review	334
20.4.	OMB Confidence Sequence	335
Chapter 21.	Integrated IMBO Consolidated Test Sequence	336
21.1.	Overview	336
21.2.	Integrated IMBO Test Sequence	336
21.3.	Integrated IMBO Design Review	339
21.4.	Integrated IMBO Confidence Sequence	341
Chapter 22.	Deleted Chapter	341
Chapter 23.	Deleted Chapter	341
Chapter 24.	SDR Projector Consolidated Test Sequence	341
24.1.	Overview	341
24.2.	SDR Projector Test Sequence	342
24.3.	SDR Projector Design Review	342
24.4.	SDR Projector Confidence Sequence	343
Chapter 25.	Deleted Chapter	343
Chapter 26.	HDR Direct View Display Consolidated Test Sequence	343
26.1.	Overview	343

26.2.	HDR Direct View Display Test Sequence	344
26.3.	HDR Direct View Display Design Review	345
26.4.	HDR Direct View Display Confidence Sequence	345
Chapter 27.	SDR Direct View Display Consolidated Test Sequence	346
27.1.	Overview	346
27.2.	SDR Direct View Display Test Sequence	346
27.3.	SDR Direct View Display Design Review	347
27.4.	SDR Direct View Display Confidence Sequence	348
Chapter 28.	HDR Projector Consolidated Test Sequence	348
28.1.	Overview	348
28.2.	HDR Projector Test Sequence	348
28.3.	HDR Projector Design Review	349
28.4.	HDR Projector Confidence Sequence	350
APPENDIX A. TEST MATERIALS		350
<hr/>		
A.1.	Overview	350
A.2.	Images	350
A.3.	Sound	440
A.4.	D-Cinema Packages	466
A.5.	Digital Certificates	517
A.6.	Key Delivery Messages	536
APPENDIX B. EQUIPMENT LIST		576
<hr/>		
B.1.	Hardware	576
B.2.	Software	577
APPENDIX C. SOURCE CODE		578
<hr/>		
C.1.	Overview	578
C.2.	dc-thumbprint	579
C.3.	schema-check	581
C.4.	kdm-decrypt	583
C.5.	j2c-scan	585
C.6.	Deleted Section	587
C.7.	uuid_check.py	587
C.8.	dsig_cert.py	588
C.9.	dsig_extract.py	591
APPENDIX D. DELETED SECTION		592
<hr/>		
APPENDIX E. GPIO TEST FIXTURE		592
<hr/>		
APPENDIX F. REFERENCE DOCUMENTS		593
<hr/>		
APPENDIX G. DIGITAL CINEMA SYSTEM SPECIFICATION REFERENCES TO CTP		598
<hr/>		

APPENDIX H.	ABBREVIATIONS	609
<hr/>		
APPENDIX I.	SUBTITLE TEST EVALUATION AND PASS/FAIL CRITERIA	611
<hr/>		
I.1.	Overview	611
I.2.	Basic Pass/Fail Criteria	612
I.3.	Specific Pass/Fail Criteria	612
APPENDIX J.	OBAAE TEST EVALUATION REQUIREMENTS	621
<hr/>		
J.1.	Overview	621
J.2.	Configuration	621
J.3.	Requirements	621
J.4.	Expectations	622
APPENDIX K.	SUMMARY OF SUBSTANTIVE CHANGES	634
<hr/>		
K.1.	Overview	634
K.2.	Changes prior to CTP 1.2.1	634
K.3.	Changes between CTP 1.2.1 and CTP 1.3	634
K.4.	Changes between CTP 1.3 and CTP 1.3.1	636
K.5.	Changes between CTP 1.3.1 and CTP 1.3.2	636
K.6.	Changes between CTP 1.3.2 and CTP 1.3.3	636
K.7.	Changes between CTP 1.3.3 and CTP 1.4b	637
K.8.	Changes between CTP 1.4b and this version	637

Table of Figures

Figure 1.1.	Typical DCI Compliant System Configuration	25
Figure 6.1.	Standard Frame Panel Designations	215
Figure 6.2.	Audio Delay Timing	219
Figure 7.1.	Pixel Structure 16 x 16 Array	239
Figure 7.2.	Pixel Structure 8 x 8 Array	240
Figure 7.25(a).	Sample aliasing artifacts	259
Figure 7.25(b).	Sample ringing artifacts	259
Figure 7.25(c).	Sample spatial discontinuities (jaggies)	259
Figure 7.5.27	Illustration of a fringing artifact (not to scale)	261
Figure 7.5.33.	Location of the elements displayed when testing image frame rates (not to scale)	269
Figure 7.5.34.	Location of the elements displayed when testing stereoscopic image frame rates (not to scale)	271
Figure A.2.2.	Sync Count	351
Figure A.2.8.	"NIST" 2K Test Pattern	354
Figure A.2.10.	Black to Gray Step Series	355
Figure A.2.11.	Black to White Step Series	356
Figure A.2.12.	Color Accuracy Series	357
Figure A.2.16.	Intra-Frame Contrast Sequence	359
Figure A.2.20.	DCI Numbered Frame Sequence	361
Figure A.2.39.	FM Constraints Begin (Encrypted)	368
Figure A.2.53.	DCI_gradient_step_s_white_j2c_pt	372
Figure A.2.222.	Sync Count with Subtitle Reticles	423
Figure A.2.239.	Black frame with registration marks (not to scale)	427
Figure A.2.245.	Frame with an active area (not to scale)	429
Figure A.2.253.	Frame with horizontal, vertical and oblique white lines on a black background (not to scale)	431
Figure A.2.254.	Frame with line segments, uniform gray square and zone plate	432
Figure E.1.	GPIO Test Fixture Schematic	592
Figure E.2.	GPIO Test Fixture Connector	593
Figure J.1.	Visual contents of the OBAE Rendering Expectations test material	621

Table of Examples

Example 2.1.	D-Cinema Certificate	27
Example 3.1.	Packing List Example (Partial)	46
Example 3.2.	checksig execution	47
Example 3.3.	dsig_cert.py execution	47
Example 3.4.	An X.509 certificate in PEM format	48
Example 3.5.	dsig_extract.py execution	49
Example 3.6.	KDM - AuthenticatedPublic area	50
Example 3.7.	KDM - AuthenticatedPrivate area	52
Example 3.8.	KDM - Signature area	53
Example 3.9.	kdm-decrypt Usage and Output	54
Example 4.1.	Asset Map	84
Example 4.2.	Volume Index	85
Example 4.3.	Packing List	87
Example 4.4.	Composition Playlist	90
Example 4.5.	MXF Partition Header	93
Example 4.6.	Source Package structure	94
Example 4.7.	Cryptographic Framework and Cryptographic Context	95
Example 4.8.	Essence Descriptor for JPEG 2000	96
Example 4.9.	Essence Descriptor for PCM Audio	97
Example 4.10.	MXF Random Index Pack (RIP)	97
Example 5.1.	Log Report Example	115
Example 5.2.	Log Report Record Example	116
Example 5.3.	Log Report Signature Example	117
Example C.1.	dc-thumbprint execution	579
Example C.2.	Using schema-check to check well-formedness	581
Example C.3.	Using schema-check to check validity	581
Example C.4.	kdm-decrypt execution	583
Example C.5.	j2c-scan execution	585
Example C.7.	uuid_check.py execution	587
Example C.8.	dsig_cert.py execution	589
Example C.9.	dsig_extract.py execution	591

Table of Tables

Table 4.1.	Essence Container UL Values for D-Cinema	94
Table 4.2.	Audio Samples Per Frame	103
Table 4.3.	Image Structure Operational Levels	105
Table 5.1.	Media Block Leaf Certificate Criteria	111
Table 6.1.	List of Compositions with missing integrity pack items	167
Table 7.5.11(a)	Black-to-white gray step-scale test pattern nominal luminance values	244
Table 7.5.11(b)	Black-to-dark gray step-scale test pattern nominal luminance values	245
Table 7.5.14(a)	HDR White (Peak)	248
Table 7.5.14(b)	HDR White (Angular Nonuniformity)	248
Table 7.5.15(a)	SDR White (Peak)	249
Table 7.5.15(b)	SDR White (Angular Nonuniformity)	249
Table 7.5.16	Target HDR color luminances and chromaticities	250
Table 7.1.	Measurement positions and tolerances for horizontal and vertical full screen off-axis performance measurements	254
Table 7.5.28(a)	HDR black-to-white gray step-scale test pattern nominal luminance values	262
Table 7.5.28(b)	HDR black-to-dark gray step-scale test pattern nominal luminance values	263
Table 7.5.31	Target SDR and HDR luminances	266
Table 8.2.14.	List of Compositions and associated KDMs with mismatched content keys	287
Table 11.1.	Test Session Data	323
Table 11.2.	Test Sequences	323
Table 11.3.	General family group information	325
Table A.2.292	Dark Gray Scale X'Y'Z' 12-bit Codevalues	439
Table A.2.293	Dark Gray Scale X"Y"Z" 12-bit Codevalues	440
Table J.4.1.	Sync Test	622
Table J.4.2.	Simple Bed Channel Routing (5.1)	622
Table J.4.3.	Simple Bed Channel Routing (7.1DS)	622
Table J.4.4.	Simple Bed Channel Routing (9.1OH)	623
Table J.4.5.	'91OH' Bed - Gain Test	624
Table J.4.6.	'91OH' Bed - Decorrelation Test	624
Table J.4.7.	Pink Noise 13.1HT Bed with 3 Spoken Conditional Beds	624
Table J.4.8.	Bed Remap Test (Source: 13.1HT Bed, Dest: 5.1, 7.1DS, 11.1HT, 9.1OH)	624
Table J.4.9.	Mixing of Two Simultaneous Beds	625
Table J.4.10.	Object Gain Test	627
Table J.4.11.	Object Snap Test	627
Table J.4.12.	Object Zone Gain Test (using ZERO/ONE gain flags)	627
Table J.4.13.	Object Zone Gain Test (using decimal gain)	628
Table J.4.14.	Object Spread Test	629
Table J.4.15.	Object - Decorrelation Test	629

Table J.4.16.	Multiple Objects (3) combined with Snap/Spread Test	630
Table J.4.17.	Pan Sub-Block Test #2	631
Table J.4.18.	10 Simultaneous Objects, No Bed	631
Table J.4.19.	15 Simultaneous Objects, No Bed	631
Table J.4.20.	18 Simultaneous Objects, No Bed	631
Table J.4.21.	30 Simultaneous Objects, No Bed	631
Table J.4.22.	50 Simultaneous Objects, No Bed	631
Table J.4.23.	128 Simultaneous Objects, No Bed	631
Table J.4.24.	10 Simultaneous Objects, Quiet 9.1OH Bed	631
Table J.4.25.	15 Simultaneous Objects, Quiet 9.1OH Bed	632
Table J.4.26.	18 Simultaneous Objects, Quiet 9.1OH Bed	632
Table J.4.27.	30 Simultaneous Objects, Quiet 9.1OH Bed	632
Table J.4.28.	50 Simultaneous Objects, Quiet 9.1OH Bed	632
Table J.4.29.	118 Simultaneous Objects, Quiet 9.1OH Bed	632
Table J.4.30.	Authoring Tool Info Test	632
Table J.4.31.	Authoring Tool Info Test	632
Table J.4.32.	Unknown Element Test	633
Table J.4.33.	Unknown Element Test	633
Table J.4.34.	User Data Test	633
Table J.4.35.	User Data Test	633
Table J.4.36.	Audio Description Test	633
Table K.1.	CTP releases	634

CHAPTER 1. INTRODUCTION

Digital Cinema Initiatives, LLC (DCI) is a joint venture of Disney, Fox, Paramount, Sony Pictures Entertainment, Universal, and Warner Bros. Studios. The primary purpose of DCI is to establish uniform specifications for d-cinema. These DCI member companies believe that d-cinema will provide real benefits to theater audiences, theater owners, filmmakers and distributors. DCI was created with the recognition that these benefits could not be fully realized without industry-wide specifications. All parties involved in d-cinema must be confident that their products and services are interoperable and compatible with the products and services of all industry participants. The DCI member companies further believe that d-cinema exhibition will significantly improve the movie-going experience for the public.

Digital cinema is today being used worldwide to show feature motion pictures to thousands of audiences daily, at a level of quality commensurate with (or better than) that of 35mm film release prints. Many of these systems are informed by the *Digital Cinema System Specification, Version 1.0*, published by DCI in 2005. In areas of image and sound encoding, transport security and network services, today's systems offer practical interoperability and an excellent movie-going experience. These systems were designed, however, using de-facto industry practices.

With the publication of the *Digital Cinema System Specification* [DCI-DCSS], and the publication of required standards from SMPTE, ISO, and other bodies, it is possible to design and build d-cinema equipment that meets all DCI requirements. Manufacturers preparing new designs, and theaters planning expensive upgrades are both grappling with the same question: how to know if a d-cinema system is *compliant* with DCI requirements?

Note: This test plan references standards from SMPTE, ISO, and other bodies that have specific publication dates. The specific version of the referenced document to be used in conjunction with this test plan shall be those listed in Appendix F.

1.1. Overview

This Compliance Test Plan (CTP) was developed by DCI to provide uniform testing procedures for d-cinema equipment. The CTP details testing procedures, reference files, design evaluation methods, and directed test sequences for content packages and specific types of equipment. These instructions will guide the Test Operator through the testing process and the creation of a standard DCI compliance evaluation report.

This document is presented in three parts and eight appendices.

- Part I. Procedural Tests — contains a library of test procedures for elements of a d-cinema system. Many of the test procedures are applicable to more than one element. The procedure library will be used in Part III. Consolidated Test Procedures to produce complete sequences for testing content and specific types of systems.
 - Chapter 2. Digital Cinema Certificates — describes test objectives and procedures to test d-cinema certificates and devices which use d-cinema certificates for security operations.
 - Chapter 3. Key Delivery Messages — describes test objectives and procedures to test Key Delivery Messages (KDM) and devices which decrypt KDM payloads.
 - Chapter 4. Digital Cinema Packaging — describes test objectives and procedures to test the files in a Digital Cinema Package (DCP).
 - Chapter 5. Common Security Features — describes test objectives and procedures to test security requirements that apply to more than one type of d-cinema device (*e.g.*, an SMS or a projector). Security event logging is also addressed in this chapter.
 - Chapter 6. Media Block — describes test objectives and procedures to test that Media Block device operations are correct and valid.
 - Chapter 7. Imaging Device — describes test objectives and procedures to test that imaging device operations are correct and valid.
 - Chapter 8. Screen Management System — describes test objectives and procedures to test that Screen Management System (SMS) operations are correct and valid.
- Part II. Design Evaluation Guidelines — contains two chapters that describe DCI security requirements for the design and implementation of d-cinema equipment, and methods for verifying those requirements through document analysis. Requirements in this part of the CTP cannot easily be tested by normal system operation. FIPS 140 requirements for deriving random numbers, for example, must be verified by examining the documentation that is the basis of the FIPS certification.

- Chapter 9. FIPS Requirements for a Type 1 SPB — provides a methodology for evaluating the results of a FIPS 140 security test. Material submitted for testing and the resulting reports are examined for compliance with [DCI-DCSS] requirements.
 - Chapter 10. DCI Requirements Review — provides a methodology for evaluating system documentation to determine whether system aspects that cannot be tested by direct procedural method are compliant with [DCI-DCSS] requirements.
- Part III. Consolidated Test Procedures — contains consolidated test sequences for testing d-cinema equipment and content.
 - Chapter 11. Testing Policy and Reporting — Provides an overview of the consolidated testing and test reports and a standard form for reporting details of the testing environment.
 - Chapter 15. Integrated IMB Consolidated Test Sequence
 - Chapter 20. OMB Consolidated Test Sequence
 - Chapter 21. Integrated IMBO Consolidated Test Sequence
 - Chapter 24. SDR Projector Consolidated Test Sequence
 - Chapter 26. HDR Direct View Display Consolidated Test Sequence
 - Chapter 27. SDR Direct View Display Consolidated Test Sequence
 - Chapter 28. HDR Projector Consolidated Test Sequence
- Appendix A. Test Materials — Provides a complete description of all reference files used in the test procedures including Digital Cinema Packages, KDMs and Certificates.
- Appendix B. Equipment List— Provides a list of test equipment and software used to perform the test procedures. The list is not exclusive and in fact contains many generic entries intended to allow Testing Organizations to exercise some discretion in selecting their tools.
- Appendix C. Source Code — Provides computer programs in source code form. These programs are included here because suitable alternatives were not available at the time this document was prepared.

- [Appendix E. GPIO Test Fixture](#) — Provides a schematic for a GPIO test fixture.
- [Appendix F. Reference Documents](#) — Provides a complete list of the documents referenced by the test procedures and design requirements.
- [Appendix G. Digital Cinema System Specification References to CTP](#) — Provides a cross reference of [DCI-DCSS] sections to the respective CTP sections.
- [Appendix H. Abbreviations](#) — Provides explanations of the abbreviations used in this document.
- [Appendix K. Summary of substantive changes](#) — Summarizes changes across versions of this document.

1.2. Normative References

The procedures in this document are substantially traceable to the many normative references cited throughout. In some cases, DCI have chosen to express a constraint or required behavior directly in this document. In these cases it will not be possible to trace the requirement directly to an external document. Nonetheless, the requirement is made normative for the purpose of DCI compliance testing by its appearance in this document.

1.3. Audience

This document is written to inform readers from many segments of the motion picture industry, including manufacturers, content producers, distributors, and exhibitors. Readers will have specific needs of this text and the following descriptions will help identify the parts that will be most useful to them. Generally though, the reader should have technical experience with d-cinema systems and access to the required specifications. Some experience with general operating system concepts and installation of source code software will be required to run many of the procedures.

Equipment Manufacturers

To successfully pass a compliance test, manufacturers must be aware of all requirements and test procedures. In addition to understanding the relevant test sequence and being prepared to provide the Test Operator with information required to complete the tests in the sequence, the manufacturer is also responsible for preparing the documentation called for in [Part II. Design Evaluation Guidelines](#).

Testing Organizations and Test Operators

The Testing Organizations and Test Operators are responsible for assembling a complete testing environment with all required tools and for guiding the manufacturer through the process of compliance testing. Like the manufacturer, Testing Organizations and Test Operators must be aware of all requirements and test procedures at a very high level of detail.

System Integrators

Integrators will need to understand the reports issued by Testing Organizations. Comparing systems using reported results will be more accurate if the analyst understands the manner in which individual measurements are made.

1.4. Conventions and Practices

1.4.1. Typographical Conventions

This document uses the following typographical conventions to convey information in its proper context.

A **Bold Face** style is used to display the names of commands to be run on a computer system.

A Fixed Width font is used to express literal data such as string values or element names for XML documents, or command-line arguments and output.

Examples that illustrate command input and output are displayed in a Fixed Width font on a shaded background:

```
$ echo "Hello, World!"  
Hello, World! 1
```

Less-than (<) and greater-than (>) symbols are used to illustrate generalized input values in command-line examples. They are placed around the generalized input value, *e.g.*, <input-value>. These symbols are also used to direct command output in some command-line examples, and are also an integral part of the XML file format.

Callouts (white numerals on a black background, as in the example above) are used to provide reference points for examples that include explanations. Examples with callouts are followed by a list of descriptions explaining each callout.

Square brackets ([and]) are used to denote an external document reference, *e.g.*, [SMPTE-377-1].

1.4.2. Documentation Format

The test procedures documented in [Part I. Procedural Tests](#) will contain the following sub-sections (except as noted)

Objective —

Describes what requirements or assertions are to be proven by the test.

Procedures —

Defines the steps to be taken to prove the requirements or assertions given in the corresponding objective.

Material —

Describes the material (reference files) needed to execute the test. This section may not be present, for example, when the objective can be achieved without reference files.

Equipment —

Describes what physical equipment and/or computer programs are needed for executing the test. The equipment list in each procedure is assumed to contain the Test Subject. If the equipment list contains one or more computer programs, the list is also assumed to contain a general purpose computer with a POSIX-like operating system (*e.g.*, Linux). This section may not be present, for example, when the objective can be achieved by observation alone.

References —

The set of normative documents that define the requirements or assertions given in the corresponding objective.

1.4.3. Terms, Definitions and Abbreviated Terms

Media Block and Controlling Devices

This term refers to the combination of a Media Block (MB), Screen Management System (SMS) or Theater Management System (TMS), content storage and all cabling necessary to interconnect these devices. Depending upon actual system configuration, all of these components may exist in a single chassis or may exist in separate chassis. Some or all components may be integrated into the imaging device (see below).

High-Dynamic Range (HDR)

Refers to image content that conforms to the HDR-DCDM characteristics specified at [DCI-HDR].

Standard Dynamic Range (SDR)

Refers to image content that conforms to the Image DCDM characteristics specified at [SMPTE-428-1].

Imaging Device

The imaging device is the device responsible for converting the electrical signals from the Media Block to a human visible picture. This includes all necessary power supplies and cabling. This includes both Projectors and Direct View Displays.

Testing Organization

An organization which offers testing services based on this document.

Test Operator

A member of the Testing Organization that performs testing services.

Test Subject

A device or computer file which is the subject of a test based on this document.

Theater System

A complete exhibition system to perform playback of d-cinema content, including all cabling, power supplies, content storage devices, controlling terminals, media blocks, imaging devices and sound processing devices necessary for a faithful presentation of the content, plus all the surrounding devices needed for full theater operations including theater loudspeakers and electronics (the "B-Chain"), theater automation, a theater network, and management workstations (depending upon implementation), etc.

Note: Note – There may be additional restrictions, depending on implementation. For example, some Media Blocks may refuse to perform even the most basic operations as long as they are not attached to an SMS or Imaging Device. For these environments, additional equipment may be required.

1.5. Digital Cinema System Architecture

The [DCI-DCSS] allows different system configurations, meaning different ways of grouping functional modules and equipment together. The following diagram shows what is considered to be a typical configuration allowed by DCI.

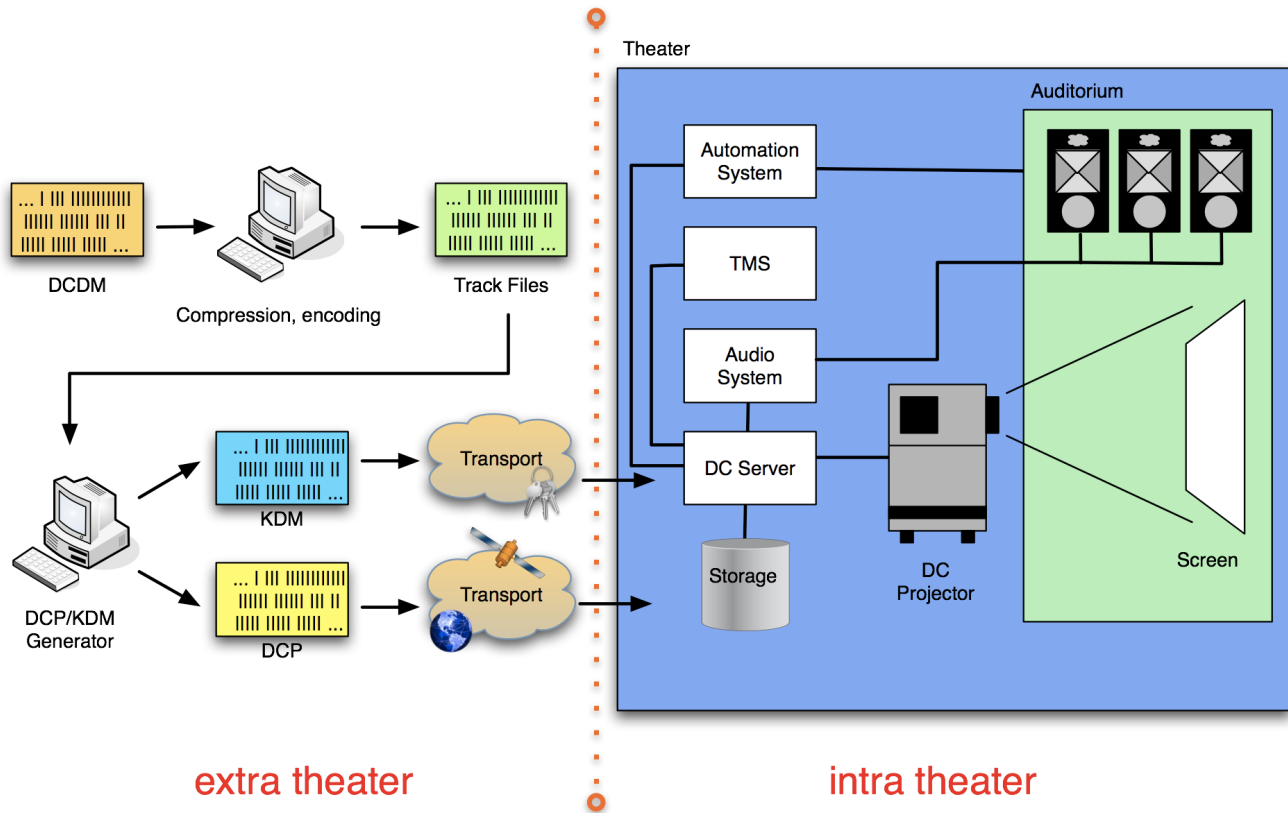

Figure 1.1. Typical DCI Compliant System Configuration

The left side of the diagram shows the *extra-theater* part, which deals with DCP and KDM generation and transport. The right side shows the *intra-theater* part, which shows the individual components of the theater system and how they work together. This test plan will test for proper DCP and KDM formats (*i.e.*, conforming to the Digital Cinema System Specification), for proper transport of the data and for proper processing of valid and malformed DCPs and KDMs. In addition, physical system properties and performance will be tested in order to ensure that the system plays back the data as expected and implements all security measures as required by DCI.

While the above diagram shows what is considered to be a typical configuration allowed by the Digital Cinema System Specification, the [DCI-DCSS] still leaves room for different implementations, for example, some manufacturers may choose to integrate the Media Decryptor blocks into the Imaging Device, or share storage between d-cinema servers.

1.6. Strategies for Successful Testing

In order to successfully execute one of the test sequences given in Part III. Consolidated Test Procedures, the Test Operator must understand the details of many documents and must have assembled the necessary tools and equipment to execute the tests. This document provides all the necessary references to standards, tutorials and tools to orient the technical reader.

As an example, Section 7.5.12 requires a calculation to be performed on a set of measured and reference values to determine whether a Imaging Device's colorimetry is within tolerance. Section C.6 provides an implementation of this calculation, but the math behind the program and the explanation behind the math are not presented in this document. The Test Operator and system designer must read the reference documents noted in Section 7.5.12 (and any references those documents may make) in order to fully understand the process and create an accurate design or present accurate results on a test report.

Preparing a Test Subject and the required documentation requires the same level of understanding as executing the test. Organizations may even choose to practice executing the test internally in preparation for a test by a Testing Organization. The test procedures have been written to be independent of any proprietary tools. In some cases this policy has led to an inefficient procedure, but the resulting transparency provides a reference measurement that can be used to design new tools, and verify results obtained from any proprietary tools a Testing Organization may use.

PART I. PROCEDURAL TESTS

Many tests in this Part rely on the Security Manager promptly making available log records of events. In order to provide a bound on test durations, failure of a Security Managers to make the record of an event available as part of a log report within 5 minutes of the event being recorded is cause to fail the test being conducted.

Chapter 2. Digital Cinema Certificates

Authentication of devices in d-cinema is accomplished using *asymmetric cryptography*. Unlike symmetric cryptography, which uses the same key to encrypt and decrypt data, asymmetric cryptography uses a pair of keys that each reverse the other's cryptographic operations: data encrypted with one key in the key pair can only be decrypted by the other key in the key pair. In such a key pair, there is a *public key* that is distributed freely, and a *private key* that is closely held and protected. Public keys are not easily distinguished from one another because they don't carry any identifying information (they're just really long random numbers). To address this, public keys are distributed with metadata that describes the person or device that holds the private key, called the *subject*. This set of metadata and the public key comprise the *digital certificate*. The standard that defines a digital certificate for d-cinema is [SMPTE-430-2]. It is based on the ITU standard for Public Key Infrastructure, called X.509, and specifies a number of constraints on the X.509v3 standard, such as the X.509 version that can be used and the size of the RSA keys, among other things.

A digital certificate also contains a *signature*, created by generating a message digest of the certificate and then encrypting that message digest with a (usually different) private key. The signature is then added to the certificate, and is used to verify that the certificate is authentic. The holder of the (private) key used to sign a certificate (encrypt the message digest) is known as the *issuer*, and identifying information about the issuer is in the Issuer field of the certificate, linking the issuer to the subject's certificate. Similarly, identifying information about the subject is in the Subject field. In most cases, the issuer and the subject are different. When the issuer and subject are the same, the certificate is known as being *self-signed*. A self-signed certificate is also self-validating, as its own public key is used to validate its signature. When a self-signed certificate is used to sign other certificates, it becomes the *Certificate Authority (CA)* for those certificates. The collection of certificates, from the top CA certificate to the last certificate (known as a *leaf certificate*) are collectively called the *certificate chain*.

Certificate authentication is recursive: in order to verify that a certificate is valid you have to decrypt the signature using the public key in the issuer's certificate. Once that signature is validated, if the issuer's certificate is not self signed then the signature validation process continues up the chain until a self-signed (CA) certificate is validated. A certificate is trusted only if its entire chain is valid.

The test procedures in this chapter are organized into two groups: tests that evaluate a certificate's compliance to [SMPTE-430-2] and tests that evaluate the behavior of devices that decode certificates. The Certificate Decoder tests are in this section because they are not specific to any particular type of system. All d-cinema devices that decode certificates must behave in the manner described by these tests.

2.1. Certificate Structure

The testing procedures that follow make use of the **openssl** cryptographic tools and library. **openssl** is a well known, free, and open source software package available for a number of hardware platforms and operating systems.

Much of the information in a digital certificate can be viewed in a human-readable format using **openssl's** 'text' option. The information presented in the text output can be used to validate a number of certificate requirements, and to validate certificate-related KDM requirements by comparing the values present in the text output to the values in the KDM. The following example illustrates the features of a typical d-cinema leaf certificate:

```

$ openssl x509 -text -noout -in smpte-430-2-leaf-cert.pem 1
Certificate:
  Data:
    Version: 3 (0x2) 2
    Serial Number: 39142 (0x98e6) 3
    Signature Algorithm: sha256WithRSAEncryption 4
    Issuer: O=.ca.example.com, OU=.ra-1b.ra-1a.s430-2.ca.example.com,
           CN=.cc-admin/dnQualifier=0sdCakNi3z6UPCYnogMFITbPMos= 5
  Validity: 6
    Not Before: Mar 9 23:29:52 2007 GMT 7
    Not After : Mar 8 23:29:45 2008 GMT 8
  Subject: O=.ca.example.com, OU=.cc-admin.ra-1b.ra-1a.s430-2.ca.example.com, 9
           CN=SM.ws-1/dnQualifier=H/i8HyVmKEZSFoTeYI2UV9aBiq4= 10
  Subject Public Key Info: 11
    Public Key Algorithm: rsaEncryption 12
    RSA Public Key: (2048 bit) 13
    Modulus (2048 bit): 14
      [hexadecimal values omitted for brevity]
    Exponent: 65537 (0x10001) 15
  X509v3 extensions: 16
    X509v3 Key Usage: 17
      Digital Signature, Key Encipherment, Data Encipherment 18
    X509v3 Basic Constraints: critical 19
      CA:FALSE
    X509v3 Subject Key Identifier: 20
      1F:F8:BC:1F:25:66:28:46:52:16:84:DE:60:8D:94:57:D6:81:8A:AE
    X509v3 Authority Key Identifier: 21
      keyid:D2:C7:42:6A:43:62:DF:3E:94:3C:26:27:A2:03:05:21:36:CF:32:8B
      DirName:/O=.ca.example.com/OU=.ra-1a.s430-2.ca.example.com/
           CN=.ra-1b/dnQualifier=3NMh+Nx9WhnbDcXKK1pu0jX4lsY=
           serial:56:CE

  Signature Algorithm: sha256WithRSAEncryption 22
    [hexadecimal values omitted for brevity]

```

- 1 Openssl command line and arguments to view the certificate text
- 2 The x509 version of the certificate
- 3 The serial number of the certificate.
- 4 The algorithm that was used to sign the certificate.
- 5 Information about the Issuer of the certificate.
- 6 The validity section of the certificate.
- 7 The date the certificate validity period begins.
- 8 The date the certificate validity period ends.
- 9 The Subject Name of the certificate.
- 10 Information about the Subject of the certificate
- 11 Information about the Subject's public key.
- 12 The algorithm used to create the public key
- 13 Information about the RSA public key.
- 14 The modulus value, which is a component of the public key.
- 15 The exponent value, which is a component of the public key
- 16 x509 Version 3 Extensions. These extensions provide more information about the private key, the purposes for which it can be used, and how it is identified.

- 17 Key Usage. These are the actions that the private key can perform.
- 18 The enumerated list of actions that the private key can perform.
- 19 x509 Basic Constraints. These declare whether or not the certificate is a CA certificate, and whether or not there is a path length limitation. Basic Constraints must be marked Critical
- 20 The Subject Key Identifier identifies the public key in the certificate.
- 21 The Authority Key Identifier identifies the Issuer key used to sign the certificate.
- 22 The Signature Algorithm used to sign the certificate.

Example 2.1. D-Cinema Certificate

2.1.1. Basic Certificate Structure

Objective

Verify that the certificate uses the ITU X.509, Version 3 standard with ASN.1 DER encoding as described in [ITU-X509]. Also verify that the *Issuer* and *Subject* fields are present inside the signed part of the certificate.

Procedures

The certificate format and encoding can be verified by using the **openssl** command to display the certificate information as described in Example 2.1, e.g.:

```
$ openssl x509 -text -noout -inform PEM -in <certificate>
```

A correctly formatted and encoded certificate will be displayed as text output by **openssl**. An incorrectly formed certificate will cause **openssl** to display an error. A certificate that causes an error to be displayed by the **openssl** command is incorrectly formed and shall be cause to fail this test.

The version of the certificate and the presence of the *Issuer* and *Subject* fields in the signed portion of the certificate can be verified by viewing **openssl's** text output of the certificate. The version number is indicated by **2** in the example certificate, and the issuer and subject fields are indicated by numbers **5** and **10**, respectively. An x509 version number other than 3, or the absence of either the *Subject* field or the *Issuer* field shall be cause to fail this test.

Supporting Materials

Reference Documents	DCI-DCSS, 9.5.1, 9.8 ITU-X509 SMPTE-430-2
Test Equipment	openssl

2.1.2. SignatureAlgorithm Fields

Objective

Verify that the *SignatureAlgorithm* of the signature and the *SignatureAlgorithm* in the signed portion of the certificate both contain the value "sha256WithRSAEncryption".

Procedures

The signature algorithms of the signature and of the certificate can be verified by using the **openssl** command to display the certificate text as described in Example 2.1, e.g.:

```
$ openssl x509 -text -noout -in <certificate>
```

The signature algorithm of the certificate is indicated by **4** in the example certificate, and the signature algorithm of the signature is indicated by number **22** of the example certificate.

Verify that these fields both contain the value "sha256WithRSAEncryption". If either field contains a different value, this shall be cause to fail this test.

Supporting Materials

Reference Documents	DCI-DCSS, 9.5.1, 9.8 SMPTE-430-2
Test Equipment	openssl

2.1.3. SignatureValue Field

Objective

Verify that the `SignatureValue` field is present outside the signed part of the certificate and contains an ASN.1 Bit String that contains a PKCS #1SHA256WithRSA signature block.

Procedures

The certificate signature value can be verified by using the **openssl** command to display the certificate information as described in [Example 2.1](#), e.g.:

```
$ openssl x509 -text -noout -in <certificate>
```

A correct certificate signature will be displayed as colon separated hexadecimal values in the text output by **openssl**. The signature block, omitted from the example certificate, will be present below the signature algorithm at the bottom of the output below callout number **22** of the example certificate. An incorrect certificate signature will cause **openssl** to display an error. A certificate that causes **openssl** to generate errors is cause to fail this test. A signature value other than sha256WithRSAEncryption is cause to fail this test.

Supporting Materials

Reference Documents	DCI-DCSS, 9.5.1, 9.8 SMPTE-430-2
Test Equipment	openssl

2.1.4. SerialNumber Field

Objective

Verify that the `Serial Number` field is present inside the signed part of the certificate and that it contains a nonnegative integer that is no longer than 64 bits (8 bytes).

Procedures

The certificate serial number can be verified by using the **openssl** command to display the certificate information as described in [Example 2.1](#), e.g.:

```
$ openssl x509 -text -noout -in <certificate>
```

The serial number field is indicated by **3** in the example certificate. Confirm that the serial number is a non-negative integer that is no longer than 64 bits (8 bytes), and that the parenthetical phrase "neg" is not present. A negative serial number or a number larger than 64 bits shall be cause to fail this test.

Supporting Materials

Reference Documents	DCI-DCSS, 9.5.1, 9.8 SMPTE-430-2
Test Equipment	openssl

2.1.5. SubjectPublicKeyInfo Field

Objective

Verify that the Subject Public Key Info field is present inside the signed part of the certificate and that it describes an RSA public key with a modulus length of 2048 bits and a public exponent of 65537.

Procedures

The subject public key info can be verified by using the **openssl** command to display the certificate information as described in [Example 2.1](#), e.g.:

```
$ openssl x509 -text -noout -in <certificate>
```

The Subject Public Key Info is indicated by **11** in the example certificate. The modulus length and the public exponent are indicated by **14** and **15**, respectively.

Verify that the Public Key Algorithm type is rsaEncryption and RSA Public Key is (2048 bit). Failure to meet both requirements is cause to fail this test.

Verify that the Modulus is (2048 bit) and that Exponent is 65537 (0x10001). Any other value for the modulus length or the exponent shall be cause to fail this test.

Supporting Materials

Reference Documents	DCI-DCSS, 9.5.1, 9.8 SMPTE-430-2
Test Equipment	openssl

2.1.6. Deleted Section

The section "RSA Key Format" was deleted. The section number is maintained here to preserve the numbering of subsequent sections.

2.1.7. Validity Field

Objective

Verify that the `validity` field is present inside the signed part of the certificate and contains timestamps in UTC. Timestamps with years up to and including 2049 must use two digits (`UTCTime`) to represent the year. Timestamps with the year 2050 or later must use four digits (`GeneralizedTime`) to represent the year.

Procedures

The presence of the `validity` field can be verified by using the `openssl` command to display the certificate text as described in [Example 2.1](#), e.g.:

```
$ openssl x509 -text -noout -in <certificate>
```

The `validity` field is indicated by callout **6** in the example certificate. Confirm that the field is present and that it contains a "Not Before" value as a UTC timestamp as indicated by **7** of the example certificate and a "Not After" value as a UTC timestamp as indicated by **8** of the example certificate. If the `validity` field is not present, this shall be cause to fail this test.

Verifying the format of the timestamps as either `UTCTime` or `GeneralizedTime` can be accomplished by viewing the ASN.1 sequences of the certificate with `openssl`. Additionally, by using the `grep` command to specify a text string to display, in this case, "TIME", the time formats can be quickly identified:

```
$ openssl asn1parse -in <certificate> |grep TIME
154:d=3 hl=2 l= 13 prim: UTCTIME :070312145212Z
169:d=3 hl=2 l= 13 prim: UTCTIME :270307145212Z
```

Confirm that timestamps up to the year 2049 are in `UTCTime` format, and that timestamps starting with the year 2050 are in `GeneralizedTime` format. Timestamps in `UTCTime` format will be formatted as "YYMMDDhhmmssZ", and Timestamps in `GeneralizedTime` format will have the year coded as "YYYYMMDDhhmmssZ", where "Y" represents the year, "M" represents the month, "D" represents the day, and "h", "m", "s", and "Z" represent hours, minutes, seconds, and the Universal Coordinated Time zone. A timestamp prior to 2049 that is not in UTC format shall be cause to fail this test. A timestamp starting in 2050 or later that is not in `GeneralizedTime` format shall be cause to fail this test.

Supporting Materials

Reference Documents	DCI-DCSS, 9.5.1, 9.8 SMPTE-430-2
Test Equipment	<code>openssl</code>

2.1.8. AuthorityKeyIdentifier Field

Objective

Verify that the `Authority Key Identifier` field is present in the `X509v3 Extensions` section inside the signed part of the certificate.

Procedures

The presence of the `Authority Key Identifier` field can be verified by using the `openssl` command to display the certificate information as described in [Example 2.1](#), e.g.:

```
$ openssl x509 -text -noout -in <certificate>
```

The Authority Key Identifier of the certificate is indicated by **21** in the example certificate. Confirm that this field exists. The absence of the Authority Key Identifier field shall be cause to fail this test.

Supporting Materials

Reference Documents	DCI-DCSS, 9.5.1, 9.8 SMPTE-430-2
Test Equipment	openssl

2.1.9. KeyUsage Field

Objective

Verify that the Key Usage field is present in the X509v3 Extensions section inside the signed part of the certificate.

For signer certificates, verify that only the "Certificate Sign" (`keyCertSign`) flag is true, the "CRL Sign" (`cRLSign`) flag may optionally be present.

For the SM role leaf certificate of a dual certificated MB, verify that the "Certificate Sign" (`keyCertSign`), "CRL Sign" (`cRLSign`), and the "Digital Signature" (`digitalSignature`) flags are false or not present and that the "Key Encipherment" (`keyEncipherment`) flag is true.

For the LS role leaf certificate of a dual certificated MB, verify that the "Certificate Sign" (`keyCertSign`), "CRL Sign" (`cRLSign`), and the "Key Encipherment" (`keyEncipherment`) flags are false or not present, and that the "Digital Signature" (`digitalSignature`) flag is true.

For all leaf certificates not part of a dual certificated MB, verify that the "Certificate Sign" (`keyCertSign`) and "CRL Sign" (`cRLSign`) flags are false or not present, and that the "Digital Signature" (`digitalSignature`), and "Key Encipherment" (`keyEncipherment`) flags are true.

Procedures

The presence of the Key Usage field can be verified by using the **openssl** command to display the certificate information as described in [Example 2.1, e.g.](#):

```
$ openssl x509 -text -noout -in <certificate>
```

The Key Usage field in the certificate is indicated by **17** in the example certificate.

For all certificates, confirm that this field exists. Absence of the Key Usage field shall be cause to fail this test.

For signing certificates, confirm that the key usage listed in the usage list (indicated by **18**) has only "Certificate Sign" (`keyCertSign`), the optional "CRL Sign" (`cRLSign`) flag may be present. Absence of the "Certificate Sign" (`keyCertSign`) flag, or presence of any other flag except for "CRL Sign" (`cRLSign`), shall be cause to fail this test.

For the SM role leaf certificate of a dual certificated MB, confirm that the key usage lists "Key Encipherment" (`keyEncipherment`), and that "Digital Signature" (`digitalSignature`) is absent. Absence of "Key Encipherment" (`keyEncipherment`), or presence of "Digital Signature" (`digitalSignature`), shall be cause to fail this test. Presence of "Certificate Sign" (`keyCertSign`) or "CRL Sign" (`cRLSign`) shall be cause to fail this test.

For the LS role leaf certificate of a dual certificated MB, confirm that the key usage lists "Digital Signature" (`digitalSignature`), and that the "Key Encipherment" (`keyEncipherment`) is absent. Absence of "Digital Signature" (`digitalSignature`), or presence of "Key Encipherment" (`keyEncipherment`), shall be cause to fail this test. Presence of "Certificate Sign" (`keyCertSign`) or "CRL Sign" (`cRLSign`) shall be cause to fail this test.

For all leaf certificates not part of a dual certificated MB, confirm that the key usage lists "Digital Signature" (digitalSignature) and "Key Encipherment" (keyEncipherment). Absence of "Digital Signature" (digitalSignature) and "Key Encipherment" (keyEncipherment) shall be cause to fail this test. Presence of "Certificate Sign" (keyCertSign) or "CRL Sign" (cRLSign) shall be cause to fail this test.

Note that leaf certificates may have other key usages specified, and the presence of other usages not specifically referenced here shall not be a reason to fail this test.

Supporting Materials

Reference Documents	DCI-DCSS, 9.5.1, 9.5.1.1, 9.5.1.2, 9.8 SMPTE-430-2
Test Equipment	openssl

2.1.10. Basic Constraints Field

Objective

Verify that the Basic Constraints field is present in the X509v3 Extensions section of the signed portion of the certificate. For signer certificates, verify that the certificate authority attribute is true (CA:TRUE) and the PathLenConstraint value is present and either zero or positive. For leaf certificates, verify that the certificate authority attribute is false (CA:FALSE) and the PathLenConstraint is absent or zero.

Procedures

The presence of the Basic Constraints field can be verified by using the **openssl** command to display the certificate information as described in [Example 2.1, e.g.](#):

```
$ openssl x509 -text -noout -in <certificate>
```

The Basic Constraints field in the certificate is indicated by **19** in the example certificate. For signing certificates, confirm that this field exists, that the certificate authority value is true (CA:TRUE), and that the path length is present and is a positive integer. For leaf certificates, confirm that the certificate authority value is false (CA:FALSE) and that the path length is absent or zero. The absence of the Basic Constraints field shall be cause to fail this test. For signer certificates, the absence of the CA:TRUE value, or a negative or missing Path Length value shall be cause to fail this test. For leaf certificates, the presence of the CA:TRUE value or the presence of a path length greater than zero shall be cause to fail this test.

Supporting Materials

Reference Documents	DCI-DCSS, 9.5.1, 9.8 SMPTE-430-2
Test Equipment	openssl

2.1.11. Public Key Thumbprint

Objective

Verify that there is exactly one DnQualifier present in the Subject field and that the DnQualifier value is the Base64 encoded thumbprint of the subject public key in the certificate. Also verify that there is exactly one DnQualifier

present in the Subject field and that the DnQualifier value is the Base64 encoded thumbprint of the subject public key in the certificate. Also verify that there is exactly one DnQualifier present in the Issuer field and that the DnQualifier value is the Base64 encoded thumbprint of the issuer's public key.

Procedures

The presence of a single instance of the DnQualifier field can be verified by using the **openssl** command to display the certificate information as described in [Example 2.1, e.g.](#):

```
$ openssl x509 -text -noout -in <certificate>
```

The Subject DnQualifier in the certificate is in the Subject information as indicated by **10** in the example certificate, and the Issuer DnQualifier in the certificate is in the Issuer information as indicated by **5**. Confirm that each of these fields contain only one DnQualifier. Missing DnQualifier values in either of these fields or the presence of more than one DnQualifier in either field shall be cause to fail this test.

The public key DnQualifier must be recalculated to confirm that the DnQualifier value in each of these fields is correct.

The following steps perform this calculation:

1. Extract the public key from the certificate (using **openssl**)
2. Convert the public key from Base64 to binary (using **openssl**)
3. Skip 24 bytes into the binary form of the public key (using **dd**)
4. Calculate the SHA-1 digest over the remaining portion of the binary form of the public key (using **openssl**)
5. Convert the SHA-1 digest value to Base64 (using **openssl**)

The steps above can be performed in sequence by redirecting the output from one step to the next, and using **openssl** and the **dd** command present on most posix compliant operating systems, such as:

```
$ openssl x509 -pubkey -noout -in <certificate> | openssl base64 -d \  
| dd bs=1 skip=24 2>/dev/null | openssl sha1 -binary | openssl base64
```

The resulting value is the calculated DnQualifier of the public key in the input certificate. Confirm that when this calculation is performed on the public key in the subject certificate, the calculated value is equal to the DnQualifier present in the Subject field. Confirm that when this calculation is performed on the public key in the issuer certificate, the calculated value is equal to the DnQualifier present in the Issuer field of the subject certificate. A DnQualifier that does not match the calculated value of the corresponding certificate's public key shall be cause to fail this test.

Supporting Materials

Reference Documents	DCI-DCSS, 9.5.1, 9.8 SMPTE-430-2
Test Equipment	openssl

2.1.12. Organization Name Field

Objective

Verify that exactly one instance of the `OrganizationName` field is present in the `Issuer` and `Subject` fields. Verify that the two `OrganizationName` values are identical.

Procedures

The presence of the `OrganizationName` in the `Subject` and `Issuer` fields can be verified by using the **openssl** command to display the certificate information as described in [Example 2.1](#), e.g.:

```
$ openssl x509 -text -noout -in <certificate>
```

The `OrganizationName` values are in the `Subject` and `Issuer` fields in the certificate as indicated by **5** and **10** in the example certificate. Confirm that the `Organization` name, the value specified as " `O=<organization-name>`", is the same in both fields. Non-identical `Organization` name values in the `Subject` and `Issuer` fields shall be cause to fail this test.

Supporting Materials

Reference Documents	DCI-DCSS, 9.5.1, 9.8 SMPTE-430-2
Test Equipment	openssl

2.1.13. OrganizationUnitName Field

Objective

Verify that exactly one instance of the `OrganizationUnitName` (`OU`) value is present in the `Issuer` and `Subject` fields.

Procedures

The presence of the `OrganizationUnitName` in the `Subject` and `Issuer` fields can be verified by using the **openssl** command to display the certificate information as described in [Example 2.1](#), e.g.:

```
$ openssl x509 -text -noout -in <certificate>
```

The `OrganizationUnitName` values are in the `Subject` and `Issuer` fields in the certificate as indicated by **5** and **10** in the example certificate. The absence of an `OrganizationUnitName` in either the `Subject` or `Issuer` fields of the certificate shall be cause to fail this test.

Supporting Materials

Reference Documents	DCI-DCSS, 9.8 SMPTE-430-2
Test Equipment	openssl

2.1.14. Entity Name and Roles Field

Objective

Verify that the `CommonName` (CN) is present exactly once in both the `Subject` and `Issuer` fields. Also verify that the `CommonName` fields contain a physical identification of the entity (*i.e.*, make, model, or serial number, for devices). For leaf certificates (*i.e.*, certificate authority is set to `False`), verify that at least one role is specified and that it is the role expected for the certificate.

Procedures

The presence of the `CommonName` in the `Subject` and `Issuer` fields can be verified by using the `openssl` command to display the certificate information as described in [Example 2.1](#), *e.g.*:

```
$ openssl x509 -text -noout -in <certificate>
```

The `CommonName` values are in the `Subject` and `Issuer` fields in the certificate as indicated by **5** and **10** in the example certificate. Confirm that the `CommonName`, the value specified as "`CN=<common-name>`" is present only once and that it contains information that identifies the entity. For leaf certificates, confirm that the common name specifies at least one role and that it is correct for the certificate. The absence of the `CommonName` value in either the `Subject` or `Issuer` fields shall be cause to fail this test. For leaf certificates, the absence of a role designation shall be cause to fail this test.

Supporting Materials

Reference Documents	DCI-DCSS, 9.5.1, 9.8 SMPTE-430-2
Test Equipment	<code>openssl</code>

2.1.15. Unrecognized Extensions

Objective

Verify that any X.509v3 extensions in the certificate that are not specified in [SMPTE-430-2] (unrecognized extensions) are not marked critical.

Procedures

The list of X.509v3 extensions in a certificate can be viewed by using the `openssl` command to display the certificate information as described in [Example 2.1](#), *e.g.*:

```
$ openssl x509 -text -noout -in <certificate>
```

For signer certificates (certificates that have `CA:TRUE`), of the X.509v3 extensions listed in the certificate, "Basic Constraints" (indicated by **19**) must be marked critical. "Basic Constraints" may be marked critical for leaf certificates. "Key Usage" and "Authority Key Identifier" (indicated by **17**) may be marked critical. No other unrecognized X.509v3 extensions may be marked critical. A signer certificate with a "Basic Constraints" section that is not marked critical shall be cause to fail this test. A Certificate that has any X.509v3 extension marked critical other than "Basic Constraints", "Key Usage" or "Authority Key Identifier" shall be cause to fail this test.

Supporting Materials

Reference Documents	DCI-DCSS, 9.5.1, 9.8 SMPTE-430-2
----------------------------	-------------------------------------

Test Equipment

openssl

2.1.16. Signature Validation

Objective

Using the issuer's public key, verify that the signature contained in the certificate is valid.

Procedures

For this operation to be successful, validation must be performed down the certificate chain, from the self-signed root certificate (the CA) to the leaf certificate being validated. Certificate chain validation is recursive, so as each certificate in the chain is validated it is included as part of the validation of the next certificate. With **openssl**, this results in a file that contains the root certificate and, incrementally, each of the signer certificates of certificate chain of the leaf certificate. This file is then used to validate the signature on the leaf certificate. A certificate chain containing three certificates can be validated by following these steps:

1. Verify that the CA certificate signature is valid
2. Verify that the CA's signature on the signer's certificate is valid.
3. Verify that the signer's signature on the leaf certificate is valid.

This example uses **openssl** to validate each certificate, and the unix command 'cat' to append each successive certificate to a single file. This file is specified to **openssl** using the **-CAfile** option.

```
$ openssl verify -CAfile caroot.pem caroot.pem
caroot.pem: OK
$ cp caroot.pem certchain.pem
$ openssl verify -CAfile certchain.pem signer.pem
signer.pem: OK
$ cat signer.pem >> certchain.pem
$ openssl verify -CAfile certchain.pem leaf.pem
leaf.pem: OK
```

Error messages from **openssl** indicate that a certificate in the chain did not validate, and that the chain is not valid. Error messages that indicate that the certificate chain is not valid shall be cause to fail this test.

Supporting Materials

Reference Documents	DCI-DCSS, 9.5.1, 9.8 SMPTE-430-2
Test Equipment	openssl

2.1.17. Certificate Chains

Objective

For a given certificate chain:

- Verify that the certificate chain is complete, *i.e.*, for each certificate specified in an Issuer field, there is a corresponding certificate whose Subject field matches that Issuer field.
- Verify that, for each certificate in the chain, the validity period of any child certificate is completely contained within the validity period of the parent certificate.
- Verify that the root certificate (*i.e.*, a self-signed certificate where the CA-flag is true) is a valid root certificate.

Procedures

A complete certificate chain starts with a leaf certificate and ends with a self-signed (CA root) certificate. Between the leaf certificate and the CA root certificate there should be one or more signer certificates. A leaf certificate is signed by a signer certificate, and the signer certificate is identified by its DnQualifier in the "Issuer" field of the leaf certificate. In a chain of three certificates, the signer certificate is in turn signed by the CA root certificate, which is similarly identified by its DnQualifier in the Issuer field of the signer's certificate. The CA root certificate is self-signed and has its own DnQualifier in both the Subject and Issuer fields.

To verify that the certificate chain is complete, confirm that the certificates corresponding to the Issuer DnQualifiers of each of the certificates is present, as explained in [Section 2.1.11: Public Key Thumbprint](#). A certificate chain that does not contain all of the certificates matching the DnQualifiers specified in the Issuer fields of the certificates means the chain is not complete and shall be cause to fail this test.

The validity period of a certificate can be viewed using the procedure described in [Section 2.1.7: Validity Field](#). Confirm that for each certificate in the chain, the signer certificate's validity period completely contains the validity period of the signed certificate. A certificate that has a validity period that extends beyond the validity period of its signer (either starting before, or ending after, the validity period of its signer) shall be cause to fail this test.

To confirm that the CA root certificate is a valid root certificate:

1. Verify that the DnQualifier in the Issuer field is the same as the DnQualifier in the Subject field as described in [Section 2.1.11: Public Key Thumbprint](#).
2. Confirm that the Certificate Authority value in the Basic Constraints field is true and the path length value is a number, zero or greater, as described in [Section 2.1.10: Basic Constraints Field](#).
3. Confirm that the X.509v3 Key Usage contains "Certificate Sign" as described in [Section 2.1.9: KeyUsage Field](#).

A CA certificate that does not have a non-negative path length of zero or greater, or that does not have the basic constraints extension marked critical and containing CA:TRUE, shall be cause to fail this test.

A CA Root certificate that is not self-signed shall be cause to fail this test.

Supporting Materials

Reference Documents	DCI-DCSS, 9.5.1, 9.8 SMPTE-430-2
Test Equipment	openssl

2.2. Certificate Decoder Behavior

2.2.1. ASN.1 DER Encoding Check

Objective

Verify that a certificate is rejected by the decoding device if it contains syntax errors or does not conform to the ASN.1 DER (Distinguished Encoding Rules) format.

Procedures

For the malformed certificate below, perform an operation with the Test Subject using a malformed certificate. Verify that the operation fails. A successful operation using a malformed certificate is cause to fail this test.

1. A certificate encoded as BER (*chain-c3-BER-enc*, *IMB-chain-a3-BER-enc*)

Supporting Materials

Reference Documents	DCI-DCSS, 9.5.1, 9.8 SMPTE-430-2
Test Materials	<i>chain-c3-BER-enc</i> <i>chain-c1-root</i> <i>chain-c3-root</i> <i>IMB-chain-a3-BER-enc</i> <i>chain-a3-root</i> <i>chain-b1-roo</i>

2.2.2. Missing Required Fields

Objective

Verify that certificates with missing required fields are rejected by a Test Subject.

Procedures

For each of the malformations below, perform an operation on the device with the certificate that contains that malformation. Verify that the operation fails. A successful operation using a malformed certificate is cause to fail this test.

- missing SignatureAlgorithm field (i.e, *chain-c3-no-saf*, *chain-a3-no-saf*) - reject
- missing SignatureValue field (*chain-c3-no-svf*, *chain-a3-no-svf*) - reject
- missing Version field (*chain-c3-no-ver*, *chain-a3-no-ver*) - reject
- missing SerialNumber field (*chain-c3-no-sn*, *chain-a3-no-sn*) - reject
- missing Signature field (*chain-c3-no-sig*, *chain-a3-no-sig*) - reject

- missing Issuer field (*chain-c3-no-issuer, chain-a3-no-issuer*) - reject
- missing Subject field (*chain-c3-no-subject, chain-a3-no-subject*) - reject
- missing SubjectPublicKeyInfo field (*chain-c3-no-spki, chain-a3-no-spki*) - reject
- missing Validity field (*chain-c3-no-val-f, chain-a3-no-val-f*) - reject
- missing AuthorityKeyIdentifier field (*chain-c3-no-aki-f, chain-a3-no-aki-f*) - reject
- missing KeyUsage field (*chain-c3-no-keyuse, chain-a3-no-keyuse*) - reject
- missing BasicConstraint field (*chain-c3-no-basic, chain-a3-no-basic*) - reject

Supporting Materials

Reference Documents	DCI-DCSS, 9.5.1, 9.8 SMPTE-430-2
Test Materials	<i>chain-c3-no-saf</i> <i>chain-c3-no-svf</i> <i>chain-c3-no-ver</i> <i>chain-c3-no-sn</i> <i>chain-c3-no-sig</i> <i>chain-c3-no-issuer</i> <i>chain-c3-no-subject</i> <i>chain-c3-no-spki</i> <i>chain-c3-no-val-f</i> <i>chain-c3-no-aki-f</i> <i>chain-c3-no-keyuse</i> <i>chain-c3-no-basic</i> <i>chain-c1-root</i> <i>chain-c3-root</i> <i>chain-a3-no-aki-f</i> <i>chain-a3-no-basic</i> <i>chain-a3-no-issuer</i> <i>chain-a3-no-keyuse</i> <i>chain-a3-no-saf</i> <i>chain-a3-no-sig</i> <i>chain-a3-no-sn</i> <i>chain-a3-no-spki</i> <i>chain-a3-no-subject</i> <i>chain-a3-no-svf</i> <i>chain-a3-no-val-f</i> <i>chain-a3-no-ver</i>

2.2.3. PathLen Check

Objective

Verify that, if the Certificate Authority attribute of the BasicConstraint field is True, the PathLenConstraint value is present and is either zero or positive. Verify that if the certificate authority attribute of the BasicConstraint field is False, the PathLenConstraint field is absent or set to zero.

Procedures

1. Perform an operation on the Test Subject using a leaf certificate with a PathLen greater than zero (0). Verify that the operation fails. A successful operation using a certificate with an incorrect Path Length is cause to fail this test.
2. Perform an operation on the Test Subject using a leaf certificate with a PathLen that is negative. Verify that the operation fails. A successful operation using a certificate with an incorrect Path Length is cause to fail this test.
3. Perform an operation on the Test Subject using a signer certificate that does not contain a PathLen (PathLen absent). Verify that the operation fails. A successful operation using a certificate with an incorrect Path Length is cause to fail this test.
4. Perform an operation on the Test Subject using a signer certificate that contains a PathLen that is negative. Verify that the operation fails. A successful operation using a certificate with an incorrect Path Length is cause to fail this test.

Supporting Materials

Reference Documents	DCI-DCSS, 9.5.1, 9.8 SMPTE-420-2
Test Materials	<i>chain-c3-path-1</i> <i>chain-c3-path-2</i> <i>chain-c3-path-3</i> <i>chain-c3-path-4</i> <i>chain-c3-path-5</i> <i>chain-c3-path-6</i> <i>chain-c3-path-7</i> <i>chain-c3-root</i> <i>chain-a3-path-1</i> <i>chain-a3-path-2</i> <i>chain-a3-path-3</i> <i>chain-a3-path-4</i> <i>chain-a3-path-5</i> <i>chain-a3-path-6</i> <i>chain-a3-path-7</i> <i>chain-a3-root</i>

2.2.4. OrganizationName Match Check

Objective

Verify that the certificate is rejected by the device if the `OrganizationName` in the subject and issuer fields do not match.

Procedures

Perform an operation on the device with a certificate that has mismatched `OrganizationName` values in the Subject and Issuer fields. Verify that the operation fails. A successful operation using a malformed certificate is cause to fail this test.

Supporting Materials

Reference Documents	DCI-DCSS, 9.5.1, 9.8 SMPTE-420-2
Test Materials	<i>chain-c3-org-name</i> <i>chain-c3-root</i> <i>chain-a3-org-name</i> <i>chain-a3-root</i>

2.2.5. Certificate Role Check

Objective

Verify that when the validation context includes a desired role, a Test Subject rejects a leaf certificate with a role that is different than the role expected.

Procedures

Perform an operation on the Test Subject using a certificate with a role that is not permitted for the operation. Verify that the operation fails. A successful operation using a certificate with an incorrect role is cause to fail this test.

- Certificate Authority is False and no role specified in `CommonName` (*chain-c3-role-1*, *chain-a3-role-1*) - reject
- Distribution Root Certificate without a distributor role, SPB root Certificate with a role other than SMS role (*chain-c3-role-2*, *chain-a3-role-2*) - reject

Supporting Materials

Reference Documents	DCI-DCSS, 9.5.1, 9.8 SMPTE-420-2
Test Materials	<i>chain-c3-role-1</i> <i>chain-c3-role-2</i> <i>chain-c3-root</i> <i>chain-a3-role-1</i> <i>chain-a3-role-2</i> <i>chain-a3-root</i>

2.2.6. Validity Date Check

Objective

Verify that the certificate is rejected if it is not valid at the desired time (according to the validation context, e.g., time of playback).

Procedures

Perform an operation on the device with a certificate that is not valid. Verify that the operation fails. A successful operation using a certificate at a time outside of its validity period is cause to fail this test.

Supporting Materials

Reference Documents	DCI-DCSS, 9.5.1, 9.8 SMPTE-420-2
Test Materials	<i>chain-c3-date-exp</i> <i>chain-c3-root</i> <i>chain-a3-date-exp</i> <i>chain-a3-root</i>

2.2.7. Signature Algorithm Check

Objective

Verify that a certificate is rejected by a Test Subject if the signature algorithms in the certificate body and the signature are not sha256WithRSAEncryption.

Procedures

Perform an operation on the device with a certificate that has mismatched or incorrect signatures for each of the following types of signature errors. Verify that the operation fails. A successful operation using an incorrectly signed certificate is cause to fail this test.

- Signature algorithm of the signature not sha256WithRSAEncryption (*chain-c3-osig-type, chain-a3-iosig-type*) - reject
- Signature algorithm of the certificate not sha256WithRSAEncryption (*chain-c3-isig-type, chain-a3-isig-type*) - reject
- Signature algorithms identical, but not sha256WithRSAEncryption (*chain-c3-iosig-type, chain-a3-osig-type*) - reject

Supporting Materials

Reference Documents	DCI-DCSS, 9.5.1, 9.8 SMPTE-420-2
Test Materials	<i>chain-c3-osig-type</i>

chain-c3-isig-type
chain-c3-iosig-type
chain-c3-root
chain-a3-isig-type
chain-a3-iosig-type
chain-a3-root

2.2.8. Public Key Type Check

Objective

Verify that the certificate is rejected if the subject's Public Key is not a 2048 bit RSA key with an exponent of 65537.

Procedures

For each of the types of incorrect public keys below, perform an operation on the device with the certificate that has an public key that is not correct. Verify that the operation fails. A successful operation using a certificate with an incorrect public key is cause to fail this test.

- Public Key not an RSA Key (*chain-c3-no-rsa*, *chain-a3-no-rsa*) - reject
- RSA Public Key Length only 1024 bit (*chain-c3-short-rsa*, *chain-a3-short-rsa*) - reject
- Public Key Exponent other then 65537 (*chain-c3-bad-exp*) - reject

Supporting Materials

Reference Documents	DCI-DCSS, 9.5.1, 9.8 SMPTE-420-2
Test Materials	<i>chain-c3-no-rsa</i> <i>chain-c3-short-rsa</i> <i>chain-c3-bad-exp</i> <i>chain-c3-root</i> <i>chain-a3-no-rsa</i> <i>chain-a3-bad-exp</i> <i>chain-a3-short-rsa</i> <i>chain-a3-root</i>

2.2.9. Issuer Certificate Presence Check

Objective

Verify that the certificate is rejected if the issuer's certificate cannot be located by looking it up using the value of the AuthorityKeyIdentifier X.509v3 extension.

Procedures

Perform an operation on the Test Subject using certificates that do not include the certificate's signer specified by the `AuthorityKeyIdentifier`. Verify that the operation fails. A successful operation using a certificate without the certificate signer present is cause to fail this test.

Supporting Materials

Reference Documents	DCI-DCSS, 9.5.1, 9.8 SMPTE-420-2
Test Materials	<i>KDM without AuthorityKey certificate</i>

Chapter 3. Key Delivery Messages

This chapter contains tests for Key Delivery Messages (KDM). The test procedures in this chapter are organized into three groups: tests that evaluate a KDM's compliance to [SMPTE-430-1], tests that evaluate a KDM's compliance to [SMPTE-430-3], and tests that evaluate the behavior of devices that decode KDMs. The KDM Decoder tests are in this section because they are not specific to any particular type of system. All d-cinema devices that decode KDMs must behave in the manner described by these tests.

Before diving in to testing KDM files, we will first introduce XML and provide some examples of KDM documents.

3.1. eXtensible Markup Language

XML is a file metaformat: a file format for creating file formats. Many of the files that comprise a d-cinema composition (*e.g.*, a feature or trailer), are expressed in XML. While the various d-cinema file formats represent different concepts within the d-cinema system, the arrangement of data within the files is syntactically similar for those files that use XML. This section will provide an overview of XML as used for d-cinema applications. Readers looking for more detailed technical information are referred to the home of XML at <http://www.w3.org>.

3.1.1. XML Documents

The main unit of data storage in an XML document is the XML *element*. XML elements are expressed in a document using *tags*; strings of human-readable text enclosed between less-than (<) and greater-than (>) characters. An XML *document* is an element that is meant to be interpreted as a complete unit. Every XML document consists of a single XML element having zero or more (usually hundreds more) elements inside. XML documents may be stored as files, transmitted over networks, etc. The following example shows a very simple XML element, rendered as a single tag

```
<Comment/>
```

By itself, this XML element is a complete, though very uninteresting XML document.

To be more useful, our example element needs some data, or *content*. XML content may include unstructured text or additional XML elements. Here we have expanded the element to contain some text:

```
<Comment>The quick brown fox...</Comment>
```

Notice that when an XML element has content, the content is surrounded by two tags, in this case `<Comment>` and `</Comment>`. The former is an *opening* tag, the latter a *closing* tag.

We now have some data inside our element. We could help the reader of our example XML document by indicating the language that the text represents (these same characters could of course form words from other languages). The language of the text is *metadata*: in this case, data about the text. In XML, metadata is stored as sets of key/value pairs, or *attributes*,

inside the opening tags. We will add an attribute to our example element to show some metadata, in this case we are telling the reader that the text is in English:

```
<Comment language="en">The quick brown fox...</Comment>
```

The following example shows an actual d-cinema data structure (there is no need to understand the contents of this example as this particular structure is covered in more detail in [Section 4.2.1.](#)):

```
<?xml version="1.0" encoding="UTF-8" standalone="no" ?>
<PackingList xmlns="http://www.smpte-ra.org/schemas/429-8/2007/PKL">
  <Id>urn:uuid:59430cd7-882d-48e8-a026-aef4b6253dfc</Id>
  <AnnotationText>Perfect Movie DCP</AnnotationText>
  <IssueDate>2007-07-25T18:21:31-00:00</IssueDate>
  <Issuer>user@host</Issuer>
  <Creator>Packaging Tools v1.0</Creator>
  <AssetList>
    <Asset>
      <Id>urn:uuid:24d73510-3481-4ae5-b8a5-30d9eeced9c1</Id>
      <Hash>AXufMKY7NyZcfSXQ9sCZls5dSyE=</Hash>
      <Size>32239753</Size>
      <Type>application/mxf</Type>
      <AnnotationText>includes M&E</AnnotationText>
    </Asset>
  </AssetList>
</PackingList>
```

Example 3.1. Packing List Example (Partial)

3.1.2. XML Schema

You may have noticed that the basic structure of XML allows the expression of almost unlimited types and formats of information. Before a device (or a person) can read an XML document and decide whether it is semantically correct, it must be possible for the reader to know what the document is expected to contain.

The XML standard dictates some initial requirements for XML documents. The document shown in [Example 3.1](#) above illustrates some of these requirements:

1. Element tags must be correctly nested: an element must be closed in the same scope in which it was opened. For example, the following XML fragment shows incorrect nesting of the `Element3` element (it should close before `Element2` closes, not after).

```
<Element1>
  <Element2>
    <Element3>
  </Element2>
</Element3>
</Element1>
```

2. The document may not contain special characters in unexpected places. For example, the `&`, `<` and `>` characters may not appear except in certain cases. Special encodings must be used to use these characters literally within an XML document.

A document which meets these requirements is said to be *well formed*. All XML documents must be well formed. An XML *parser* (a program that reads XML syntax) will complain if you give it XML that is not well-formed. Well-formedness, however, does not help us understand *semantically* what's in an XML document. To know the meaning of a particular XML structure, we have to have a description of that structure.

The structure and permitted values in an XML document can be defined using XML Schema. There are other languages for expressing the content model of an XML document, but XML Schema is the standard used by the SMPTE specifications for d-

cinema. XML Schema is a language, expressed in XML, which allows the user to define the names of the elements and attributes that can appear in an XML document. An XML Schema can also describe the acceptable contents of and combinations of the XML elements.

Given an XML Schema and an XML document, a *validating* XML parser will report not only errors in syntax but also errors in the use and contents of the elements defined by the schema. Throughout this document, we will use the **schema-check** program (see [Section C.3](#)) to test XML documents. The command takes the instance document and one or more schema documents as arguments

```
$ schema-check <input-file> smpte-430-3.xsd
```

If this command returns without errors, the XML document can be said to be both well-formed and *valid*

Some XML documents are defined using more than one schema. In these cases, you can supply the names of any number of schemas on the command line:

```
$ schema-check <input-file> smpte-430-3.xsd smpte-430-1.xsd
```

3.1.3. XML Signature Validation

XML Signature is a standard for creating and verifying digital signatures on XML documents. Digital signatures are used to allow recipients of Composition Playlists, Packing Lists and Key Delivery Messages (KDM) to *authenticate* the documents; to prove that the documents were signed by the party identified in the document as the document's signer, and that the documents have not been modified or damaged since being signed.

The **checksig** program (distributed with the XML Security library) can be used to test the signature on an XML document. The program is executed with the name of a file containing a signed XML document:

```
$ checksig test-kdm.xml  
Signature verified OK!
```

Example 3.2. checksig execution

The program expects that the first certificate in the `<KeyInfo>` element is the signer. This has two implications:

1. The program will fail if the signer is not the first (SMPTE standards allow any order)
2. The program does not check the entire certificate chain

To address the first issue, the **dsig_cert.py** program (see [Section C.8](#)) can be used to re-write the XML document with the signer's certificate first in the `<KeyInfo>` element. This is demonstrated in the following example:

```
$ dsig_cert.py test-kdm.xml > tmp.xml  
$ checksig tmp.xml  
Signature verified OK!
```

Example 3.3. dsig_cert.py execution

The second issue is addressed by extracting the certificates from the document's XML Signature data and validating them directly with **openssl**. This procedure is the subject of the next section.

3.1.3.1. Extracting Certificates from an XML Document

In order to test certificates separately from the XML document in which they are embedded, this procedure will manually extract them into separate PEM files (see [RFC-1421]). A PEM file contains a certificate (more than one if desired, but we're not going to do that just yet) as a DER-encoded binary string which is then encoded using Printable Encoding (see [RFC-1421]). The encoded text is prefixed by the string `-----BEGIN CERTIFICATE-----` followed by a

newline. The encoded text is followed by the string -----END CERTIFICATE----- . An example of this format can be seen below. Note that the Printable Encoding has newlines after every 64 characters.

```
-----BEGIN CERTIFICATE-----
MIIEEdzCCA1+gAwIBAgICNBowDQYJKoZIhvcNAQELBQAwwYQxGTAXBgNVBAoTEC5j
YS5jaW5lY2VydC5jb20xLDAqBgNVBAsTIy5yYS0xYi5yYS0xYi5yYS0xYi5yYS0x
Y2luZWNlcnQuY29tMRIwEAYDVQQDEwkuY2MtYWRTaW4xJTAjBgNVBC4THGNwSmxw
NDBCM0hqSG9kOG9JWnpsVi9DU0xmND0wIBcNMDcwMTE1MjI0TQ0WhgPMjAw0DAX
MTUyYmJjQ5NDJmIjEGLMRkwFwYDVQQKEwAuY2EuY2luZWNlcnQuY29tMTUwMwYDVQQL
EYwuY2MtYWRTaW4ucmEtMwIucmEtMwEuczQzMC0yLmNhLmNpbmVjZXJ0LmNvbTEQ
MA4GA1UEAxMHU00ud3MtMTE1MCMGA1UELhMcdC8zQ2xNWjdiQWRGUhnam1TRTFn
NGY4NUhNPTCCASiWdQYJKoZIhvcNAQEBBQADggEPADCCAQoCggEBA0BejWa3Lg+Y
uvTYhCaFy0ET6zH6XRb3rLRrLbeMrrTuUMCX0YSmA7m3Z01Bd/HQrJxyq6hJmPGu
auxwWiF4w+AajBRp4eSiAt8srACcEmUyqGHwPloaKVEaHXS0Y8gJp1kZwqGwoR40
RQusfAb2/L76+rLMUyAcOJuR6k4k0BW3bjEE4E76KKR4k5K580d7uFf5G86GhGfU
AfXHJXboqzHnxQHaMldkNAsSxkWrW8GrX43+ZZUHM2ZKe0Ps/9g2gCRZ6eYaIm4
UF+szH0EUY0Mbx4poqn+SZFrUWtEoWcDM6PSTTgCQV0Q1BtzD1LBQoNQGOJcd73N
9f5MfGioWmKCAwEAa0B5zCB5DALBgNVHQ8EBAMCBLAWDAYDVR0TAQH/BAIwADAd
BgNVHQ4EFgQUt/3CLMz7bAdFRxgjmSE1g4f85HMwgacGA1UdIwSbnzCBnIAUcPJl
p40B3HjHod8oIZz1V/CSL6hf6R9MHsxGTAXBgNVBAoTEC5jYS5jaW5lY2VydC5j
b20xJjAkBgNVBAsTHS5yYS0xYi5yYS0xYi5yYS0xY2luZWNlcnQuY29tMQ8wDQYD
VQQDEwYucmEtMwIucmEtMwEuczQzMC0yLmNhLmNpbmVjZXJ0LmNvbTEQMA4GA1UE
AxMHU00ud3MtMTE1MCMGA1UEHjAFQsyoKto7+WBeF9HuCRpKkxk
6qMgXzgAfJFRk/pi7CjnfjxvWukJq4HWgWHPXsGFf/RTp08naV1UHNe71sDYV2Fb
MOSFRi20rRwZEx09SBKQHLZ7ZdLU+6GIHXKjmp9DioFUN0qvZPQnvwG/Cm084CpG
K14ktxt0ghczEiJk2KISsg0U6NK4cmcFfMjuklTwmD5C6TvaawkvcNJQcldjUw
Twbvd+Edf9wkHnVBERR9lbcGWr16C5BVQZtFBJAU++3guL/4Qn4lkeU/gmR6o99S
UQ+T344CBSIy06ztiWZiuxo0NoXfy12DTSepB+QShmuhsScrfv0Q9bB5hw==
-----END CERTIFICATE-----
```

Example 3.4. An X.509 certificate in PEM format

Within an XML document signed using XML Signature, certificates are stored in <dsig:X509Certificate> elements. These elements can be found at the end of the document, within the </dsig:Signature> element. The encoding method for storing certificate data in XML Signature is virtually identical to PEM. The Base64 encoding (see [RFC-2045]) uses the same mapping of binary data to text characters, but the line length is not limited as with PEM.

It is a relatively easy task to use a **Text Editor** to copy and paste certificate data from an XML document:

1. Open a new **Text Editor** window, and paste -----BEGIN CERTIFICATE-----, then press the Enter key. Note that the number of '-' (dash) characters on either side of the BEGIN CERTIFICATE label is five (5).
2. Copy the content of the selected <dsig:X509Certificate> element (but not the element tags) from the KDM and paste it into the new editor window. The cursor should now be positioned at the last character of the certificate; press the Enter key.
3. Paste -----END CERTIFICATE----- at the end of the new editor window and press the Enter key.
4. Note again that Printable Encoding lines in PEM format files must be no more than 64 characters in length. If the Base64 certificate string copied from the KDM contains long lines, manually break the lines using the cursor and the Enter key.
5. Save the editor's contents to a file, usually with a .pem suffix.

In most cases the procedure given above can be automated using the **dsig_extract.py** program (see [Section C.9](#)). As shown below, the `-p` option can be used to provide a prefix for the automatically-generated filenames. In this example, the input document contained four certificates.

```
$ dsig_extract.py -p my_prefix_ test-kdm.xml
$ ls my_prefix_*
my_prefix_1.pem
my_prefix_2.pem
my_prefix_3.pem
my_prefix_4.pem
```

Example 3.5. dsig_extract.py execution

You can test that the certificate has been correctly extracted by using **openssl** to view the contents of the certificate file:

```
$ openssl x509 -text -noout -in <certificate-file.pem>
```

The output from this command should look similar to [Example 2.1](#)

To validate a complete chain of extracted certificates, use the procedure in [Section 2.1.16](#).

3.2. Key Delivery Message Example

The Key Delivery Message (KDM) is an XML document that contains cryptographic information necessary to reproduce an encrypted composition. A KDM also contains metadata about the cryptographic information, such as the validity period and the associated Composition Playlist (CPL). The format of the KDM file is specified by [SMPTE-430-1]. A KDM is a type of Extra-Theater Message (ETM), as specified by [SMPTE-430-3].

The following examples show the elements of the KDM that will be examined during the procedures. Each example is followed by a list of descriptive text that describes the various features of the KDM called out in the examples. These features will be referred to from the test procedures.

```

<?xml version="1.0" encoding="UTF-8" standalone="no"?> 1
<DCinemaSecurityMessage xmlns="http://www.smpte-ra.org/schemas/430-3/2006/ETM" 2
  xmlns:dsig="http://www.w3.org/2000/09/xmldsig#" xmlns:enc="http://www.w3.org/2001/04/xmlenc#">
  <AuthenticatedPublic Id="ID_AuthenticatedPublic"> 3
  <MessageId>urn:uuid:b80e668c-a175-4bc7-ae48-d3a19c8fce95</MessageId> 4
  <MessageType>http://www.smpte-ra.org/430-1/2006/KDM#kdm-key-type</MessageType> 5
  <AnnotationText>Perfect Movie KDM</AnnotationText> 6
  <IssueDate>2007-07-24T17:42:58-00:00</IssueDate> 7
  <Signer> 8
    <dsig:X509IssuerName>dnQualifier=wBz3yptkPxbHI/\+LUUeH5R6rQfI=,CN=.cc-admin-x,
      OU=.cc-ra-1a.s430-2.ca.example.com,0=.ca.example.com</dsig:X509IssuerName>
    <dsig:X509SerialNumber>6992</dsig:X509SerialNumber>
  </Signer>
  <RequiredExtensions>
    <KDMRequiredExtensions xmlns="http://www.smpte-ra.org/schemas/430-1/2006/KDM">
      <Recipient> 9
        <X509IssuerSerial>
          <dsig:X509IssuerName>dnQualifier=wBz3yptkPxbHI/\+LUUeH5R6rQfI=,CN=.cc-admin-x,
            OU=.cc-ra-1a.s430-2.ca.serverco.com,0=.ca.serverco.com</dsig:X509IssuerName>
          <dsig:X509SerialNumber>8992</dsig:X509SerialNumber> 10
        </X509IssuerSerial>
        <X509SubjectName>dnQualifier=83R40icxCejFRR6Ij6iwdf2faTY=,CN=SM.x_Mastering,
          OU=.cc-ra-1a.s430-2.ca.example.com,0=.ca.example.com</X509SubjectName> 11
        </Recipient>
        <CompositionPlaylistId> 12
          urn:uuid:20670ba3-d4c7-4539-ac3e-71e874d4d7d1
        </CompositionPlaylistId>
        <ContentTitleText>Perfect Movie</ContentTitleText> 13
        <ContentKeysNotValidBefore>2007-07-24T17:42:54-00:00</ContentKeysNotValidBefore> 14
        <ContentKeysNotValidAfter>2007-08-23T17:42:54-00:00</ContentKeysNotValidAfter> 15
        <AuthorizedDeviceInfo>
          <DeviceListIdentifier>urn:uuid:d47713b9-cde1-40a9-98fe-22ef172723d0</DeviceListIdentifier>
          <DeviceList> 16
            <CertificateThumbprint>jk4Z8haFhqGAVbClW65jV50ib4=</CertificateThumbprint> 17
          </DeviceList>
        </AuthorizedDeviceInfo>
        <KeyIdList> 18
          <TypedKeyId>
            <KeyType scope="http://www.smpte-ra.org/430-1/2006/KDM#kdm-key-type">MDIK</KeyType> 19
            <KeyId>urn:uuid:15e929b3-1d86-40eb-875e-d21c916fdd3e</KeyId> 20
          </TypedKeyId>
          <TypedKeyId>
            <KeyType scope="http://www.smpte-ra.org/430-1/2006/KDM#kdm-key-type">MDAK</KeyType>
            <KeyId>urn:uuid:ca8f7756-8c92-4e84-a8e6-8fab898934f8</KeyId>
          </TypedKeyId>
          [remaining key IDs omitted for brevity]
        </KeyIdList>
        <ForensicMarkFlagList> 21
          <ForensicMarkFlag>
            http://www.smpte-ra.org/430-1/2006/KDM#mrkflg-audio-disable
          </ForensicMarkFlag>
        </ForensicMarkFlagList>
      </KDMRequiredExtensions>
    </RequiredExtensions>
  <NonCriticalExtensions/>
</AuthenticatedPublic>

```

- 1** XML Declaration. This specifies the version of the XML standard to which the document conforms, and the character encoding of the document
- 2** The root DCinemaSecurityMessage element. This element contains the XML namespace declaration for a KDM as specified in [SMPTE-430-1].
- 3** The beginning of the AuthenticatedPublic section of the KDM.
- 4** The Unique Universal ID (UUID) of the KDM. This is used to uniquely identify the asset map

- 5 The type of message, in this case a KDM.
- 6 An annotation text describing the contents or purpose of the KDM.
- 7 The date the KDM was issued.
- 8 The portion of the KDM that holds information about the certificate used to sign the KDM.
- 9 The portion of the KDM that contains information about the recipient (target) certificate.
- 10 The serial number of the recipient certificate.
- 11 The Subject Name information from the recipient certificate.
- 12 The UUID of the CPL used to create the KDM.
- 13 The ContentTitleText from the CPL used to create the KDM.
- 14 The starting validity date of the KDM.
- 15 The ending validity date of the KDM.
- 16 Device list. This list contains the list of certificates thumbprints authorized for use with at least a portion of the KDM.
- 17 A certificate thumbprint in the device list.
- 18 The list of KeyIDs and their associated type.
- 19 The type of key represented by the KeyID.
- 20 The KeyID.
- 21 This flag determines whether forensic marking is enabled or disabled. The ForensicMarkFlagList may contain multiple instances of ForensicMarkFlag.

Example 3.6. KDM - AuthenticatedPublic area

```

<AuthenticatedPrivate Id="ID_AuthenticatedPrivate">❶
  <enc:EncryptedKey xmlns:enc="http://www.w3.org/2001/04/xmlenc#">❷
    <enc:EncryptionMethod
      Algorithm="http://www.w3.org/2001/04/xmlenc#rsa-oaep-mgf1p">❸
      <ds:DigestMethod
        xmlns:ds="http://www.w3.org/2000/09/xmldsig#"
        Algorithm="http://www.w3.org/2000/09/xmldsig#sha1" />
      </enc:EncryptionMethod>
      <enc:CipherData>
        <enc:CipherValue>❹
[256 Byte long encrypted cipherdata block omitted]
        </enc:CipherValue>
      </enc:CipherData>
    </enc:EncryptedKey>
    <enc:EncryptedKey xmlns:enc="http://www.w3.org/2001/04/xmlenc#"
      <enc:EncryptionMethod Algorithm="http://www.w3.org/2001/04/xmlenc#rsa-oaep-mgf1p">
        <ds:DigestMethod
          xmlns:ds="http://www.w3.org/2000/09/xmldsig#"
          Algorithm="http://www.w3.org/2000/09/xmldsig#sha1" />
        </enc:EncryptionMethod>
        <enc:CipherData>
          <enc:CipherValue>
[256 Byte long encrypted cipherdata block omitted]
          </enc:CipherValue>
        </enc:CipherData>
      </enc:EncryptedKey>
      <enc:EncryptedKey xmlns:enc="http://www.w3.org/2001/04/xmlenc#"
        <enc:EncryptionMethod Algorithm="http://www.w3.org/2001/04/xmlenc#rsa-oaep-mgf1p">
          <ds:DigestMethod
            xmlns:ds="http://www.w3.org/2000/09/xmldsig#"
            Algorithm="http://www.w3.org/2000/09/xmldsig#sha1" />
          </enc:EncryptionMethod>
          <enc:CipherData>
            <enc:CipherValue>
[ 256 Byte long encrypted cipherdata block omitted]
            </enc:CipherValue>
          </enc:CipherData>
        </enc:EncryptedKey>
        <enc:EncryptedKey xmlns:enc="http://www.w3.org/2001/04/xmlenc#"
          <enc:EncryptionMethod Algorithm="http://www.w3.org/2001/04/xmlenc#rsa-oaep-mgf1p">
            <ds:DigestMethod
              xmlns:ds="http://www.w3.org/2000/09/xmldsig#"
              Algorithm="http://www.w3.org/2000/09/xmldsig#sha1" />
            </enc:EncryptionMethod>
            <enc:CipherData>
              <enc:CipherValue>
[ 256 Byte long encrypted cipherdata block omitted]
              </enc:CipherValue>
            </enc:CipherData>
          </enc:EncryptedKey>
          [additional EncryptionKey entries omitted]
        </enc:EncryptedKey>
      </AuthenticatedPrivate>

```

- ❶ The start of the AuthenticatedPrivate section of the KDM
- ❷ The EncryptedKey element indicates there is data encrypted with an RSA public key algorithm.
- ❸ 3 The algorithm used to encrypt the data in the CipherData element.
- ❹ A 256 Byte long block of RSA encrypted data.

Example 3.7. KDM - AuthenticatedPrivate area

```

<dsig:Signature xmlns:dsig="http://www.w3.org/2000/09/xmldsig#"> ❶
<dsig:SignedInfo>
  <dsig:CanonicalizationMethod Algorithm="http://www.w3.org/TR/2001/REC-xml-c14n-20010315#WithComments" />
  <dsig:SignatureMethod Algorithm="http://www.w3.org/2001/04/xmldsig-more#rsa-sha256" /> ❷
  <dsig:Reference URI="#ID_AuthenticatedPublic"> ❸
    <dsig:DigestMethod Algorithm="http://www.w3.org/2001/04/xmenc#sha256" /> ❹
    <dsig:DigestValue>cnn8M41NR4jQF+9G0ZiNJTlfl+C/l8lBF1juCuq9lQE=</dsig:DigestValue> ❺
  </dsig:Reference>
  <dsig:Reference URI="#ID_AuthenticatedPrivate"> ❻
    <dsig:DigestMethod Algorithm="http://www.w3.org/2001/04/xmenc#sha256" />
    <dsig:DigestValue>TEW7tPwML2i0kIpK2/4rZbJbKgnnXjAtJwe90JSe8u4=</dsig:DigestValue>
  </dsig:Reference>
</dsig:SignedInfo>
<dsig:SignatureValue>uH41s9odRPXzFz+BF3dJ/myG09cLSE9cLzf2C7f2Fm49P9C53T5RSeEIYqt6p5ll ❻
z1H2q3ZJRZcZuV5VA7UkIb4z6U4CGUTU51D8LL/anY1glLFddjUiDU/0nmC4uAsH
rzwQgz0TzmZd2eLo0N70DBtNhTcJZftKUN202ybHZaJ7Q/aBxAiCK3h/fRW/b7zM
bcbsD9/VfJFI7VQC0LYwTxq643Exj7sYGKISRjuN+MLAubG50hu74YLOtA/dmGB1
G4VeXkBBR/BEj0EeoxyfFpXbZwkdoI18/Qd1JF32xpE1PLTLrJoRyjrX/6qkm90J
X9GyFNd8jVxdYNI4s1JCnQ==</dsig:SignatureValue>
<dsig:KeyInfo> ❹
  <dsig:X509Data>
    <dsig:X509IssuerSerial>
      <dsig:X509IssuerName>dnQualifier=wBz3yptkPxbHI/\+LUUeH5R6rQfI=,
CN=.cc-admin-x,OU=.cc-ra-la.s430-2.ca.example.com,O=.ca.example.com</dsig:X509IssuerName>
      <dsig:X509SerialNumber>6992</dsig:X509SerialNumber>
    </dsig:X509IssuerSerial>
    <dsig:X509Certificate> ❺
[PEM encoded certificate omitted]
</dsig:X509Certificate>
  </dsig:X509Data>
  <dsig:X509Data>
    <dsig:X509IssuerSerial>
      <dsig:X509IssuerName>dnQualifier=808W8oYHlf97Y8n0kdAgMU7/jUU=,
CN=.s430-2,OU=.ca.example.com,O=.ca.example.com</dsig:X509IssuerName>
      <dsig:X509SerialNumber>50966</dsig:X509SerialNumber>
    </dsig:X509IssuerSerial>
    <dsig:X509Certificate>
[PEM encoded certificate omitted]
</dsig:X509Certificate>
  </dsig:X509Data>
  <dsig:X509Data>
    <dsig:X509IssuerSerial>
      <dsig:X509IssuerName>dnQualifier=808W8oYHlf97Y8n0kdAgMU7/jUU=,
CN=.s430-2,OU=.ca.example.com,O=.ca.example.com</dsig:X509IssuerName>
      <dsig:X509SerialNumber>13278513546878383468</dsig:X509SerialNumber>
    </dsig:X509IssuerSerial>
    <dsig:X509Certificate>
[PEM encoded certificate omitted]
</dsig:X509Certificate>
  </dsig:X509Data>
</dsig:KeyInfo>
</dsig:Signature></DCinemaSecurityMessage>

```

- ❶ Start of the signature section of the KDM
- ❷ The canonicalization algorithm of the signature
- ❸ Specifies the signature algorithm (RSA) and the digest algorithm (SHA-256) of the signature.
- ❹ The AuthenticatedPublic reference element
- ❺ The method used to create the digest of the AuthenticatedPublic portion of the KDM
- ❻ The digest of the AuthenticatedPublic portion of the KDM
- ❼ The AuthenticatedPrivate reference element
- ❽ The RSA encrypted form of the two digests
- ❾ The section of the signature portion that contains the singer certificate and its certificate chain

10 The certificate used to sign the KDM

Example 3.8. KDM - Signature area

Since the KDM carries encrypted data, a tool that can decrypt the encrypted portions of the KDM has been provided in Section C.1. **kdm-decrypt** takes two arguments, a KDM and the RSA private key that corresponds to the certificate to which the KDM was targeted, and displays the contents of the encrypted section. Here is an example of **kdm-decrypt** and the resulting output:

```
$ kdm-decrypt <kdm-file>
<rsa-private-key.pem>
  CipherDataID: f1dc124460169a0e85bc300642f866ab 1
  SignerThumbprint: q50qr6GkfG6W2HzcBTee5m0Qjzw= 2
    CPL Id: 119d8990-2e55-4114-80a2-e53f3403118d 3
    Key Id: b6276c4b-b832-4984-aab6-250c9e4f9138 4
    Key Type: MDIK 5
  Not Before: 2007-09-20T03:24:53-00:00 6
  Not After: 2007-10-20T03:24:53-00:00 7
  Key Data: 7f2f711f1b4d44b83e1dd1bf90dc7d8c 8
```

- 1 The CipherData ID. This value is defined in [SMPTE-430-1]
- 2 Thumbprint of the certificate that signed the KDM
- 3 The UUID of the CPL associated with this KDM
- 4 The KeyID that corresponds to the key contained in this EncryptedKey cipherblock
- 5 The type of key contained in this EncryptedKey cipherblock
- 6 The beginning of validity period of the key
- 7 The end of validity period of the key
- 8 The encryption key

Example 3.9. kdm-decrypt Usage and Output

3.3. ETM Features

3.3.1. ETM Structure

Objective

Verify that the ETM portion of the KDM validates against the ETM schema in [SMPTE-430-3] .

Procedures

To verify that the ETM defined elements of the KDM are well formed, validate the KDM against the ETM schema in [SMPTE-430-3], use the procedure described in [Section 1.4](#), *i.e.*,

```
$ schema-check smpte-430-3.xsd <input-file>
schema validation successful
```

If the KDM is not valid or well formed, the program will report an error. A reported error is cause to fail this test.

Supporting Materials

Reference Documents	DCI-DCSS, 9.8 SMPTE-430-3
Test Equipment	schema-check Text Editor

3.3.2. ETM Validity Date Check

Objective

Verify that the signer's certificate chain was valid at the date specified in the <IssueDate> element in the <AuthenticatedPublic> area of the KDM.

Procedures

1. Extract each of the certificates in the signer's certificate chain from the KDM using a **Text Editor**, then, using the process described in [Section 2.1.16: Signature Validation](#), validate the certificate chain. Validation failure of the certificate chain is cause to fail this test.
2. Once the certificate chain has been successfully validated, view the signer certificate in text form using the openssl command as described in [Example 2.1](#). Locate the validity section of the certificate as indicated by **6** in the example certificate.
3. Using a **Text Editor**, view the contents of the KDM and locate the <IssueDate> element as shown in **7** of [Example 3.6](#).
4. Compare the Not Before and Not After values of the signer certificate to the date in the <IssueDate> element of the KDM and confirm that it is within the date range. An <IssueDate> value outside the date ranges of the certificate is cause to fail this test.

Supporting Materials

Reference Documents	DCI-DCSS, 9.8
Test Equipment	Text Editor openssl

3.3.3. ETM Signer Element

Objective

Verify that the certificate chain in the <Signer> element of the KDM is valid.

Procedures

1. Extract each of the certificates in the signer's certificate chain from the KDM using a **Text Editor** as described in [Section 1.4](#).
2. Using the process described in [Section 2.1.16: Signature Validation](#), validate the certificate chain. Validation failure of the certificate chain is cause to fail this test.

Supporting Materials

Reference Documents	DCI-DCSS, 9.8 SMPTE-430-1
----------------------------	------------------------------

Test Equipment	SMPTE-430-2 Text Editor openssl
-----------------------	--

3.3.4. ETM EncryptionMethod Element

Objective

Verify that the Algorithm attribute of the <EncryptionMethod> for the encrypted key has the value "http://www.w3.org/2001/04/xmlenc#rsaoaep-mgf1p".

Procedures

Using a **Text Editor**, view the KDM and confirm that the Algorithm attribute of the <EncryptionMethod> element in the <AuthenticatedPrivate> element for each of the encrypted keys, as indicated by **3** in the example KDM, is "http://www.w3.org/2001/04/xmlenc#rsaoaep-mgf1p". Any other value in this attribute is cause to fail this test.

Supporting Materials

Reference Documents	DCI-DCSS, 9.8 SMPTE-430-1
Test Equipment	Text Editor

3.3.5. ETM AnnotationText Language

Objective

Verify that the content of the <AnnotationText> element is in a human-readable language. If the optional xml:lang attribute is present, the language must match. If the xml:lang attribute is not present, the language must be English.

Procedures

Using a **Text Editor**, view the KDM and confirm that the <AnnotationText> element as indicated by **6** in the [Example 3.6](#) is a human-readable language. The presence of non-human-readable data or text in a language other than English without that language's corresponding xml:lang value is cause to fail this test.

Supporting Materials

Reference Documents	SMPTE-430-1
Test Equipment	Text Editor

3.3.6. ETM ReferenceList Element

Objective

Verify that the <ReferenceList> element of the <EncryptedKey> element is not present.

Procedures

Using a **Text Editor**, view the KDM and confirm that, for each instance of the <EncryptedKey> element, the <ReferenceList> element is not present. The presence of the <ReferenceList> element indicates that the KDM is malformed and is cause to fail this test.

Supporting Materials

Reference Documents	SMPTE-430-1
Test Equipment	Text Editor

3.3.7. ETM SignedInfo CanonicalizationMethod Element

Objective

Verify that the value of the Algorithm attribute of the <CanonicalizationMethod> element of the <SignedInfo> element in the <Signature> area of the KDM is "http://www.w3.org/TR/2001/REC-xml-c14n-20010315#WithComments".

Procedures

Using a **Text Editor**, view the KDM and confirm that the value of the Algorithm attribute of the <CanonicalizationMethod> of the <SignedInfo> element of the <Signature> element is "http://www.w3.org/TR/2001/REC-xml-c14n-20010315#WithComments", as shown in **2** of [Example 3.8](#). Any other value in this attribute is cause to fail this test.

Supporting Materials

Reference Documents	SMPTE-430-1
Test Equipment	Text Editor

3.3.8. ETM Signature Reference Elements

Objective

Verify that the <SignedInfo> element of the <Signature> area of the KDM contains at least two child <Reference> elements. The value of the URI attribute of each <Reference> element must correspond to the respective ID attribute of the digested element. Verify that the URI attribute of one of the <Reference> element identifies the AuthenticatedPublic portion of the KDM. Verify that the URI attribute of one of the <Reference>; element identifies the AuthenticatedPrivate portion of the KDM.

Procedures

1. Using a **Text Editor**, view the KDM and confirm that the <SignedInfo> element of the <Signature> area of the KDM has at least two child <Reference> elements as shown in **4** and **7** of [Example 3.8](#). The presence of fewer than two <Reference> elements is cause to fail this test.
2. Confirm that the URI attribute of one of the <Reference> element matches the value of the ID attribute of the AuthenticatedPublic element, as shown by **4** in [Example 3.8](#) and **3** in [Example 3.6](#). The absence of this association in the KDM is cause to fail this test.

3. Confirm that the URI attribute of one of the <Reference> element matches the value of the ID attribute of the AuthenticatedPrivate element, as shown by **7** in [Example 3.8](#) and **1** in [Example 3.7](#). The absence of this association in the KDM is cause to fail this test.

Supporting Materials

Reference Documents	SMPTE-430-1
Test Equipment	Text Editor

3.3.9. ETM SignatureMethod Element

Objective

Verify that the <SignatureMethod> element of the <SignedInfo> element of the <Signature> area of the KDM contains the URI value "http://www.w3.org/2001/04/xmldsig-more#rsa-sha256".

Procedures

Using a **Text Editor**, view the KDM and confirm that the <SignatureMethod> element of the <SignedInfo> element of the <Signature> section of the KDM contains the URI value "http://www.w3.org/2001/04/xmldsig-more#rsa-sha256", as shown in **8** of [Example 3.8](#). Any other value is cause to fail this test.

Supporting Materials

Reference Documents	SMPTE-430-1
Test Equipment	Text Editor

3.3.10. ETM Signature Transforms Field

Objective

Verify that <Reference> elements of the <SignedInfo> element in the <Signature> section of the KDM do not contain a Transforms attribute.

Procedures

Using a **Text Editor**, view the KDM and confirm that the <Reference> elements of the <SignedInfo> element in the <Signature> section of the KDM do not contain a Transforms attribute. The presence of the Transforms attribute is cause to fail this test.

Supporting Materials

Reference Documents	SMPTE-430-1 SMPTE-430-3
Test Equipment	Text Editor

3.3.11. ETM Signature DigestMethod Element

Objective

Verify that the value of the `Algorithm` attribute of the `<DigestMethod>` element of each of the `<Reference>` elements in the `<SignedInfo>` element of the `<Signature>` section of the KDM is " `http://www.w3.org/2001/04/xmldsig#sha256`".

Procedures

Using a **Text Editor**, view the KDM and confirm that the value of the `Algorithm` attribute of the `<DigestMethod>` element of each of the `<Reference>` elements is "`http://www.w3.org/2001/04/xmldsig#sha256`", as shown in **5** of [Example 3.8](#). Any other value is cause to fail this test.

Supporting Materials

Reference Documents	SMPTE-430-3
Test Equipment	Text Editor

3.3.12. ETM Signature Validity

Objective

Verify that the signature is properly formed, *i.e.*, the `<Signature>` element is properly encoded, all digests are properly formed, the `<SignatureMethod>` and `<CanonicalizationMethod>` in the `<SignedInfo>` element are correct, and the `<Reference>` values are correct. Verify that the signature is valid.

Procedures

Verifying that the signature is well formed (the XML structure is correct) and that the signature is valid (is properly encoded) can be done by verifying the signature XML against the schema using a validating XML parser, then validating the signature.

1. Using the schema validating tool **schema-check**, validate the KDM against the schema found in [SMPTE-430-3] as described in [Section 1.4](#), *i.e.*,

```
$ schema-check <input-file> smpte-430-3.xsd  
schema validation successful
```

If the KDM is not valid or well formed, the program will report an error. A reported error is reason to fail this test.

2. Using the **checksig** program, verify that there is a signature included in the KDM and that it is valid. A missing or invalid signature is cause to fail this test. Note: Depending on the order of the certificates contained in the log report, the **dsig_cert.py** program may need to be used to re-order the certificates for the **checksig** program.

Supporting Materials

Reference Documents	SMPTE-430-3
Test Equipment	Text Editor schema-check

checksig dsig_cert.py
--

3.4. KDM Features

3.4.1. KDM MessageType Element

Objective

Verify that the <MessageType> element of the KDM contains the string "http://www.smpte-ra.org/430-1/2006/KDM#kdm-key-type"

Procedures

Using a **Text Editor**, view the KDM and confirm that the <MessageType> element of the KDM contains the string "http://www.smpte-ra.org/430-1/2006/KDM#kdm-key-type" as shown in **5** of [Example 3.6](#). Any other value in this element is cause to fail this test.

Supporting Materials

Reference Documents	DCI-DCSS, 9.8 SMPTE-430-1
Test Equipment	Text Editor

3.4.2. KDM SubjectName Element

Objective

Verify that the Subject Name of the recipient X.509 certificate (target certificate) is identical to the value of the <SubjectName> element of the <Recipient> element of the <KDMRequiredExtensions> element in the KDM.

Procedures

Comparison of the Subject Name of the certificate against the content of the SubjectName element can be achieved by viewing the text version of the certificate and comparing it to the KDM element to verify they are the same.

1. Using the method described in [Example 2.1](#), view the text information of the certificate and identify the X.509 subject name as shown in **9** .
2. Using a **Text Editor**, view the contents of the KDM and identify the <SubjectName> of the <Recipient> element as shown in **11** .
3. Confirm that the value of the <SubjectName>element is the same as the Subject Name of the certificate. Differing values are cause to fail this test.

Supporting Materials

Reference Documents	DCI-DCSS, 9.8 SMPTE-430-1
----------------------------	------------------------------

Test Equipment	SMPTE-430-2 Text Editor openssl
-----------------------	---

3.4.3. KDM ContentAuthenticator Element

Objective

Verify that, when present, the <ContentAuthenticator> element of the <KDMRequiredExtensions> element of the KDM contains one of the certificate thumbprints of one of the certificates in the chain of the signer of the CPL.

Procedures

If the element exists in the KDM:

1. Using **Text Editor**, view value of the <ContentAuthenticator> element of the <KDMRequiredExtensions> element of the KDM. If the element is not present, this test is considered passed and the remaining procedure steps are not performed.
2. Extract the certificates from the CPL signature. Note: This may be accomplished using the **dsig_extract.py** program.
3. Using **dc-thumbprint**, calculate the thumbprint each of the certificates:

```
$ dc-thumbprint <certificate.pem>
```

4. Confirm that the <ContentAuthenticator> value matches one of the thumbprints of the certificate chain of the signer certificate.

Presence of the <ContentAuthenticator> with a value that does not match one of the thumbprints is cause to fail this test.

Supporting Materials

Reference Documents	DCI-DCSS, 9.8 SMPTE-429-7 SMPTE-430-1
Test Equipment	dc-thumbprint Text Editor

3.4.4. KDM Signer Certificate Presence

Objective

Verify that the certificate that signed the KDM is present in one of the <X509Data> elements of the <KeyInfo> elements in the signature portion of the KDM.

Procedures

Testing that the certificate that signed the KDM is present in an <X509Data> element can be achieved by validating the signature. If the validation is successful then the certificate that signed the KDM is present. The signature can be validated using the **dsig_cert.py** and **checksig** commands:

Example:

```
$ dsig_cert.py <kdm-file.kdm.xml> > tmp.xml
$ checksig tmp.xml
```

A KDM that causes **checksig** to display errors indicates that the signature did not validate and shall be cause to fail this test.

Supporting Materials

Reference Documents	SMPTE-430-1
Test Equipment	Text Editor checksig dsig_cert.py

3.4.5. KDM KeyIdList/TypedKeyId Field

Objective

Verify that <TypedKeyId> element of the <KeyIdList> element in the <KDMRequiredExtensions> element is well formed. Verify that the element contains one of the following values: MDIK, MDAK, MDSK, FMIK, or FMAK.

Procedures

To complete this test, validate the KDM against the schema in [SMPTE-430-1], then verify that one of the required values is present in the element.

1. Validate the KDM against the schema in [SMPTE-430-1] using the procedure described in [Section 1.4](#), *i.e.*,

```
$ schema-check <kdm-file.kdm.xml> smpte-430-1.xsd
schema validation successful
```

If the KDM is not valid or well formed, the program will report an error. A reported error is cause to fail this test.

2. Using a **Text Editor**, view the value of the <TypedKeyId> element, and verify that the element contains one of: MDIK, MDAK, MDSK, FMIK, or FMAK, as shown in [19](#) of [Example 3.6](#) Any other value in this element is cause to fail this test.

Supporting Materials

Reference Documents	DCI-DCSS, 9.8 SMPTE-430-1
Test Equipment	Text Editor schema-check

3.4.6. KDM ForensicMarkFlagList Element

Objective

Verify that, if present, the <ForensicMarkFlagList> element contains a list of one or both of the following two URIs:

- <http://www.smpte-ra.org/430-1/2006/KDM#mrkflg-picture-disable>
- <http://www.smpte-ra.org/430-1/2006/KDM#mrkflg-audio-disable>

Procedures

Using a **Text Editor**, view the KDM and confirm the presence of the <ForensicMarkFlagList> element. The absence of the element is cause to pass this test and the remainder of this procedure can be skipped. If present, the element must contain one or both of the following URI values:

- <http://www.smpte-ra.org/430-1/2006/KDM#mrkflg-picture-disable>
- <http://www.smpte-ra.org/430-1/2006/KDM#mrkflg-audio-disable>

as shown by **21** of [Example 3.6](#) The presence of the element with any other value, or no value, is cause to fail this test.

Supporting Materials

Reference Documents	SMPTE-430-1
Test Equipment	Text Editor

3.4.7. KDM EncryptedData Element

Objective

Verify that element <EncryptedData> is not present.

Procedures

Using a **Text Editor**, view the KDM and confirm that the <EncryptedData> element is not present. The presence of the element is cause to fail this test.

Supporting Materials

Reference Documents	DCI-DCSS, 9.8 SMPTE-430-1
Test Equipment	Text Editor

3.4.8. KDM KeyInfo Element

Objective

If present, verify that the values of each <KeyInfo> element of all <EncryptedKey> elements in the <AuthenticatedPrivate> section of the KDM are identical.

Procedures

Using a **Text Editor**, view the KDM and, if present, confirm that the <KeyInfo> values are identical in all instances of <EncryptedKey> elements. The absence of <KeyInfo> elements is cause to pass this test. The presence of differing <KeyInfo> values in <EncryptedKey> elements is cause to fail this test.

Supporting Materials

Reference Documents	DCI-DCSS, 9.8 SMPTE-430-1
Test Equipment	Text Editor

3.4.9. KDM DeviceListDescription Element

Objective

Verify that when present, the value of the <DeviceListDescription> element is in a human-readable language. If the optional `xml:lang` attribute is present, the language must match. If the `xml:lang` attribute is not present, the language must be English.

Procedures

See Objective.

Using a **Text Editor**, view the KDM and confirm that the <DeviceListDescription> element is either absent or is present and contains human-readable text. The presence of non-human-readable data or text in a language other than English without that language's corresponding `xml:lang` value is cause to fail this test.

Supporting Materials

Reference Documents	DCI-DCSS, 9.8 SMPTE-430-1
Test Equipment	Text Editor

3.4.10. KDM ContentTitleText Language Attribute

Objective

Verify that value of the <ContentTitleText> element is in a human-readable language. If the optional `xml:lang` attribute is present, the language must match. If the `xml:lang` attribute is not present, the language must be English.

Procedures

Using a **Text Editor**, view the KDM and confirm that the <ContentTitleText> element as indicated by **13** in the [Example 3.6](#) is a human-readable language. The presence of non-human-readable data or text in a language other than English without that language's corresponding `xml:lang` value is cause to fail this test.

Supporting Materials

Reference Documents	SMPTE-430-1
Test Equipment	Text Editor

3.4.11. KDM KeyType Scope Attribute

Objective

Verify that the optional scope attribute of the <TypedKeyId> element of the <KeyIdList> element is absent or contains the value `http://www.smpte-ra.org/430-1/2006/KDM#kdm-key-type`.

Procedures

Using a **Text Editor**, view the KDM and confirm that the scope attribute of the <TypedKeyId> element is either not present or is present and contains the value `http://www.smpte-ra.org/430-1/2006/KDM#kdm-key-type`, as shown in **19** of [Example 3.6](#). Presence of the scope attribute with any other value is cause to fail this test.

Supporting Materials

Reference Documents	SMPTE-430-1 SMPTE-430-3
Test Equipment	Text Editor

3.4.12. KDM EncryptionMethod

Objective

Verify that the Algorithm attribute of the <EncryptionMethod> element of the <EncryptedKey/> element has the value `"http://www.w3.org/2001/04/xmlenc#rsa-oaep-mgf1p"`.

Procedures

Using a **Text Editor**, view the KDM and confirm that the Algorithm attribute of the <EncryptionMethod> of the <EncryptedKey/> element contains the value `http://www.w3.org/2001/04/xmlenc#rsa-oaepmgf1p`, as shown in **3** of [Example 3.7](#). Presence of the Algorithm attribute with any other value is cause to fail this test.

Supporting Materials

Reference Documents	SMPTE-430-1 SMPTE-430-3
Test Equipment	Text Editor openssl

3.4.13. KDM CompositionPlaylistId Element

Objective

Verify that the value of the <CompositionPlaylistId> element in the KDM matches the value in the RSA protected <EncryptedKey> structure, and that these values match the value of the <Id> element in the respective composition playlist.

Procedures

The data in the encrypted portion of the KDM can be viewed using the **kdm-decrypt** tool included in [Section C.1](#). To view the data contained in the encrypted section of the KDM, run the command specifying the KDM and the RSA private key corresponding to the certificate to which the KDM was targeted, *i.e.*,

```
$ kdm-decrypt <kdm-file> <rsa-private-key.pem>
```

Verify that the <CompositionPlaylistId> element of the <KDMRequiredExtensions> element in the plaintext portion of the KDM contains the same value as the CPL ID present in the RSA protected <EncryptedKey> structure. Non-identical values shall be cause to fail this test.

Supporting Materials

Reference Documents	DCI-DCSS, 9.8 SMPTE-429-7 SMPTE-430-1
Test Equipment	Text Editor kdm-decrypt

3.4.14. KDM Validity Fields

Objective

Verify that value of the <ContentKeysNotValidBefore> and <ContentKeysNotValidAfter> elements match their counterparts in the RSA protected <EncryptedKey> structure and that the values are in UTC format.

Procedures

The information in the encrypted portion of the KDM can be viewed using the **kdm-decrypt** tool included in [Section C.1](#). To view the data contained in the encrypted section of the KDM, run the command specifying the KDM and the RSA private key corresponding to the certificate to which the KDM was targeted, *i.e.*,

```
$ kdm-decrypt <kdm-file> <rsa-private-key.pem>
```

Verify that the <ContentKeysNotValidBefore> element of the <KDMRequiredExtensions> element has the same value as the corresponding field inside the RSA protected EncryptedKey structure, and that it is in UTC format as specified in [RFC-3339]. Non-identical values shall be cause to fail this test.

Verify that the <ContentKeysNotValidAfter> element of the <KDMRequiredExtensions> element has the same value as the corresponding field inside the RSA protected EncryptedKey structure, and that it is in UTC format as specified in [RFC-3339]. Non-identical values shall be cause to fail this test.

Supporting Materials

Reference Documents	DCI-DCSS, 9.8 RFC-3339 SMPTE-430-1
Test Equipment	Text Editor

3.4.15. KDM KeyIDList Element

Objective

Verify that each of the KeyID values in the <KeyIDList> element of the <KDMRequiredExtensions> element matches a KeyID in the RSA protected <EncryptedKey> structure and that there are no KeyIDs without corresponding <EncryptedKey> structures, nor <EncryptedKey> structures with KeyIDs that are not present in the KeyIDList.

Procedures

The data in the encrypted portion of the KDM can be viewed using the **kdm-decrypt** tool included in [Section C.1](#). To view the data contained in the encrypted section of the KDM, run the command specifying the KDM and the RSA private key corresponding to the certificate to which the KDM was targeted, *i.e.*,

```
$ kdm-decrypt <kdm-file> <rsa-private-key.pem>
```

Compare the list of KeyIDs to the KeyIDs in the RSA protected EncryptedKey structures and verify that each of the KeyIDs in the list correspond to a KeyID in an RSA protected EncryptedKey structure. The presence of KeyIDs in the KeyIDList that do not correspond to a KeyID in an RSA protected EncryptedKey structure shall be cause to fail this test. The presence of a KeyID in an RSA protected EncryptedKey structure that is not also present in the KeyIDList shall be cause to fail this test.

Supporting Materials

Reference Documents	DCI-DCSS, 9.8 SMPTE-430-1
Test Equipment	kdm-decrypt Text Editor

3.4.16. KDM CipherData Structure ID

Objective

Verify that the value of the CipherData Structure ID in the RSA protected <EncryptedKey> structure is f1dc124460169a0e85bc300642f866ab.

Procedures

The data in the encrypted portion of the KDM can be viewed using the **kdm-decrypt** tool included in [Section C.1](#). To view the data contained in the encrypted section of the KDM, run the command specifying the KDM and the RSA private key corresponding to the certificate to which the KDM was targeted, *i.e.*,

```
$ kdm-decrypt <kdm-file> <rsa-private-key.pem>
```

Verify that the plaintext value of the CipherData Structure ID is f1dc124460169a0e85bc300642f866ab. Any other value shall be cause to fail this test.

Supporting Materials

Reference Documents	DCI-DCSS, 9.8 SMPTE-430-1
Test Equipment	kdm-decrypt

3.4.17. KDM CipherData Signer Thumbprint

Objective

Verify that the thumbprint of the signer's certificate in the RSA protected <EncryptedKey> element matches the thumbprint of the certificate that signed the KDM.

Procedures

The data in the encrypted portion of the KDM can be viewed using the **kdm-decrypt** tool included in [Section C.1](#). To view the data contained in the encrypted section of the KDM, run the command specifying the KDM and the RSA private key corresponding to the certificate to which the KDM was targeted, *i.e.*,

```
$ kdm-decrypt <kdm-file> <rsa-private-key.pem>
```

A certificate thumbprint can be calculated using the **dc-thumbprint** tool included in [Section C.1](#). Calculate the thumbprint with **dc-thumbprint**, *i.e.*,

```
$dc-thumbprint <certificate.pem>
```

Identify the certificate used to sign the KDM and calculate its thumbprint. Compare this thumbprint against the thumbprint decrypted from the <EncryptedKey> element and confirm that they are the same. Non-identical values shall be cause to fail this test.

Supporting Materials

Reference Documents	DCI-DCSS, 9.8 SMPTE-430-1 SMPTE-430-2
Test Equipment	dc-thumbprint kdm-decrypt Text Editor

3.4.18. KDM CipherData Validity

Objective

Verify that the two CipherData validity fields contain UTC format time values.

Procedures

The data in the encrypted portion of the KDM can be viewed using the **kdm-decrypt** tool included in [Section C.1](#). To view the data contained in the encrypted section of the KDM, run the command specifying the KDM and the RSA private key corresponding to the certificate to which the KDM was targeted, *i.e.*,

```
$ kdm-decrypt <kdm-file> <rsa-private-key.pem>
```

Verify that the plaintext representation of the <EncryptedKey> element contains two validity time stamps in UTC format. Time stamps that are not present or that are not in UTC format shall be cause to fail this test.

Supporting Materials

Reference Documents	DCI-DCSS, 9.8 SMPTE-430-1
Test Equipment	Text Editor kdm-decrypt

3.4.19. KDM CipherData CPL ID

Objective

Verify that the CipherData Composition Playlist ID is identical to the value of the <CompositionPlaylistId> element in the other portions of the KDM.

Procedures

The data in the encrypted portion of the KDM can be viewed using the **kdm-decrypt** tool included in [Section C.1](#). To view the data contained in the encrypted section of the KDM, run the command specifying the KDM and the RSA private key corresponding to the certificate to which the KDM was targeted, *i.e.*,

```
$ kdm-decrypt <kdm-file> <rsa-private-key.pem>
```

Verify that the decrypted plaintext value of the CompositionPlaylistID the same as the <CompositionPlaylistId> element in the AuthenticatedPublic area of the KDM. Mismatching composition playlist IDs shall be cause to fail this test.

Supporting Materials

Reference Documents	DCI-DCSS, 9.8 SMPTE-430-1
Test Equipment	Text Editor openssl

3.4.20. KDM EncryptedKey KeyType

Objective

Verify that the key types in the <EncryptedKey> elements of the KDM use only the allowed key types (MDIK, MDAK, MDSK, FMIK and FMAK), and that they match the plaintext fields in the <TypedKeyId> element values for the KeyIDs in the <KeyIdList> element.

Procedures

The data in the encrypted portion of the KDM can be viewed using the **kdm-decrypt** tool included in [Section C.1](#). To view the data contained in the encrypted section of the KDM, run the command specifying the KDM and the RSA private key corresponding to the certificate to which the KDM was targeted, *i.e.*,

```
$ kdm-decrypt <kdm-file> <rsa-private-key.pem>
```

For each <EncryptedKey> element, verify that the plaintext representation contains a key type that is one of MDIK, MDAK, MDSK, FMIK or FMAK, and that the key type is identical to the key type for the corresponding KeyID in the KeyIDList. A key type that is not either MDIK, MDAK, MDSK, FMIK or FMAK shall be cause to fail this test. A key type in the <EncryptedKey> element that does not match the key type for the corresponding KeyID in the KeyIDList shall be cause to fail this test.

Supporting Materials

Reference Documents	SMPTE-430-1
Test Equipment	Text Editor kdm-decrypt

3.4.21. KDM Recipient X509IssuerName

Objective

Verify that the Distinguished Name value in the <X509IssuerName> element is compliant with [RFC-2253].

Procedures

Using a **Text Editor**, view the KDM and confirm that the <X509IssuerName> element as shown below **8** of [Example 3.6](#). Verify that any special characters are properly escaped, and the sequence is correct and valid. Improperly escaped characters or sequences that do not conform to [RFC-2253] shall be cause to fail this test.

Supporting Materials

Reference Documents	RFC-2253 SMPTE-430-1
Test Equipment	Text Editor

3.5. KDM Decoder Behavior

The procedures in this section test the behavior of a KDM decoding device, such as a Security Manager (SM) or a KDM authoring device. The procedures use a generic syntax to instruct the test operator to cause the Test Subject to decode a KDM.

In the case of an SM, the text "Perform an operation..." should be interpreted to mean "Assemble and play a show with *DCI 2K StEM (Encrypted)*...".

In the case of a KDM authoring device, the text "Perform an operation..." should be interpreted to mean "Perform a KDM read or ingest operation...".

Note:

Some of the procedures in this section require test content that is specifically malformed. In some implementations, these malformations may be caught and reported directly by the SMS without involving the SM. Because the purpose of the procedures is to assure that the SM demonstrates the required behavior, the manufacturer of the Test Subject may need to

provide special test programs or special SMS testing modes to allow the malformed content to be applied directly to the SM.

3.5.1. KDM NonCriticalExtensions Element

Objective

Verify that a decoding device does not reject a KDM when the <NonCriticalExtensions> element is present and not empty.

Procedures

Perform an operation on the Test Subject using *KDM with non-empty NonCriticalExtensions*, a KDM that contains the <NonCriticalExtensions> element with child content. Verify that the operation is successful. A failed operation shall be cause to fail this test.

Supporting Materials

Reference Documents	DCI-DCSS, 9.8, 9.4.3.5 SMPTE-430-1 SMPTE-430-3
Test Materials	<i>KDM with non-empty NonCriticalExtensions</i> <i>DCI 2K StEM (Encrypted)</i>

Consolidated Test Sequences

Sequence	Type	Measured Data
15.2. Integrated IMB Test Sequence	Pass/Fail	—
21.2. Integrated IMBO Test Sequence	Pass/Fail	—

3.5.2. ETM IssueDate Field Check

Objective

- Verify that the Test Subject verifies that the signer's certificate is valid at the time when the KDM was issued.
- Verify that the Test Subject verifies that the KDM validity does not extend beyond the ending validity period of the certificate.

Procedures

For each of the malformations below, perform an operation on the Test Subject using the test material that has that malformation. Verify that the operation fails. A successful operation is cause to fail this test.

1. KDM in which the certificate that signed the KDM has an ending validity date prior to the KDM issue date (*KDM with expired Signer certificate*).
2. KDM in which the certificate that signed the KDM has a starting validity date after the KDM issue date (*KDM issued before certificate valid*).

3. KDM in which the validity period extends beyond the end of the signing certificate's validity period (*KDM validity exceeds signer validity*).

Supporting Materials

Reference Documents	DCI-DCSS, 9.8, 9.4.3.5 SMPTE-430-1 SMPTE-430-3
Test Materials	<i>KDM with expired Signer certificate</i> <i>KDM issued before certificate valid</i> <i>KDM validity exceeds signer validity</i> <i>DCI 2K StEM (Encrypted)</i>

Consolidated Test Sequences

Sequence	Type	Measured Data
15.2. Integrated IMB Test Sequence	Pass/Fail	—
21.2. Integrated IMBO Test Sequence	Pass/Fail	—

3.5.3. Deleted Section

The section "Maximum Number of DCP Keys" was deleted. The section number is maintained here to preserve the numbering of subsequent sections.

3.5.4. Structure ID Check

Objective

Verify that the Test Subject checks the validity of the CipherData Structure ID as specified in [SMPTE-430-1] and rejects the KDM if the Structure ID is incorrect.

Procedures

Perform an operation on the Test Subject using *KDM with corrupted CipherData block*, a KDM with an invalid CipherData Structure. Verify that the operation fails. A successful operation is cause to fail this test.

Supporting Materials

Reference Documents	DCI-DCSS, 9.8, 9.4.3.5 SMPTE-430-1 SMPTE-430-3
Test Materials	<i>KDM with corrupted CipherData block</i> <i>DCI 2K StEM (Encrypted)</i>

Consolidated Test Sequences

Sequence	Type	Measured Data
----------	------	---------------

15.2. Integrated IMB Test Sequence	Pass/Fail	—
21.2. Integrated IMBO Test Sequence	Pass/Fail	—

3.5.5. Certificate Thumbprint Check

Objective

Verify that the Test Subject checks that the thumbprint of the signer's certificate matches the signer of the KDM and rejects the KDM if it does not.

Procedures

Perform an operation on the Test Subject using the KDM with a signer's certificate whose thumbprint does not match the thumbprint of the certificate used to sign the KDM (*KDM with incorrect signer thumbprint*). Verify that the operation fails. A successful operation is cause to fail this test.

Supporting Materials

Reference Documents	DCI-DCSS, 9.8, 9.4.3.5 SMPTE-430-1 SMPTE-430-3
Test Materials	<i>KDM with incorrect signer thumbprint</i> <i>DCI 2K StEM (Encrypted)</i>

Consolidated Test Sequences

Sequence	Type	Measured Data
15.2. Integrated IMB Test Sequence	Pass/Fail	—
21.2. Integrated IMBO Test Sequence	Pass/Fail	—

3.5.6. Deleted Section

The section "Certificate Presence Check" was deleted. The section number is maintained here to preserve the numbering of subsequent sections.

3.5.7. KeyInfo Field Check

Objective

Verify that when KeyInfo elements are present in the <EncryptedKey> elements of the <AuthenticatedPrivate> area of the KDM, the Test Subject verifies that they all match, and that the Test Subject rejects the KDM if they do not match.

Procedures

Perform an operation on the Test Subject using the KDM with KeyInfo element values that do not match (*KDM with KeyInfo mismatch*). Verify that the operation fails. A successful operation is cause to fail this test.

Supporting Materials

Reference Documents	DCI-DCSS, 9.8, 9.4.3.5
----------------------------	------------------------

Test Materials	SMPTE-430-1
	SMPTE-430-3
	<i>KDM with KeyInfo mismatch</i>
	<i>DCI 2K StEM (Encrypted)</i>

Consolidated Test Sequences

Sequence	Type	Measured Data
15.2. Integrated IMB Test Sequence	Pass/Fail	—
21.2. Integrated IMBO Test Sequence	Pass/Fail	—

3.5.8. KDM Malformations

Objective

Verify that the SM checks that the KDM is well formed and labeled with the correct namespace name.

Procedures

1. Perform an operation on the Test Subject using *KDM with invalid XML*, which contains XML that is not well-formed. If the operation succeeds this is cause to fail this test.
2. Perform an operation on the Test Subject using *KDM with invalid MessageType*, which contains an incorrect ETM <MessageType> value. If the operation succeeds this is cause to fail this test.
3. Perform an operation on the Test Subject using *KDM with expired Signer certificate*, which contains a KDM whose signing certificate has expired. If the operation succeeds this is cause to fail this test.
4. Perform an operation on the Test Subject using *KDM with incorrect namespace name value*, which contains an incorrect ETM namespace name. If the operation succeeds this is cause to fail this test.
5. Perform an operation on the Test Subject using *KDM with empty TDL*, which contains a TDL with no entries. If the operation succeeds this is cause to fail this test.
6. Extract a security log from the Test Subject and using a **Text Editor**, identify the KDMKeysReceived events associated with the above steps and:
 - a. Confirm that all required elements have correctly formatted parameters as defined in [SMPTE-430-5]. Missing required elements or incorrect parameters shall be cause to fail this test.
 - b. For the log record produced by the operation using *KDM with invalid MessageType*, verify that the value of the SignerID parameter contains the Certificate Thumbprint of the signing certificate of *KDM with invalid MessageType*. Verify that ReferencedIDs element contains a KeyDeliveryMessageID parameter with a value that is the MessageId of *KDM with invalid MessageType*. Failure of any verification shall be cause to fail this test.
 - c. For the log record produced by the operation using *KDM with expired Signer certificate*, verify that the contentId element contains the Id of *DCI 2K StEM (Encrypted)*. Verify that the value of the SignerID

parameter contains the Certificate Thumbprint of the signing certificate of *KDM with expired Signer certificate*. Verify that ReferencedIDs element contains a CompositionID parameter with a value that is the Id of *DCI 2K StEM (Encrypted)* and KeyDeliveryMessageID parameter with a value that is the MessageId of *KDM with expired Signer certificate*. Failure of any verification shall be cause to fail this test.

- d. Confirm the presence of a KDMFormatError exception in each KDMKeysReceived log record. Record any additional parameters associated with the exception. A missing KDMFormatError exception in any of the associated KDMKeysReceivedlog records shall be cause to fail this test.

Supporting Materials

Reference Documents	DCI-DCSS, 9.4.6.3.8, 9.8, 9.4.3.5 SMPTE-430-1 SMPTE-430-3 SMPTE-430-5
Test Materials	<i>KDM with empty TDL</i> <i>KDM with expired Signer certificate</i> <i>KDM with invalid XML</i> <i>KDM with invalid MessageType</i> <i>KDM with incorrect namespace name value</i> <i>DCI 2K StEM (Encrypted)</i>

Consolidated Test Sequences

Sequence	Type	Measured Data
15.2. Integrated IMB Test Sequence	Pass/Fail	—
21.2. Integrated IMBO Test Sequence	Pass/Fail	—

3.5.9. KDM Signature

Objective

Verify that the Test Subject checks that the KDM signature is valid, including checking that the certificate that signed the KDM is included in the KDM and rejecting the KDM if it is not.

Procedures

1. Perform an operation on the Test Subject using *KDM with incorrect message digest*. The KDM *KDM with incorrect message digest* is invalid (wrong signature/hash error). If the operation succeeds this is cause to fail this test.
2. Perform an operation on the Test Subject using *KDM with incorrect signer thumbprint*. The KDM *KDM with incorrect signer thumbprint* is invalid (wrong signature identity). If the operation succeeds this is cause to fail this test.
3. Perform an operation on the Test Subject using *KDM without signer certificate*. The KDM *KDM without signer certificate* is invalid (broken certificate chain). If the operation succeeds this is cause to fail this test.

4. Extract a security log from the Test Subject and using a **Text Editor**, identify the `KDMKeysReceived` events associated with the above steps and:
 - a. Confirm that all required elements have correctly formatted parameters as defined in [SMPTE-430-5]. Verify that the `contentId` element contains the Id of *DCI 2K StEM (Encrypted)*. Verify that `ReferencedIDs` element contains a `CompositionID` parameter with a value that is the Id of *DCI 2K StEM (Encrypted)* and `KeyDeliveryMessageID` parameter with a value that is the `MessageId` of the KDM used. Missing required elements or incorrect parameters shall be cause to fail this test.
 - b. For the log records produced by the operation using *KDM with incorrect message digest* and *KDM with incorrect signer thumbprint*, verify that the value of the `SignerId` parameter contains the Certificate Thumbprint of the signing certificate of the KDM.
 - c. Confirm the presence of a `SignatureError` exception in each `KDMKeysReceived` log record. Record any additional parameters associated with the exception. A missing `SignatureError` exception in any of the associated `KDMKeysReceived` log records shall be cause to fail this test.
5. Perform an operation on the Test Subject using *KDM signed with incorrect signer certificate format*. The KDM *KDM signed with incorrect signer certificate format* is invalid (wrong signer certificate format). If the operation succeeds this is cause to fail this test.
6. Extract a security log from the Test Subject and using a **Text Editor**, identify the `KDMKeysReceived` event associated with the above step and:
 - a. Confirm that all required elements have correctly formatted parameters as defined in [SMPTE-430-5]. Verify that the `contentId` element contains the Id of *DCI 2K StEM (Encrypted)*. Verify that `ReferencedIDs` element contains a `CompositionID` parameter with a value that is the Id of *DCI 2K StEM (Encrypted)* and `KeyDeliveryMessageID` parameter with a value that is the `MessageId` of the KDM used. Missing required elements or incorrect parameters shall be cause to fail this test.
 - b. Confirm the presence of a `CertFormatError` exception in the `KDMKeysReceived` log record. Record any additional parameters associated with the exception. A missing `CertFormatError` exception in the associated `KDMKeysReceived` log record shall be cause to fail this test.

Supporting Materials

Reference Documents	DCI-DCSS, 9.8, 9.4.3.5 SMPTE-430-1 SMPTE-430-3 SMPTE-430-5
Test Materials	<i>KDM with incorrect message digest</i> <i>KDM with incorrect signer thumbprint</i> <i>KDM without signer certificate</i> <i>KDM signed with incorrect signer certificate format</i> <i>DCI 2K StEM (Encrypted)</i>

Consolidated Test Sequences

Sequence	Type	Measured Data
15.2. Integrated IMB Test Sequence	Pass/Fail	—
21.2. Integrated IMBO Test Sequence	Pass/Fail	—

3.5.10. KDM NonCriticalExtensions Element (OBAE)

Objective

Verify that a decoding device does not reject a OBAE-capable KDM when the <NonCriticalExtensions> element is present and not empty.

Procedures

Perform an operation on the Test Subject using *KDM with non-empty NonCriticalExtensions (OBAE)*, a KDM that contains the <NonCriticalExtensions> element with child content. Verify that the operation is successful. A failed operation shall be cause to fail this test.

Supporting Materials

Reference Documents	DCI-DCSS, 9.8, 9.4.3.5 SMPTE-430-1 SMPTE-430-3
Test Materials	<i>KDM with non-empty NonCriticalExtensions (OBAE)</i> <i>DCI 2K StEM (OBAE) (Encrypted)</i>

Consolidated Test Sequences

Sequence	Type	Measured Data
20.2. OMB Test Sequence	Pass/Fail	—

3.5.11. ETM IssueDate Field Check (OBAE)

Objective

- Verify that the OBAE-capable Test Subject verifies that the signer's certificate is valid at the time when the KDM was issued.
- Verify that the OBAE-capable Test Subject verifies that the KDM validity does not extend beyond the ending validity period of the certificate.

Procedures

For each of the malformations below, perform an operation on the Test Subject using the test material that has that malformation. Verify that the operation fails. A successful operation is cause to fail this test.

1. KDM in which the certificate that signed the KDM has an ending validity date prior to the KDM issue date (*KDM with expired Signer certificate (OBAE)*).
2. KDM in which the certificate that signed the KDM has a starting validity date after the KDM issue date (*KDM issued before certificate valid (OBAE)*).
3. KDM in which the validity period extends beyond the end of the signing certificate's validity period (*KDM validity exceeds signer validity (OBAE)*).

Supporting Materials

Reference Documents	DCI-DCSS, 9.8, 9.4.3.5 SMPTE-430-1 SMPTE-430-3
Test Materials	<i>KDM with expired Signer certificate (OBAE)</i> <i>KDM issued before certificate valid (OBAE)</i> <i>KDM validity exceeds signer validity (OBAE)</i> <i>DCI 2K StEM (OBAE) (Encrypted)</i>

Consolidated Test Sequences

Sequence	Type	Measured Data
20.2. OMB Test Sequence	Pass/Fail	—

3.5.12. Structure ID Check (OBAE)

Objective

Verify that the OBAE-capable Test Subject checks the validity of the CipherData Structure ID as specified in [SMPTE-430-1] and rejects the KDM if the Structure ID is incorrect.

Procedures

Perform an operation on the Test Subject using *KDM with corrupted CipherData block (OBAE)*, a KDM with an invalid CipherData Structure. Verify that the operation fails. A successful operation is cause to fail this test.

Supporting Materials

Reference Documents	DCI-DCSS, 9.8, 9.4.3.5 SMPTE-430-1 SMPTE-430-3
Test Materials	<i>KDM with corrupted CipherData block (OBAE)</i> <i>DCI 2K StEM (OBAE) (Encrypted)</i>

Consolidated Test Sequences

Sequence	Type	Measured Data
----------	------	---------------

20.2. OMB Test Sequence	Pass/Fail	—
-------------------------	-----------	---

3.5.13. Certificate Thumbprint Check (OBAE)

Objective

Verify that the OBAE-capable Test Subject checks that the thumbprint of the signer's certificate matches the signer of the KDM and rejects the KDM if it does not.

Procedures

Perform an operation on the Test Subject using the KDM with a signer's certificate whose thumbprint does not match the thumbprint of the certificate used to sign the KDM (*KDM with incorrect signer thumbprint (OBAE)*). Verify that the operation fails. A successful operation is cause to fail this test.

Supporting Materials

Reference Documents	DCI-DCSS, 9.8, 9.4.3.5 SMPTE-430-1 SMPTE-430-3
Test Materials	<i>KDM with incorrect signer thumbprint (OBAE)</i> <i>DCI 2K StEM (OBAE) (Encrypted)</i>

Consolidated Test Sequences

Sequence	Type	Measured Data
20.2. OMB Test Sequence	Pass/Fail	—

3.5.14. KeyInfo Field Check (OBAE)

Objective

Verify that when KeyInfo elements are present in the <EncryptedKey> elements of the <AuthenticatedPrivate> area of the KDM, the OBAE-capable Test Subject verifies that they all match, and that the OBAE-capable Test Subject rejects the KDM if they do not match.

Procedures

Perform an operation on the Test Subject using the KDM with KeyInfo element values that do not match (*KDM with KeyInfo mismatch (OBAE)*). Verify that the operation fails. A successful operation is cause to fail this test.

Supporting Materials

Reference Documents	DCI-DCSS, 9.8, 9.4.3.5 SMPTE-430-1 SMPTE-430-3
Test Materials	<i>KDM with KeyInfo mismatch (OBAE)</i> <i>DCI 2K StEM (OBAE) (Encrypted)</i>

Consolidated Test Sequences

Sequence	Type	Measured Data
20.2. OMB Test Sequence	Pass/Fail	—

3.5.15. KDM Malformations (OBAE)

Objective

Verify that the OBAE-capable SM checks that the KDM is well formed and labeled with the correct namespace name.

Procedures

1. Perform an operation on the Test Subject using *KDM with invalid XML (OBAE)*, which contains XML that is not well-formed. If the operation succeeds this is cause to fail this test.
2. Perform an operation on the Test Subject using *KDM with invalid MessageType (OBAE)*, which contains an incorrect ETM <MessageType> value. If the operation succeeds this is cause to fail this test.
3. Perform an operation on the Test Subject using *KDM with expired Signer certificate (OBAE)*, which contains a KDM whose signing certificate has expired. If the operation succeeds this is cause to fail this test.
4. Perform an operation on the Test Subject using *KDM with incorrect namespace name value (OBAE)*, which contains an incorrect ETM namespace name. If the operation succeeds this is cause to fail this test.
5. Perform an operation on the Test Subject using *KDM with empty TDL (OBAE)*, which contains a TDL with no entries. If the operation succeeds this is cause to fail this test.
6. Extract a security log from the Test Subject and using a **Text Editor**, identify the KDMKeysReceived events associated with the above steps and:
 - a. Confirm that all required elements have correctly formatted parameters as defined in [SMPT-430-5]. Missing required elements or incorrect parameters shall be cause to fail this test.
 - b. For the log record produced by the operation using *KDM with invalid MessageType (OBAE)*, verify that the value of the SignerID parameter contains the Certificate Thumbprint of the signing certificate of *KDM with invalid MessageType (OBAE)*. Verify that ReferencedIDs element contains a KeyDeliveryMessageID parameter with a value that is the MessageId of *KDM with invalid MessageType (OBAE)*. Failure of any verification shall be cause to fail this test.
 - c. For the log record produced by the operation using *KDM with expired Signer certificate (OBAE)*, verify that the contentId element contains the Id of *DCI 2K StEM (OBAE) (Encrypted)*. Verify that the value of the SignerID parameter contains the Certificate Thumbprint of the signing certificate of *KDM with expired Signer certificate (OBAE)*. Verify that ReferencedIDs element contains a CompositionID parameter with a value that is the Id of *DCI 2K StEM (OBAE) (Encrypted)* and KeyDeliveryMessageID parameter with a value that is the MessageId of *KDM with expired Signer certificate (OBAE)*. Failure of any verification shall be cause to fail this test.

d. Confirm the presence of a `KDMFormatError` exception in each `KDMKeysReceived` log record. Record any additional parameters associated with the exception. A missing `KDMFormatError` exception in any of the associated `KDMKeysReceivedLog` records shall be cause to fail this test.

Supporting Materials

Reference Documents	DCI-DCSS, 9.4.6.3.8, 9.8, 9.4.3.5 SMPTE-430-1 SMPTE-430-3 SMPTE-430-5
Test Materials	<i>KDM with empty TDL (OBAE)</i> <i>KDM with expired Signer certificate (OBAE)</i> <i>KDM with invalid XML (OBAE)</i> <i>KDM with invalid MessageType (OBAE)</i> <i>KDM with incorrect namespace name value (OBAE)</i> <i>DCI 2K StEM (OBAE) (Encrypted)</i>

Consolidated Test Sequences

Sequence	Type	Measured Data
20.2. OMB Test Sequence	Pass/Fail	—

3.5.16. KDM Signature (OBAE)

Objective

Verify that the OBAE-capable Test Subject checks that the KDM signature is valid, including checking that the certificate that signed the KDM is included in the KDM and rejecting the KDM if it is not.

Procedures

1. Perform an operation on the Test Subject using *KDM with incorrect message digest (OBAE)*. The KDM *KDM with incorrect message digest (OBAE)* is invalid (wrong signature/hash error). If the operation succeeds this is cause to fail this test.
2. Perform an operation on the Test Subject using *KDM with incorrect signer thumbprint (OBAE)*. The KDM *KDM with incorrect signer thumbprint (OBAE)* is invalid (wrong signature identity). If the operation succeeds this is cause to fail this test.
3. Perform an operation on the Test Subject using *KDM without signer certificate (OBAE)*. The KDM *KDM without signer certificate (OBAE)* is invalid (broken certificate chain). If the operation succeeds this is cause to fail this test.
4. Extract a security log from the Test Subject and using a **Text Editor**, identify the `KDMKeysReceived` events associated with the above steps and:

- a. Confirm that all required elements have correctly formatted parameters as defined in [SMPTE-430-5]. Verify that the `contentId` element contains the Id of *DCI 2K StEM (OBAE) (Encrypted)*. Verify that `ReferencedIDs` element contains a `CompositionID` parameter with a value that is the Id of *DCI 2K StEM (OBAE) (Encrypted)* and `KeyDeliveryMessageID` parameter with a value that is the `MessageId` of the KDM used. Missing required elements or incorrect parameters shall be cause to fail this test.
 - b. For the log records produced by the operation using *KDM with incorrect message digest (OBAE)* and *KDM with incorrect signer thumbprint (OBAE)*, verify that the value of the `SignerId` parameter contains the Certificate Thumbprint of the signing certificate of the KDM.
 - c. Confirm the presence of a `SignatureError` exception in each `KDMKeysReceived` log record. Record any additional parameters associated with the exception. A missing `SignatureError` exception in any of the associated `KDMKeysReceived` log records shall be cause to fail this test.
5. Perform an operation on the Test Subject using *KDM signed with incorrect signer certificate format (OBAE)*. The KDM *KDM signed with incorrect signer certificate format (OBAE)* is invalid (wrong signer certificate format). If the operation succeeds this is cause to fail this test.
6. Extract a security log from the Test Subject and using a **Text Editor**, identify the `KDMKeysReceived` event associated with the above step and:
- a. Confirm that all required elements have correctly formatted parameters as defined in [SMPTE-430-5]. Verify that the `contentId` element contains the Id of *DCI 2K StEM (OBAE) (Encrypted)*. Verify that `ReferencedIDs` element contains a `CompositionID` parameter with a value that is the Id of *DCI 2K StEM (OBAE) (Encrypted)* and `KeyDeliveryMessageID` parameter with a value that is the `MessageId` of the KDM used. Missing required elements or incorrect parameters shall be cause to fail this test.
 - b. Confirm the presence of a `CertFormatError` exception in the `KDMKeysReceived` log record. Record any additional parameters associated with the exception. A missing `CertFormatError` exception in the associated `KDMKeysReceived` log record shall be cause to fail this test.

Supporting Materials

Reference Documents	DCI-DCSS, 9.8, 9.4.3.5 SMPTE-430-1 SMPTE-430-3 SMPTE-430-5
Test Materials	<i>KDM with incorrect message digest (OBAE)</i> <i>KDM with incorrect signer thumbprint (OBAE)</i> <i>KDM without signer certificate (OBAE)</i> <i>KDM signed with incorrect signer certificate format (OBAE)</i> <i>DCI 2K StEM (OBAE) (Encrypted)</i>

Consolidated Test Sequences

Sequence	Type	Measured Data
----------	------	---------------

20.2. OMB Test Sequence	Pass/Fail	—
-------------------------	-----------	---

Chapter 4. Digital Cinema Packaging

The DCP is the file format for d-cinema content. Entire suites of standards documents from SMPTE define this format, most notably the 428 and 429 multi-part documents. In addition, many IETF documents and some ISO documents are referenced from the SMPTE works. Reading and understanding all of these documents is a substantial task, but it is essential knowledge for accurate and efficient analysis of d-cinema files

In the following procedures, simple tools are used to display the contents of d-cinema files. Example output from these tools is shown with descriptions of the features that will be interesting to the Test Operator. In addition to the tools used in this text, the Test Operator may use more sophisticated methods so long as the results obtained are equivalent to the procedures presented here. The reader should also note that a programmer's **Text Editor** and a binary viewer or editor are essential tools for direct inspection of data.

4.1. Asset Map

D-cinema track files and composition playlists are identified by unique, embedded identifiers. These identifiers, called *UUIDs*, are defined by [RFC-4122]. d-cinema XML files use UUIDs to refer to other d-cinema XML files and MXF files (assets). When d-cinema assets are written to a filesystem, a mechanism is needed to relate the UUID values to filename values in the filesystem. An Asset Map is an XML document that provides a mapping from UUID values to filesystem paths. When a d-cinema package is written to a volume, an Asset Map is created that includes the size and location of every file in the package¹.

¹ Or packages; volumes can contain multiple DCPs.

Along with the Asset Map, each volume has a Volume Index file. The Volume Index file is used to differentiate volumes in a multiple-volume distribution. Both Asset Maps and Volume Indexes are XML files (as described in [Section 3.1](#)). The formats of the Asset Map file and the Volume Index file are specified in [SMPTE-429-9]

```

<?xml version="1.0" encoding="UTF-8"?> 1
<AssetMap xmlns="http://www.smpte-ra.org/schemas/429-9/2007/AM"> 2
  <Id>urn:uuid:425e93f7-bca2-4255-b8ec-8c7d16fc8881</Id> 3
  <Creator> Packaging Tools v1.0 </Creator> 4
  <VolumeCount>1</VolumeCount> 5
  <IssueDate>2007-07-06T18:25:42-00:00</IssueDate> 6
  <Issuer>user@host</Issuer> 7
  <AssetList> 8
    <Asset> 9
      <Id>urn:uuid:034b95b0-7424-420f-bbff-a875a79465a5</Id> 10
      <PackingList>true</PackingList> 11
      <ChunkList> 12
        <Chunk> 13
          <Path>perfect_movie_domestic_51.pkl.xml</Path> 14
          <VolumeIndex>1</VolumeIndex> 15
          <Offset>0</Offset> 16
          <Length>14366</Length> 17
        </Chunk>
      </ChunkList>
    </Asset>
    <Asset>
      <Id>urn:uuid:4f89a209-919b-4f21-a1d6-21ad32581115</Id>
      <ChunkList>
        <Chunk>
          <Path>perfect_movie_j2c_r01.mxf</Path>
          <VolumeIndex>1</VolumeIndex>
          <Offset>0</Offset>
          <Length>342162304</Length>
        </Chunk>
      </ChunkList>
    </Asset>
    <Asset>
      <Id>urn:uuid:e522f7b6-6731-4df5-a80e-8cfd74f82219</Id>
      <ChunkList>
        <Chunk>
          <Path>perfect_movie_wav_r01.mxf</Path>
          <VolumeIndex>1</VolumeIndex>
          <Offset>0</Offset>
          <Length>34591246</Length>
        </Chunk>
      </ChunkList>
    </Asset>
    [additional assets omitted for brevity]
    ...
  </AssetList>
</AssetMap>

```

- 1 XML Declaration. This specifies the version of the XML standard to which the document conforms, and the character encoding of the document.
- 2 The root Assetmap element. This element contains the XML namespace declaration for an Assetmap as specified in [SMPTE-429-9].
- 3 The Unique Universal ID (UUID) of the asset map. This is used to uniquely identify the asset map
- 4 The person, software, or system that generated the asset map.
- 5 The Volume count indicates the total number of volumes that are referenced by the asset map
- 6 The date the asset map was issued.
- 7 The organization or entity that issued the asset map.
- 8 The AssetList contains all of the assets in the asset map. Each asset is described in an Asset sub-element of the AssetList
- 9 The Asset element contains all the data about an asset necessary to locate it in the filesystem.
- 10 The Asset UUID is the unique ID of a particular asset in the asset map
- 11 The Packinglist element identifies whether or not the asset being described is a Packing List document
- 12 The Chunklist contains the list of chunks that comprise the complete asset

- 13 The Chunk element
- 14 The asset chunk path is the path and filename, in the file system, of the file that contains the asset data
- 15 The chunk volume index indicates the volume number on which the chunk resides
- 16 The chunk offset is the number of bytes from the beginning of the complete asset file that this chunk begins. A chunk that is either a complete file or that is the beginning of a file will have an offset of 0.
- 17 The chunk length is the length, in bytes, of the chunk of the asset

Example 4.1. Asset Map

```
<?xml version="1.0" encoding="UTF-8"?> 1
<VolumeIndex xmlns="http://www.smpte-ra.org/schemas/429-9/2007/AM"> 2
<Index>1</Index> 3
</VolumeIndex>
```

- 1 XML Declaration. This specifies the version of the XML standard to which the document conforms, and the character encoding of the document
- 2 The root Assetmap element. This element contains the XML namespace declaration for an Assetmap as specified in [SMPTE-429-9].
- 3 The index number of the volume.

Example 4.2. Volume Index

4.1.1. Asset Map File

Objective

Verify that the Asset Map file is in the root of the volume, and that it is named ASSETMAP.xml. Verify that the Asset Map validates against the schema defined in [SMPTE-429-9].

Procedures

1. Mount the media that contains the volume with a computer, and obtain a directory listing of the root of the filesystem. The absence of the file ASSETMAP.xml is cause to fail this test.
2. Using the **schema-check** software utility, validate the file ASSETMAP.xml against the schema in [SMPTE-429-9]. Failure to correctly validate is cause to fail this test. For more information on schema validation see [Section 1.4: Conventions and Practices](#)

E.g.:

```
$ cd /
$ ls -F
ASSETMAP.xml
PKL_c2434860-7dab-da2b-c39f-5df000eb2335.xml
J2K_a13c59ec-f720-1d1f-b78f-9bdea4968c7d_video.mxf
WAV_22d190bd-f43b-a420-a12e-2bf29a737521_audio.mxf
...
$
$ schema-check ASSETMAP.xml smpte-429-9.xsd
schema validation successful
$
```

Supporting Materials

Reference Documents	DCI-DCSS, 5.5.2.1 SMPTE-429-9
----------------------------	----------------------------------

Test Equipment	schema-check
-----------------------	---------------------

4.1.2. Volume Index File

Objective

Verify that the Volume Index file is in the root of the volume and that it is named VOLINDEX.xml. Verify that the Volume Index file validates against the schema defined in [SMPTE-429-9].

Procedures

1. Mount the media that contains the volume with a computer, and obtain a directory listing of the root of the filesystem. The absence of the file VOLINDEX.xml is cause to fail this test.
2. Using the **schema-check** software utility, validate the file VOLINDEX.xml against the schema in [SMPTE-429-9]. Failure to correctly validate is cause to fail this test. For more information on schema validation see Section 1.4: Conventions and Practices.

E.g.:

```

$ cd /
$ ls -F
VOLINDEX.xml
PKL_c2434860-7dab-da2b-c39f-5df000eb2335.xml
J2K_a13c59ec-f720-1d1f-b78f-9bdea4968c7d_video.mxf
WAV_22d190bd-f43b-a420-a12e-2bf29a737521_audio.mxf
...
$
$ schema-check VOLINDEX.xml smpte-429-9.xsd
schema validation successful
$

```

Supporting Materials

Reference Documents	DCI-DCSS, 5.5.2.1 SMPTE-429-9
Test Equipment	schema-check

4.2. Packing List

The Packing List (PKL) is an XML document (see Section 3.1) that specifies the contents of a d-cinema Package. It contains the UUID, file type (MXF track file, CPL, etc.), and a message digest of each file in the DCP. This information is used to ensure that all of the expected files have been included and have not been modified or corrupted in transit. The format of the Packing List file is specified by [SMPTE-429-8].

```

<?xml version="1.0" encoding="UTF-8" standalone="no"?> 1
<PackingList xmlns="http://www.smpte-ra.org/schemas/429-8/2007/PKL"> 2
  <Id>urn:uuid:59430cd7-882d-48e8-a026-aef4b6253dfc</Id> 3
  <AnnotationText>Perfect Movie DCP</AnnotationText> 4
  <IssueDate>2007-07-25T18:21:31-00:00</IssueDate> 5
  <Issuer>user@host</Issuer> 6
  <Creator>Packaging Tools v1.0</Creator> 7
  <AssetList> 8
    <Asset> 9
      <Id>urn:uuid:24d73510-3481-4ae5-b8a5-30d9eeced9c1</Id> 10
      <Hash>AXufMKY7NyZcfSXQ9sCZls5dSyE=</Hash> 11
      <Size>32239753</Size> 12
      <Type>application/mxf</Type> 13
    </Asset>
    <Asset>
      <Id>urn:uuid:456e547d-af92-4abc-baf3-c4d730bbcd65</Id>
      <Hash>kAAo0kXYVDBJUpHID89zauv50w=</Hash>
      <Size>86474446</Size>
      <Type>application/mxf</Type>
    </Asset>
    <Asset>
      <Id>urn:uuid:e4a4e438-63ec-46cb-b9aa-43acee787d79</Id>
      <Hash>kt5bP8y4zmHNAY1qVnujItAb4sY=</Hash>
      <Size>12163</Size>
      <Type>text/xml</Type>
    </Asset>
    <Asset>
      <Id>urn:uuid:3d445456-54d5-42bc-a7cc-a8c00b20ffb7</Id>
      <Hash>AQWMCxxMv001zTS3Y30j8M+d9s=</Hash>
      <Size>62500144</Size>
      <Type>application/mxf</Type>
    </Asset>
    [Remaining assets and signature omitted for brevity]
  </AssetList>
  [Signature omitted for brevity]
</PackingList>

```

- 1 XML Declaration. This specifies the version of the XML standard to which the document conforms
- 2 The root packing list element. This element contains the XML namespace declaration for the packing list as specified in[SMPTE-429-8]
- 3 The Unique Universal ID (UUID) of the packing list
- 4 The Annotation text is a plain text, human readable language description of the packing list's contents
- 5 The date the packing list was issued
- 6 The organization or entity that issued the packing list
- 7 The person, software, or system that generated the packing list
- 8 The assetlist contains all of the assets in the packing list
- 9 The Asset element contains all the metadata necessary to identify the file
- 10 The Asset UUID is the unique ID of a particular asset in the packing list
- 11 The asset hash is a message digest of the asset file
- 12 The asset size is the size, in bytes, of the asset's file in the filesystem
- 13 The asset type contains the mime type of the asset, which is a generic description of the file format. It also contains an attribute that specifies the specific kind of type, such as a CPL, Picture, or Sound file

Example 4.3. Packing List

4.2.1. Packing List File

Objective

- Verify that the Packing List is an XML document and that it validates against the schema defined in [SMPTE-429-8].
- Confirm that if the `language` attribute of the `<AnnotationText>` element is not present, or present with a value of "en", that the Annotation text is in human-readable English.
- Verify that the Packing List contains urn:uuid values as specified in [RFC-4122].
- Verify that the listed file sizes match those for each of the referenced assets.

Procedures

In the following procedures, the callout numbers refer to [Example 4.3](#).

1. Using the **schema-check** software utility, validate the XML file structure against the schema in [SMPTE-429-8]. Failure to correctly validate is cause to fail this test. For more information on schema validation see [Section 1.4: Conventions and Practices](#).

```
$ schema_check.py <input-file> smpte-429-8.xsd
schema validation successful
$
```

2. Open the Packing List file in a **Text Editor** and verify that if the "language" attribute of the `<AnnotationText>` [4](#) element is not present, or present with a value of "en", that the contents of the `<AnnotationText>` [4](#) element is human readable English. Failure to meet this requirement is cause to fail this test.

```
$ vi <input-file>
...
<AnnotationText>Perfect Movie Reel #1 Picture</AnnotationText>
...
<AnnotationText language="en">Perfect Movie Reel #1 Sound</AnnotationText>
...
:q
$
```

3. Supply the filename of the Packing List file as an argument to the **uuid_check.py** software utility. Examine the output for error messages that identify expected UUID values that do not conform to the format specified in [RFC-4122]. One or more occurrences is cause to fail this test.

```
$ uuid_check.py <input-file>
all UUIDs conform to RFC-4122
$
```

4. To verify that the real file sizes of the referenced assets are equal to the values of the related XML elements, the path to those assets must be known. The following procedure may be used if the `ASSETMAP.xml` file is available, otherwise the tester will need to devise a method for locating the relevant assets. For each of the `<Asset>` [9](#) elements contained in the Packing List, compare the contents of the child `<Id>` [10](#) element with the contents of the `ASSETMAP.xml` file to discover the path to the asset. List the file size of the referenced asset and verify that it is identical to the value of the child `<Size>` [12](#) element inside the `<Asset>` [9](#) element. One or more failures to verify the file sizes is cause to fail this test.

Supporting Materials

Reference Documents	DCI-DCSS, 5.5.3.1, 5.5.3.2 SMPTE-429-8
Test Equipment	schema-check uuid_check.py Text Editor

4.2.2. Packing List Signature Validation

Objective

Verify that the Packing List is signed and that the signature validates.

Procedures

Using the **checksig** software utility, verify that there is a signature included in the Packing List and that it is valid. If the signature is missing or invalid, this is cause to fail this test. Note: Depending on the order of the certificates contained in the log report, the **dsig_cert.py** program may need to be used to re-order the certificates for the **checksig** program. Example:

```
$ dsig_cert.py <pk1-file.pkl.xml> > tmp.xml  
$ checksig tmp.xml  
The supplied signature is valid  
$
```

Supporting Materials

Reference Documents	DCI-DCSS, 5.5.2.3, 5.5.3.2 PKCS-1 RFC-3174 SMPTE-429-8
Test Equipment	checksig dsig_cert.py

4.3. Composition Playlist

The Composition Playlist (CPL) is an XML document (see [Section 3.1](#)) that contains the information necessary to reproduce a composition. It contains metadata about the composition such as the title and the rating, and references to the track files that contain the composition's essence. The format of the Composition Playlist file is specified by [SMPTE-429-7].

```

<?xml version="1.0" encoding="UTF-8" standalone="no"?> 1
<CompositionPlaylist xmlns="http://www.smpte-ra.org/schemas/429-7/2006/CPL"> 2
  <Id>urn:uuid:20670ba3-d4c7-4539-ac3e-71e874d4d7d1</Id> 3
  <IssueDate>2007-07-25T00:35:03-00:00</IssueDate> 4
  <Issuer>user@host</Issuer> 5
  <Creator> Packaging Tools v1.0 </Creator> 6
  <ContentTitleText>Perfect Movie</ContentTitleText> 7
  <ContentKind>feature</ContentKind> 8
  <ContentVersion> 0
    <Id>urn:uuid:e5a1b4dc-faf3-461b-a5e2-9d33088b1b28</Id> 10
    <LabelText>Perfect Movie - Domestic - US 5.1 </LabelText> 11
  </ContentVersion>
  <RatingList /> 12
  <ReelList> 13
    <Reel> 14
      <Id>urn:uuid:f62cffe9-2da7-4d28-b73e-f21c816ab02f</Id> 15
      <AssetList> 16
        <MainPicture> 17
          <Id>urn:uuid:93270dd0-8675-42fa-9ce8-34b61c963997</Id> 18
          <EditRate>24 1</EditRate> 19
          <IntrinsicDuration>480</IntrinsicDuration> 20
          <EntryPoint>0</EntryPoint> 21
          <Duration>480</Duration> 22
          <FrameRate>24 1</FrameRate> 23
          <ScreenAspectRatio>1998 1080</ScreenAspectRatio> 24
        </MainPicture> 25
        <MainSound> 26
          <Id>urn:uuid:e33b7b37-da90-4429-88af-5c5b63506017</Id>
          <EditRate>24 1</EditRate>
          <IntrinsicDuration>2880</IntrinsicDuration>
          <EntryPoint>120</EntryPoint>
          <Duration>2760</Duration>
        </MainSound>
      </AssetList>
    </Reel>
  </ReelList>
  [Additional reel data and CPL Signature omitted for brevity]
</CompositionPlaylist>

```

- 1 The XML version of the XML standard to which the document conforms, the character encoding of the document, and whether the document relies on external declarations or parameter entities.
- 2 The Root Composition Playlist element. This element contains the XML namespace declaration for the Composition Playlist as specified in [SMPTE-429-7].
- 3 The Unique Universal ID (UUID) of the composition playlist.
- 4 The date the CPL was issued
- 5 The organization or entity that issued the CPL
- 6 The person, software, or system that generated the CPL
- 7 A descriptive string that describes the composition and is displayed to the user
- 8 The kind of presentation the CPL represents, such as a feature, trailer, or advertisement
- 0 The version of the content represented by the composition playlist. This element contains sub-elements that contain a descriptive label and UUID of the content
- 10 The unique ID of the version of the content represented by the CPL (as opposed to the unique ID of the CPL)
- 11 A text description of the version of the content represented in the CPL
- 12 The list of ratings applied to the content represented by the CPL. In compositions that contain rating information, the <RatingList> element contains at least one instance of the <Rating> element, which in turn contains two elements, <Agency>, that contains a URI that represents the agency that issued the rating, and <Label>, that contains the rating
- 13 The list of reels that comprise the composition
- 14 A reel of the composition
- 15 The unique ID of the reel

- 16 The list of assets that comprise the reel
- 17 The element in the reel that contains the information required to produce images onscreen
- 18 The unique ID of the MXF track file that contains the picture essence (the picture track file) to be reproduced onscreen
- 19 The edit rate, or the number of editable units of content, per second, of the picture track file
- 20 The total number of frames in the track file, inclusive of frames not intended for reproduction onscreen
- 21 The first frame of the track file to be reproduced onscreen
- 22 The number of frames of the track file to be reproduced onscreen. When a picture track file is present in a composition, its duration is effectively the duration of the reel
- 23 The rate, in frames-per-second, at which the essence in the track file will be reproduced
- 24 The aspect ratio of the essence in the picture track file. This is represented in the CPL as a ratio of two numbers separated by a space
- 25 The closing tag of the reel's MainPicture element
- 26 The element in the reel that contains the information required to reproduce sound essence through the primary speaker system. The parameters of a MainSound track file are the same as those of a picture track file

Example 4.4. Composition Playlist

4.3.1. Composition Playlist File

Objective

Verify that the Composition Playlist is an XML document and that it validates against the schema defined in [SMPTE-429-7].

Procedures

Using the **schema-check** software utility, validate the XML file structure against the schema in [SMPTE-429-7]. Failure to correctly validate is cause to fail this test.

```
$ schema-check <input-file> smpte-429-7.xsd
schema validation successful
$
```

Supporting Materials

Reference Documents	DCI-DCSS, 5.2.3, 5.4.2, 5.4.3, 9.7.7, 5.4.3.2, 5.4.3.3, 5.4.3.4 SMPTE-429-7
Test Equipment	schema-check

4.3.2. Composition Playlist Signature Validation

Objective

Verify that the Composition Playlist is signed and that the signature validates.

Procedures

Using the **checksig** software utility, verify that there is a signature included in the Composition Playlist List and that it is valid. If the signature is missing or invalid, this is cause to fail this test. Note: Depending on the order of the certificates contained in the log report, the **dsig_cert.py** program may need to be used to re-order the certificates for the **checksig** program. Example:

```
$ dsig_cert.py <cpl-file.cpl.xml> > tmp.xml
$ checksig tmp.xml
The supplied signature is valid
$
```

Supporting Materials

Reference Documents	DCI-DCSS, 5.2.3, 5.4.3.6, 5.4.4, 9.7.5
Test Equipment	dsig_cert.py checksig

4.3.3. Composition Playlist Key Usage

Objective

An encrypted Asset is associated with a Decryption Key that is effective for a period of time equal to one Reel. Only one Decryption Key shall be associated with a specific encrypted Asset. Each unique Decryption Key shall be associated with only one encrypted Asset.

- Verify that for each encrypted Asset present in the Composition Playlist, only one <KeyId> value is listed. If an Asset Id occurs more than once in the CPL, verify that the same <KeyId> is utilized throughout.
- Verify that each <KeyId> is associated with only one Asset Id.

Procedures

1. Use a **Text Editor** to view the Composition Playlist. For all encrypted Assets (those that have a <KeyId> value) make a list of all Asset Id values and the associated <KeyId> values.
2. Examine the list to determine that each Asset Id has exactly one <KeyId>. If Asset Ids are repeated in the CPL, the same <KeyId> should be associated for that Asset every time. Any deviation is cause to fail this test.
3. Examine the list to determine that each <KeyId> is associated with exactly one Asset Id (*i.e.* a particular Decryption Key should only be associated with one, unique Asset). Any deviation is cause to fail this test.

Supporting Materials

Reference Documents	DCI-DCSS, 5.3.1.7
Test Equipment	Text Editor

4.4. Track Files

A Track File is a container for encoded essence. In the d-cinema system, each Track File contains a single track of a single type of essence. For example, a Track File may contain images or sound or timed text, but never more than one type of essence².

² Strictly speaking, a Timed Text Track File may contain font and image resources in addition to the XML timed text data, but these resources are considered integral to the timed text essence.

D-cinema Track Files are based on the Material eXchange Format (MXF). MXF is a file metaformat, *i.e.*, a file format for creating file formats. While the various d-cinema Track File formats represent different methods of encoding essence data, the arrangement of metadata within the files is syntactically similar. This section will provide an overview of MXF as used for d-cinema applications. Readers looking for more detailed technical information are referred to [SMPTE-377-1]

4.4.1. MXF Internals

4.4.1.1. Overview

Before diving head-first into examining MXF files, it is important to understand the structure of the files. This section will briefly describe the contents of some example MXF files by displaying the files' header metadata using the **klvwalk** software utility from the free ASDCLib software package.

Briefly, an MXF file [SMPTE-377-1] contains a sequence of Key-Length-Value (KLV) packets. Some packets carry essence and some carry metadata. MXF files are divided into *partitions*. Each partition is comprised of a set of KLV packets. The first KLV packet in each partition is a Partition Pack.

The number of partitions in a digital cinema sound or picture Track File is usually three (Timed Text Track Files may have more than three partitions). The first partition in an MXF file contains the metadata which describe the coding parameters of the essence and the MXF file itself. The second partition contains the essence data as a sequence of KLV-wrapped frames. The final partition contains the index table

To display the metadata in the header partition of an MXF file `testfile.mxf`, use **klvwalk** like so

```
$ klvwalk -r testfile.mxf
...
```

The following sections illustrate the expected output

4.4.1.2. MXF Header Partition

As shown in [Example 4.5](#), the first structure to be output is the Partition Pack of the Header Partition. This structure documents the MXF version that the file conforms to and provides a description of the general architecture to be found inside

```
06.0e.2b.34.02.05.01.01.0d.01.02.01.01.02.04.00 len: 120 (ClosedCompleteHeader) 1
  MajorVersion = 1
  MinorVersion = 2
  KAGSize = 1
  ThisPartition = 0
  PreviousPartition = 0
  FooterPartition = 218362864
  HeaderByteCount = 16244
  IndexByteCount = 0
  IndexSID = 0
  BodyOffset = 0
  BodySID = 1
  OperationalPattern = 060e2b34.0401.0101.0d010201.10000000 2
Essence Containers: 3
  060e2b34.0401.0103.0d010301.027f0100
  060e2b34.0401.0107.0d010301.020b0100
```

- 1** This is an MXF Partition Pack structure. The Universal Label (UL) value indicates that the file is "Closed and Complete".
- 2** The Operational Pattern UL indicates that the file conforms to OP Atom [SMPTE-390]
- 3** Essence Container labels indicate the type of essence and the wrapping format. This example shows two container labels: the JPEG 2000 container [SMPTE-422] and the Generic Container [SMPTE-379-1] (the file contains encrypted JPEG 2000 essence)

Example 4.5. MXF Partition Header

The following table gives the list of valid Essence Container ULs for d-cinema Track File

Table 4.1. Essence Container UL Values for D-Cinema

UL Value	Container Type
060e2b34.0401.0101.0d010301.02060100	Linear PCM Audio [SMPTE-429-3], [SMPTE-382]
060e2b34.0401.0107.0d010301.020c0100	JPEG 2000 Images [SMPTE-429-4]
060e2b34.0401.010a.0d010301.02130101	Timed Text [SMPTE-429-5]
060e2b34.0204.0101.0d010301.027e0100	Encrypted Essence [SMPTE-429-6]

4.4.1.3. File Package

An MXF file may contain zero or more continuous segments of essence data. Each segment is described by a Source Package structure. Per [SMPTE-429-3], MXF files for digital cinema must contain exactly one top-level Source Package (thus one segment of essence), referred to in MXF jargon as a File Package. [Example 4.6](#) shows a Source Package structure that points to JPEG 2000 essence data.

```
06.0e.2b.34.02.53.01.01.0d.01.01.01.01.01.37.00 len: 294 (SourcePackage) ❶
  InstanceUID = 42b5a376-c740-42e2-99f1-4ec782c4837e
  PackageUID = [060a2b34.0101.0105.01010f20],13,00,00,00,
               [b4f492cd.b89b.0f65.490c35ec.5f6340b7] ❷
  Name = File Package: SMPTE 429-4 frame wrapping of JPEG 2000 codestreams
  PackageCreationDate = 2007-03-21 07:42:04.000
  PackageModifiedDate = 2007-03-21 07:42:04.000
  Tracks: ❸
  9227a330-7e64-4c90-b4ef-d057ed6ef159
  0de983e3-255b-4d26-bde7-f33c530c077d
  54e13d93-abcfc-4869-b008-c59573b8d01d
  Descriptor = c6a35640-d6d8-433c-82c9-23df2eae9311 ❹
```

- ❶ This is a Source Package structure [SMPTE-377-1]
- ❷ A Unique Material Identifier (UMID) value which identifies the essence in the file. It has a UUID component which is the value that external entities (e.g. Packing Lists and Composition Playlists) use to refer to the essence in the file. See [SMPTE-429-3] for details about how d-cinema UMIDs are formed
- ❸ The list of tracks that appear in the file. There is only one essence track, but it is accompanied by a virtual timecode track and, optionally, a descriptive metadata track that gives cryptographic information (see [Section 4.4.1.4](#) below).
- ❹ This value gives the internal ID of a data set that describes the essence encoding. This set is called an Essence Descriptor. Two examples of essence descriptors are given below in [Section 4.4.1.5](#) and [Section 4.4.1.6](#)

Example 4.6. Source Package structure

4.4.1.4. Encrypted Essence

If the MXF file contains encrypted essence, the header metadata will contain one Cryptographic Framework set with a link to a single Cryptographic Context set (defined in [SMPTE-429-6]). These structures are shown in [Example 4.7](#)

```

06.0e.2b.34.02.53.01.01.0d.01.04.01.02.01.00.00 len: 40 (CryptographicFramework) 1
    InstanceUID = b98ca683-2e49-4e6a-88ff-af33910ba334
    ContextSR = 8dcd2f7b-fd0b-4602-bae7-806c82dcfd94

06.0e.2b.34.02.53.01.01.0d.01.04.01.02.02.00.00 len: 120 (CryptographicContext) 2
    InstanceUID = 8dcd2f7b-fd0b-4602-bae7-806c82dcfd94
    ContextID = 3472d593-e9ff-4b2e-84ca-5303b5ce53f7
    SourceEssenceContainer = 060e2b34.0401.0107.0d010301.020c0100 3
    CipherAlgorithm = 060e2b34.0401.0107.02090201.01000000 4
    MICAlgorithm = 060e2b34.0401.0107.02090202.01000000 5
    CryptographicKeyID = c030f37a-bf84-496b-bdc2-81744205a944 6

```

- 1** This is a Cryptographic Framework structure [SMPTE-429-6]
- 2** This is a Cryptographic Context structure [SMPTE-429-6]
- 3** A UL that identifies the type of essence inside the encrypted container. It should be a JPEG 2000 or PCM audio descriptor.
- 4** A UL that identifies the type of encryption used. This value should always be 060e2b34.0401.0107.02090201.01000000
- 5** A UL that identifies the algorithm used to calculate the Message Integrity Check value in each Encrypted KLV (EKL) packet. When present, this value should always be 060e2b34.0401.0107.02090202.01000000
- 6** A UUID value that identifies the 16-byte symmetric key (stored externally) that is required to decrypt the essence data. The key is usually delivered to a system via a Key Delivery Message (see Chapter 3)

Example 4.7. Cryptographic Framework and Cryptographic Context

4.4.1.5. Essence Descriptor for JPEG 2000

If the MXF file contains image essence for DCI-compliant digital cinema, the header metadata will contain an RGBA Essence Descriptor (defined in [SMPTE-377-1]), with a strong link to a JPEG 2000 Picture SubDescriptor (defined in [SMPTE-422]). These structures are shown in [Example 4.8](#)

```

06.0e.2b.34.02.53.01.01.0d.01.01.01.01.01.29.00 len: 169 (RGBAEssenceDescriptor) ❶
    InstanceUID = 18a47da5-53d1-4785-a91e-41155753a02f
    Locators:
    SubDescriptors:
    05f80258-beb2-4769-b99a-af4d6c3895da
        LinkedTrackID = 2
        SampleRate = 24/1 ❷
    ContainerDuration = 720 ❸
    EssenceContainer = 060e2b34.0401.0107.0d010301.020c0100
        Codec = 00000000.0000.0000.00000000.00000000
        FrameLayout = 0
        StoredWidth = 2048 ❹
        StoredHeight = 1080 ❺
        AspectRatio = 2048/1080
    PictureEssenceCoding = 060e2b34.0401.0109.04010202.03010103 ❻
    ComponentMaxRef = 4095
    ComponentMinRef = 0

06.0e.2b.34.02.53.01.01.0d.01.01.01.01.01.5a.00 len: 174 (JPEG2000PictureSubDescriptor) ❼
    InstanceUID = 05f80258-beb2-4769-b99a-af4d6c3895da
        Rsize = 3
        Xsize = 2048
        Ysize = 1080
        X0size = 0
        Y0size = 0
        XTsize = 2048
        YTsize = 1080
        XT0size = 0
        YT0size = 0
        Csize = 3
    PictureComponentSizing = 00000003000000030b01010b01010b0101
    CodingStyleDefault = 0104000101050303000077888888888888
    QuantizationDefault = 227f187f007f007ebc76ea76ea76bc6f4c6f4c6f645803580358455fd25fd25f61

```

- ❶ This is an MXF RGBA Essence Descriptor structure
- ❷ The frame rate of the underlying essence. The essence may be sampled on a finer scale, but this value is the smallest temporal increment than can be accessed in the file
- ❸ The number of frames in the file. Divide this value by the SampleRate to get the duration as a time value in seconds
- ❹ The width of the encoded image as a count of pixels.
- ❺ The height of the encoded image as a count of pixels
- ❻ This UL value indicates the type of compression and the color space of the encoded essence
- ❼ This is an MXF JPEG 2000 Picture SubDescriptor structure. It provides additional metadata associated with the JPEG 2000 encoding

Example 4.8. Essence Descriptor for JPEG 2000

4.4.1.6. Essence Descriptor for PCM Audio

If the MXF file contains audio essence for DCI-compliant digital cinema, the header metadata will contain a Wave Audio Descriptor (defined in [SMPTE-382]). This structure is shown in [Example 4.9](#).

```

06.0e.2b.34.02.53.01.01.0d.01.01.01.01.01.48.00 len: 134 (WaveAudioDescriptor) 1
  InstanceUID = 0b7eac6c-85e2-47e4-b0bf-b3e60f6e6cd7
  Locators:
  SubDescriptors:
  LinkedTrackID = 2
  SampleRate = 24/1 2
  ContainerDuration = 528 3
  EssenceContainer = 060e2b34.0401.0101.0d010301.02060100
  AudioSamplingRate = 48000/1 4
  Locked = 0
  AudioRefLevel = 0
  ChannelCount = 6 5
  QuantizationBits = 24 6
  DialNorm = 0
  BlockAlign = 18 7
  SequenceOffset = 0
  AvgBps = 144000

```

- 1 This is a Wave Audio Descriptor structure [SMPTE-382]
- 2 The frame rate of the underlying essence. The essence may be sampled on a finer scale, but this value is the smallest temporal increment than can be accessed in the file.
- 3 The number of frames in the file. Divide this value by the SampleRate to get the duration as a time value in seconds.
- 4 The base sample rate of the essence.
- 5 The number of channels in the file. Each frame of essence will have the same number of channels, multiplexed in the same order
- 6 The number of bits used to encode a sample of a single channel.
- 7 The size, in bytes, of a set of samples for all channels in a single sample period. This value should be equal to $(QuantizationBits / 8) * ChannelCount$.

Example 4.9. Essence Descriptor for PCM Audio

4.4.1.7. Random Index Pack (R.I.P.)

All d-cinema Track Files end with a Random Index Pack (RIP). The RIP provides a lookup table that gives the location of all partitions in the file for easy random access. The number of partitions shown by the RIP should be three if the MXF file is a sound or picture Track File, and may be more than three for a Timed Text Track File.

```

06.0e.2b.34.02.05.01.01.0d.01.02.01.01.11.01.00 len: 40 (RandomIndexMetadata)1 1
0      : 0
1      : 16384
0      : 110688380

```

- 1 The Random Index Pack (RIP) maps the location of each partition in an MXF file. This example shows three partitions

Example 4.10. MXF Random Index Pack (RIP)

4.4.2. Image and Audio Packaging Standard

Objective

- Verify that sound and image essence are wrapped in files conforming to Material Exchange Format (MXF) as defined by [SMPTE-377-1], and further constrained by [SMPTE-379-1], [SMPTE-429-3], and [SMPTE-429-4], [SMPTE-422] for image, or [SMPTE-382] for sound.
- If the Essence Container is encrypted, verify that this conforms to [SMPTE-429-6].

Procedures

1. Using the **klvwalk** software utility, produce a listing of the MXF KLV Header Metadata Structure. Error free completion of the command confirms the validity of the MXF structure. Any other result is cause to fail the test.

2. Examine the listing for the MXF Partition Pack structure with a ClosedCompleteHeader Universal Label (UL) value:

060e2b34.0205.0101.0d010201.01020400

as shown in [Example 4.5](#) item **1**. Absence of this value is cause to fail this test.

3. Examine the listing for the OperationalPattern value:

060e2b34.0401.0102.0d010201.10000000,

as shown in [Example 4.5](#) item **2**. Absence of this value is cause to fail this test.

4. Examine the listing for the Essence Container values as shown in [Example 4.5](#) item **3**. There are three valid possibilities for the data in this field:

a. If two values are present, and they are:

060e2b34.0401.0103.0d010301.027f0100 and

060e2b34.0401.0107.0d010301.020c0100,

then the file is an Image file. For more information see [Section 4.4.1.5: Essence Descriptor for JPEG 2000](#).

b. If two values are present, and they are:

060e2b34.0401.0103.0d010301.027f0100 and

060e2b34.0401.0101.0d010301.02060100,

then the file is an Sound file. For more information see [Section 4.4.1.6: Essence Descriptor for PCM Audio](#).

c. If two values are present, and they are:

060e2b34.0401.0103.0d010301.027f0100 and

060e2b34.0401.0107.0d010301.020b0100,

the Essence is ciphertext and an additional procedure, listed below, must be carried out.

Failure to meet exactly one of the valid possibilities is cause to fail this test.

5. Examine the listing and locate the EssenceContainerData set, UL value:

060e2b34.0253.0101.0d010101.01012300.

This should contain exactly one LinkedPackageUID value. Verify that there is only one SourcePackage set, UL value:

060e2b34.0253.0101.0d010101.01013700

and that the PackageUID value exactly matches the LinkedPackageUID value of the EssenceContainerData set. Failure of any of the above conditions is cause to fail this test.

6. Only for the case of Encrypted Essence, the SourcePackage set, UL value:

060e2b34.0253.0101.0d010101.01013700,

should contain a third Track UID that matches the InstanceUID value of a single StaticTrack set, UL value:

060e2b34.0253.0101.0d010101.01013a00.

The StaticTrack set should have a Sequence value that matches the InstanceUID of a Sequence set, UL

value:

060e2b34.0253.0101.0d010101.01010f00.

The found Sequence set should have a StructuralComponents value that matches the InstanceUID of a single DMSegement set, UL value:

060e2b34.0253.0101.0d010101.01014100.

The DMSegment set should have a DMFramework value that matches a single CryptographicFramework set, UL value:

060e2b34.0253.0101.0d010401.02010000.

The CryptographicFramework set should have a ContextSR value that matches the InstanceUID of a single CryptographicContext set, UL value:

060e2b34.0253.0101.0d010401.02020000.

The CryptographicContext set has a SourceEssenceContainer value, which should contain either the UL value:

060e2b34.0401.0107.0d010301.020c0100

for an Image file, or:

060e2b34.0401.0101.0d010301.02060100

for a Sound file. For more information see [Section 4.4.1.4: Encrypted Essence](#). Failure of any of the above conditions is cause to fail this test.

Supporting Materials

Reference Documents	DCI-DCSS, 5.2.2.2, 5.2.2.3, 5.2.2.4, 5.2.2.5, 5.2.2.6, 5.3.1, 5.3.2 SMPTE-377-1 SMPTE-379-1 SMPTE-382 SMPTE-422 SMPTE-429-2 SMPTE-429-3 SMPTE-429-4 SMPTE-429-6
Test Equipment	klvwalk

4.4.3. Timed Text Track File Format

Objective

- Verify that timed text essence is wrapped in files conforming to Material Exchange Format (MXF) as defined by [SMPTE-377-1] and [SMPTE-410], and further constrained by [SMPTE-379-1] and [SMPTE-429-5].
- Verify that timed text essence is encoded according to {ref-SMPTE-428-7}.
- If the Essence Container is encrypted, verify that this conforms to [SMPTE-429-6].

Procedures

1. Using the **klvwalk** software utility, produce a listing of the MXF KLV Header Metadata structure. Error free completion of the command confirms the validity of the MXF structure. Any other result is cause to fail the test.

2. Examine the listing for the MXF Partition Pack structure with a ClosedCompleteHeader Universal Label (UL) value:

060e2b34.0205.0101.0d010201.01020400

as shown in [Example 4.5](#) item **1**. Absence of this value is cause to fail this test.

3. Examine the listing for the OperationalPattern value:

060e2b34.0401.0102.0d010201.10000000,

as shown in [Example 4.5](#) item **2**. Absence of this value is cause to fail this test.

4. Examine the listing for the Essence Container values as shown in [Example 4.5](#) item **3**. There are two valid possibilities for the data in this field:

a. If two values are present, and they are:

060e2b34.0401.0103.0d010301.027f0100 and

060e2b34.0401.010a.0d010301.02130101,

then the file is a Timed Text file. For more information see [Section 4.4.1.5: Essence Descriptor for JPEG 2000](#).

b. If two values are present, and they are:

060e2b34.0401.0103.0d010301.027f0100 and

060e2b34.0401.0107.0d010301.020b0100,

the Essence is ciphertext and an additional procedure, listed below, must be carried out.

Failure to meet exactly one of the valid possibilities is cause to fail this test.

5. Examine the listing and locate the EssenceContainerData set, UL value:

060e2b34.0253.0101.0d010101.01012300.

This should contain exactly one LinkedPackageUID value. Verify that there is only one SourcePackage set, UL value:

060e2b34.0253.0101.0d010101.01013700

and that the PackageUID value exactly matches the LinkedPackageUID value of the EssenceContainerData set. Failure of any of the above conditions is cause to fail this test.

6. Only for the case of Encrypted Essence, execute sub-procedure #6 as given in [Section 4.4.2](#). In this case the SourceEssenceContainer value within the CryptographicContext set contain the UL value:

060e2b34.0401.010a.0d010301.02130101

to indicate a Timed Text file. Failure of any of the above conditions is cause to fail this test.

Supporting Materials

Reference Documents	DCI-DCSS, 3.3.4 SMPTE-428-7 SMPTE-429-5 SMPTE-429-6
Test Equipment	klvwalk

4.4.4. Track File Length

Objective

For each Track File, verify that the minimum duration is a number of frames which is greater or equal to one second of content playback at the specified edit rate. This means that each image Track File needs to contain at least 24 (at 24 fps frame rate) or 48 (at 48 fps frame rate) frames, and that each audio Track File needs to contain at least 48,000 (at 48kHz sampling rate) or 96,000 (at 96 kHz sampling rate) audio samples.

Procedures

This may be accomplished by using the **asdcptest** software utility to provide information about the file and confirming that the reported ContainerDuration value is equal or greater than the SampleRate value. Failure to meet the above conditions is cause to fail this test.

E.g.

```
$ asdcptest -i -v <input-file>
...
SampleRate: 24/1
...
ContainerDuration: 528
...
$
```

Supporting Materials

Reference Documents	DCI-DCSS, 5.3.1.3
Test Equipment	asdcptest

4.4.5. Image Track File Frame Boundary

Objective

- Image Track Files must begin and end with complete frames that allow for splicing. Verify that both the first and the last JPEG2000 image in a sequence are completely contained within the Image Track File, *i.e.*, no other Track Files are needed for complete decoding or displaying of the first and the last frame.
- Each complete Frame of Image Data must be wrapped within the KLV structure according to [SMPTE-336] and [SMPTE-422].

Procedures

1. Determine the number of frames contained in the Track File. This will be used in the next step to extract the last frame in the file. This can be achieved by using the **asdcptest** software utility, and subtracting one from the ContainerDuration value, as shown below.

```

$ asdcp-test -i -v PerfectMovie-j2c-pt.mxf
File essence type is JPEG 2000 pictures.
ProductUUID: 43059a1d-0432-4101-b83f-736815acf31d
ProductVersion: Unreleased 1.1.13
CompanyName: DCI
ProductName: asdcplib
EncryptedEssence: No
AssetUUID: 0e676fb1-951b-45c4-8334-ed2c59199815
Label Set Type: SMPTE
AspectRatio: 2048/1080
EditRate: 24/1
StoredWidth: 2048
StoredHeight: 1080
Rsize: 3
Xsize: 2048
Ysize: 1080
X0size: 0
Y0size: 0
XTsize: 2048
YTsize: 1080
XT0size: 0
YT0size: 0
ContainerDuration: 240
Color Components:
11.1.1
11.1.1
11.1.1
Default Coding (16): 01040001010503030000778888888888
Quantization Default (33): 227f187f007f007ebc76ea76ea76bc6f4c6f4c6f645803580358455fd25fd25

```

- Using the **asdcp-test** software utility, extract the first and the last frames of content from the Track File.

```

$ asdcp-test -x first -d 1 -f 0 PerfectMovie-j2c-pt.mxf
$ asdcp-test -x last -d 1 -f 239 PerfectMovie-j2c-pt.mxf
$ ls
first000000.j2c
last000239.j2c
PerfectMovie-j2c-pt.mxf

```

- Verify that the first and the last frames of content decode completely, and without errors. Failure to correctly decode either frame is cause to fail this test. This can be achieved by using JPEG 2000 decoding software. An example is shown below. (Note that the output of the **j2c-scan** program is long and has been truncated here for brevity. Please see [Section C.5](#) for a detailed example.)

```

$ j2c-scan frame000000.j2c
digital cinema profile: none
rsiz capabilities: standard
pixel offset from top-left corner: (0, 0)
tile width/height in pixels: (2048, 1080)
image width/height in tiles: (1, 1)
tile #1
coding style: 1
progression order: Component-Position-Resolution-Layer
POC marker flag: 0
number of quality layers: 1
rate for layer #1: 0.0
multi-component transform flag: 1
...

```

Supporting Materials

Reference Documents	DCI-DCSS, 5.3.3.2 SMPTE-336 SMPTE-422
Test Equipment	asdcg-test j2c-scan

4.4.6. Audio Track File Frame Boundary

Objective

The Audio Track File is required to begin and end with complete frames that are associated with its Image Track File to allow for a clean transition between reels. The audio data within the Track File shall be wrapped using KLV on an image frame boundary.

Procedures

Verify that exactly the expected number of Audio bytes are embedded within each KLV encoded triplet for each frame of the Audio Track File. This can be achieved by using the software command `klvwalk` to display the length of every WAVEssence set (UL value `060e2b34.0102.0101.0d010301.16010101`) and checking that each frame contains the appropriate number of bytes. The expected number of Audio Bytes per frame can be calculated by using the formula $len=BPS*Ch*SPF$, where BPS is the number of Bytes Per Sample (BPS=3), Ch is the number of Audio Channels in the DCP, and SPF is the number of Samples Per Frame value taken from [Table 4.2](#).

If any frame has an actual `len` that differs from the expected value, calculated from the formula, this is cause to fail this test.

The example below shows eight frames of a composition containing six channels of 48kHz samples at 24fps, completely wrapped in KLV triplets ($3 * 6 * 2000 = 36000$).

```
$klvwalk PerfectMovie-pcm-pt.mxf
...
060e2b34.0102.0101.0d010301.16010101 len: 36000 (WAVEssence)
060e2b34.0102.0101.0d010301.16010101 len: 36000 (WAVEssence)
060e2b34.0102.0101.0d010301.16010101 len: 36000 (WAVEssence)
060e2b34.0102.0101.0d010301.16010101 len: 36000 (WAVEssence)
060e2b34.0102.0101.0d010301.16010101 len: 36000 (WAVEssence)
060e2b34.0102.0101.0d010301.16010101 len: 36000 (WAVEssence)
060e2b34.0102.0101.0d010301.16010101 len: 36000 (WAVEssence)
060e2b34.0102.0101.0d010301.16010101 len: 36000 (WAVEssence)
...
```

The possible values for the Samples/Frame are shown in table below.

Table 4.2.Audio Samples Per Frame

FPS	Sample Rate	Samples/Frames
24	28 kHz	2000
24	96 kHz	4000
48	48 kHz	1000
48	96 kHz	2000

Supporting Materials

Reference Documents	DCI-DCSS, 5.3.4.2
Test Equipment	klvwalk

4.5. Essence

4.5.1. Image Structure Container and Image Container Format

Objective

- Verify that the images contained in the Track Files conform to an Image Structure Container that consists of either 4K (4096x2160) (Operational Level 1) or 2K (2048x1080) (Operational Level 2 and 3). It is expected that the image structure shall use one of the two containers such that either the horizontal or vertical resolution is filled.
- Verify that both the horizontal and vertical dimensions of the image structure container are divisible by four for Level 1, or two for Level 2 and 3 image structures. This ensures that the image can be centered correctly.
- Verify that the bit depth for each code value for a color component shall be 12 bits. This yields 36 bits per pixel.

Procedures

- Using the software command **klvwalk**, locate the RGBAEssenceDescriptor set and record the StoredWidth, StoredHeight, and AspectRatio values within. The failure to meet any of the following conditions is cause to fail this test:
 - a. Verify that the first number (numerator) of the AspectRatio field is the same as the StoredWidth value.
 - b. Verify that the second number (denominator) of the AspectRatio field is the same as the StoredHeight value.
 - c. Verify that exactly one of the StoredWidth or StoredHeight values are equal to the Maximum Horizontal Pixels or Maximum Vertical Pixels values from [Table 4.3](#).
 - d. Verify that both the StoredWidth and StoredHeight values are equal to, or less than, the Maximum Horizontal Pixels or Maximum Vertical Pixels values, respectively, from [Table 4.3](#).
 - e. Verify that both the StoredWidth and StoredHeight values are exactly divisible by two for a 2K file, and four for a 4K file.

An example of the RGBAEssenceDescriptor set is shown below:

```

$ klvwalk -r PerfectMovie-j2c-pt.mxf
...
060e2b34.0253.0101.0d010101.01012900 len: 169 (RGBAEssenceDescriptor)
InstanceUID = 82141918-celb-47a5-ac13-c47cfb2e51a7
GenerationUID = 00000000-0000-0000-0000-000000000000
Locators:
SubDescriptors:
92e96e5e-6bef-4985-8117-7dfa541f96fa
LinkedTrackID = 2
SampleRate = 24/1
ContainerDuration = 240
EssenceContainer = 060e2b34.0401.0107.0d010301.020c0100
Codec = 060e2b34.0401.0109.04010202.03010103
FrameLayout = 0
StoredWidth = 2048
StoredHeight = 1080
AspectRatio = 2048/1080
ComponentMaxRef = 4095
ComponentMinRef = 0
...

```

The valid Image Structure Container values are shown in table below.

Table 4.3. Image Structure Operational Levels

Operational level	Maximum Horizontal Pixels	Maximum Vertical Pixels	Frames per Second
1	4096	2160	24
2	2048	1080	48
3	2048	1080	24

- Using the software commands **asdcp-test** and **j2c-scan**, extract an image frame from the file and verify that the bit depth for each component is 12 bits. A component bit-depth value other than 12 shall be cause to fail this test.

An example of this operation is shown below:

```

$ asdcp-test -d 1 -x frame j2c/PerfectMovie-j2c-pt.mxf
$ j2c-scan frame_000001.j2c
coding parameters
digital cinema profile: none
rsiz capabilities: standard
pixel offset from top-left corner: (0, 0)
tile width/height in pixels: (2048, 1080)
image width/height in tiles: (1, 1)
...

```

Supporting Materials

Reference Documents	DCI-DCSS, 3.2.1.2, 3.2.1.3, 3.2.1.7 SMPTE-428-1
Test Equipment	klvwalk asdcp-test j2c-scan

4.5.2. Image Compression Standard & Encoding Parameters

Objective

Verify that the image encoding parameters in a Picture Track File conform to [SMPTE-429-4].

Procedures

1. Verify that the UL value in the PictureEssenceCodingfield of the MXF RGBAEssenceDescriptor (see **6** in Example 4.8) is one of:

060e2b34.0401.0109.04010202.03010103 (for 2K images) or

060e2b34.0401.0109.04010202.03010104 (for 4K images).

If the UL value does not match one of those listed above, or is the wrong value for the contained essence, this is cause to fail the test.

2. Using a software command such as **asdcptest**, extract all the frames in the Track File to a directory. An example is shown below.

```
$ asdcptest -x frame j2c/PerfectMovie-j2c-pt.mxf
$ ls j2c
frame000000.j2c frame000057.j2c frame000124.j2c frame000191.j2c
frame000001.j2c frame000058.j2c frame000125.j2c frame000192.j2c
frame000002.j2c frame000059.j2c frame000126.j2c frame000192.j2c
frame000003.j2c frame000060.j2c frame000127.j2c frame000194.j2c
...
```

3. Verify that every frame is correctly JPEG 2000 encoded as described in [ISO-15444-1]. Verify that the proper JPEG 2000 encoding parameters as specified in [ISO-15444-1-AMD-1] were used. The Codestream Specifications for 2K and 4K distributions are listed in [DCI-DCSS], section 4.4. This can be achieved by using JPEG 2000 decoding software. An example is shown below. (Note that the output of the **j2c-scan** program is long and has been truncated here for brevity. Please see [Section C.5](#) for a detailed example.) If any frame fails to correctly decode or does not conform to the appropriate Codestream Specifications, this is cause to fail the test.

```
$ j2c-scan frame000000.j2c
digital cinema profile: none
rsiz capabilities: standard
pixel offset from top-left corner: (0, 0)
tile width/height in pixels: (2048, 1080)
image width/height in tiles: (1, 1)
tile #1
coding style: 1
progression order: Component-Position-Resolution-Layer
POC marker flag: 0
number of quality layers: 1
rate for layer #1: 0.0
multi-component transform flag: 1
...
```

Supporting Materials

Reference Documents	
	DCI-DCSS, 3.2.1.5, 4.2, 4.4
	ISO-15444-1

Test Equipment	ISO-15444-1-AMD-1
	SMPTE-429-4
	asdcptest
	OpenJPEG

4.5.3. Audio Characteristics

Objective

Sound Track Files shall conform to the specifications given in [SMPTE-428-2] and [SMPTE-428-3], and be constrained as specified in [SMPTE-429-2]. A Sound Track File shall contain linear PCM audio sampled at 48000 or 96000 samples per second, 24 bits per sample. The file shall contain no more than 16 channels of audio.

Procedures

Using the software command **klvwalk**, locate the WaveAudioDescriptor set which starts with the Universal Label (UL) of 060e2b34.0253.0101.0d010101.01014800. An example is shown below.

```
$ klvwalk -r PerfectMovie-pcm-pt.mxf
...
060e2b34.0253.0101.0d010101.01014800 len: 134 (WaveAudioDescriptor)
InstanceUID = e1c4c755-2c3e-4274-a3bf-581aadd63a4b
GenerationUID = 00000000-0000-0000-0000-000000000000
Locators:
SubDescriptors:
LinkedTrackID = 2
SampleRate = 24/1
ContainerDuration = 480
EssenceContainer = 060e2b34.0401.0101.0d010301.02060100
Codec = 00000000.0000.0000.00000000.00000000
AudioSamplingRate = 48000/1
Locked = 0
AudioRefLevel = 0
ChannelCount = 6
QuantizationBits = 24
DialNorm = 0
BlockAlign = 18
SequenceOffset = 0
AvgBps = 144000
...
```

Verify the following:

1. The EssenceContainer field has a value of 060e2b34.0401.0101.0d010301.02060100. Any other value is cause to fail this test.
2. The ChannelAssignment field is not present, or, if present, has a value from the set of UL values defined in [SMPTE-429-2], [Appendix A](#), "Audio Channel Assignment Label". Any other value in the ChannelAssignment field is cause to fail this test.
3. The AudioSamplingRate field has a value of either 48000/1 or 96000/1. Any deviation from these values is cause to fail this test.
4. The ChannelCount field has a value of no fewer than six (6) and no greater than sixteen (16). Any deviation from these values is cause to fail this test.

5. The QuantizationBits field has a value of 24. Any other value is cause to fail this test.
6. The BlockAlign field is exactly the value of ChannelCount * 3. Any other value is cause to fail this test.
7. The AvgBps field is exactly the value of the AudioSamplingRate * ChannelCount * 3. Any other value is cause to fail this test.

Supporting Materials

Reference Documents	DCI-DCSS, 3.3.2.2, 3.3.4.1 SMPTE-428-2 SMPTE-428-3 SMPTE-429-2
Test Equipment	klvwalk

4.5.4. Timed Text Resource Encoding

Objective

- Verify that timed text descriptions in XML conform to [SMPTE-428-7].
- Verify that font resources conform to [ISO-144496].
- Verify that sub-picture resources conform to [ISO-15948].

Procedures

1. Extract the Timed Text Resource and any Ancillary Resources from the Track File.
2. Verify that the Timed Text Resource is an XML document that can be validated using the schema from [SMPTE-428-7]. If the XML validation produces errors, this is cause to fail this test.

```
$ schema-check testfile.xml S428-7-2007.xsd
$
```

3. Verify that any font resources are valid according to [ISO-144496]. If the font validation produces errors, this is cause to fail this test.

```
$ ftlint 1 font_file.otf
font_file.otf: OK.
$
```

4. Verify that any subpicture resources are valid according to [ISO-15948]. The subpicture must be of PNG format, decode without errors, and the size (geometry) must be smaller than, or equal to, that of the main picture. If the png file causes **identify** to report errors, or if the geometry of the PNG is greater than that of the main picture, this is cause to fail this test.

```
$ identify -verbose subpicture_0001.png
Image: subpicture_0001.png
Format: PNG (Portable Network Graphics)
Geometry: 120x420
Class: DirectClass
Colorspace: RGB
Type: GrayscaleMatte
Depth: 8 bits
...
```

Supporting Materials

Reference Documents	DCI-DCSS, 3.4.2.2, 4.4.3.2, 3.4.3.4 ISO-144496 ISO-15948 SMPTE-428-7
Test Equipment	schema-check ftlint identify

4.6. Digital Cinema Package

4.6.1. DCP Integrity

Objective

- Verify that the Volume Asset Map is present, correctly formatted, and correctly located in the filesystem.
- Verify that for all the Packing Lists found in the Asset Map file, all of the assets referenced in each Packing List are present and are valid (*i.e.*, each Referenced Asset's file size and Message Digest are correct).
File Integrity will be guaranteed by applying the SHA-1 hashing algorithm [RFC-3174] to each asset included in the DCP. The resulting message digest is Base64 encoded and included in the Packing List file.
- Verify that for all the Composition Playlists found in each Packing List, the Referenced Assets exist in the Packing List file.

Procedures

1. Validate the Format of the Volume Asset Map file by executing the test procedure [Section 4.1.1: Asset Map File](#).
2. Validate the Format of the Volume Index file by executing the test procedure [Section 4.1.2: Volume Index File](#).
3. Validate the Format of each Packing List file by executing the test procedure [Section 4.2.1: Packing List File](#).
4. Validate the Signature of each Packing List file by executing the test procedure [Section 4.2.2: Packing List Signature Validation](#).

5. For each Packing List file (e.g. PerfectMovie.pkl.xml) in the Asset Map:

a. Open the Packing List and for each Asset Id contained within:

- i. Locate the Referenced Asset in the filesystem and compare its file size with the value listed in the <Size> element of the <Asset> element. Inconsistency is cause to fail this test.
- ii. Calculate the Message Digest of the Referenced Asset and encode the result in Base64. Compare the result with the value listed in the <Hash> element of the <Asset>element. Inconsistency is cause to fail this test. The following is an example using the **asdcptest** software utility:

```
$ asdcptest -t PerfectMovie-j2c-pt.mxf  
t0MirEH0VFF4Mi1IP0iYVjrvb14= PerfectMovie-j2c-pt.mxf
```

6. Validate the Format of each Composition Playlist file by executing the test procedure [Section 4.3.1: Composition Playlist File](#).

7. Validate the Signature of each Composition Playlist file by executing the test procedure [Section 4.3.2: Composition Playlist Signature Validation](#).

8. For each Composition Playlist (e.g. PerfectMovie.cpl.xml) in the Asset Map:

a. Open the Composition Playlist and for each Asset Id contained within:

- i. Locate the Asset Id in the Packing List file. Any missing Asset Ids are cause to fail this test.

Supporting Materials

Reference Documents	DCI-DCSS, 5.2.2.6, 5.3.1.9, 5.5.2.3, 5.5.3.2, 9.7.5 PKCS-1 RFC-3174 SMPTE-429-8
Test Equipment	asdcptest

Chapter 5. Common Security Features

This chapter contains test procedures of security features that apply to more than one type of device. Procedures are given for Type 1 and Type 2 Secure Processing Block (SPB) physical security requirements, Intra-theater communications, and security log reporting.

5.1. SPB Security Features

The test procedures in this section apply to any device or component that is classified as a Type 1 or Type 2 SPB.

5.1.1. SPB Digital Certificate

Objective

This following applies only if the Test Subject is an SPB

- Verify that the Test Subject carries the correct number of leaf certificates.
- Verify that the leaf certificates conform to [SMPTE-430-2] and Section 9.5.1 of [DCI-DCSS].
- Verify that the roles contained in the Common Name field of the Test Subject certificate(s) accurately reflect the security functions of the Test Subject.
- Verify that the exterior surface of the device containing the Test Subject is labeled with information traceable to the Common Name of the Test Subject.

Procedures

If the Test Subject is a Media Block:

1. Obtain the Test Subject leaf certificates from the manufacturer, and using manufacturer-supplied documentation, compile the list of expected role identifiers corresponding to the security functions of the Test Subject -- see [SMPTE-430-2], and Section 9.5.1 of [DCI-DCSS] for lists of roles.
2. Verify that exactly three leaf certificates are presented.
3. Verify that each leaf certificate has a distinct Subject DnQualifier value.
4. Verify that each row of Table 5.1 is matched by exactly one of the leaf certificates.
5. For each leaf certificate, verify that each role listed in the Subject Common Name field corresponds to a security function implemented by the Test Subject.
6. For each leaf certificate, verify that the Subject Common Name field contains the serial number of the Test Subject. Additional identifying information may be present.
7. For each leaf certificate, verify that information identifying the make and model of the Test Subject is carried in the Subject field. Additional identifying information may be present.
8. For each leaf certificate, verify that either the make, model and serial number of the Test Subject, or information that is unambiguously traceable by the manufacturer to the Subject field of all certificates, is clearly placed on the exterior of the device containing the Test Subject.
9. Failure to verify any of the conditions above is cause to fail this test.

Table 5.1. Media Block Leaf Certificate Criteria

Roles listed in the Subject Common Name	DigitalSignature flag	KeyEncipherment flag
---	-----------------------	----------------------

includes the SM and MIC roles, but does not include any of the LS and RES roles	false	true
includes the SM, MIC and RES roles, but does not include the LS role	false	true
includes LS role	true	false

For any other Test Subject:

1. Obtain the Test Subject leaf certificates from the manufacturer, and using manufacturer-supplied documentation, compile the list of expected role identifiers corresponding to the security functions of the Test Subject -- see [SMPTE-430-2], and Section 9.5.1 of [DCI-DCSS] for lists of roles.
2. Verify that exactly one leaf certificate is presented.
3. Verify that the Subject Common Name of the leaf certificate presented includes at least one the role combinations listed in Section 9.5.1.1 of [DCI-DCSS] and does not contain any of the role combination listed in Sections 9.5.1.2 and 9.5.1.3 of [DCI-DCSS].
4. Verify that each role listed in the Subject Common Name field of the leaf certificate corresponds to a security function implemented by the Test Subject.
5. Verify that the Subject Common Name field of the leaf certificate collected contains the serial number of the Test Subject. Additional identifying information may be present.
6. Verify that information identifying the make and model of the Test Subject is carried in the Subject field of the leaf certificate. Additional identifying information may be present.
7. Verify that either the make, model and serial number of the Test Subject, or information that is unambiguously traceable by the manufacturer to the Subject field of the leaf certificate, is clearly placed on the exterior of the device containing the Test Subject.
8. Failure to verify any of the conditions above is cause to fail this test.

Supporting Materials

Reference Documents	DCI-DCSS, 9.5.1, 9.5.1.1, 9.5.1.2, 9.5.1.3 SMPTE-430-2
----------------------------	---

Consolidated Test Sequences

Sequence	Type	Measured Data
15.2. Integrated IMB Test Sequence	Pass/Fail	—
15.4. Integrated IMB Confidence Sequence	Pass/Fail	—
20.2. OMB Test Sequence	Pass/Fail	—
21.2. Integrated IMBO Test Sequence	Pass/Fail	—
20.4. OMB Confidence Sequence	Pass/Fail	—
21.4. Integrated IMBO Confidence Sequence	Pass/Fail	—

24.4. SDR Projector Confidence Sequence	Pass/Fail	—
26.2. HDR Direct View Display Test Sequence	Pass/Fail	—
26.4. HDR Direct View Display Confidence Sequence	Pass/Fail	—
27.2. SDR Direct View Display Test Sequence	Pass/Fail	—
27.4. SDR Direct View Display Confidence Sequence	Pass/Fail	—
28.2. HDR Projector Test Sequence	Pass/Fail	—
28.4. HDR Projector Confidence Sequence	Pass/Fail	—

5.1.2. Deleted Section

The section "SPB Type 2 Security Perimeter" was deleted. The section number is maintained here to preserve the numbering of subsequent sections.

5.1.3. Deleted Section

The section "SPB Type 2 Secure Silicon" was deleted. The section number is maintained here to preserve the numbering of subsequent sections.

5.2. Intra-Theater Communication

5.2.1. Deleted Section

The section "TLS Session Initiation" was deleted. The section number is maintained here to preserve the numbering of subsequent sections.

5.2.2. Auditorium Security Messages

5.2.2.1. Deleted Section

The section "Auditorium Security Message Support" was deleted. The section number is maintained here to preserve the numbering of subsequent sections.

5.2.2.2. Deleted Section

The section "ASM Failure Behavior" was deleted. The section number is maintained here to preserve the numbering of subsequent sections.

5.2.2.3. Deleted Section

The section "ASM 'RRP Invalid'" was deleted. The section number is maintained here to preserve the numbering of subsequent sections.

5.2.2.4. Deleted Section

The section "ASM 'GetTime'" was deleted. The section number is maintained here to preserve the numbering of subsequent sections.

5.2.2.5. Deleted Section

The section "ASM 'GetEventList'" was deleted. The section number is maintained here to preserve the numbering of subsequent sections.

5.2.2.6. Deleted Section

The section "ASM 'GetEventID'" was deleted. The section number is maintained here to preserve the numbering of subsequent sections.

5.2.2.7. Deleted Section

The section "ASM 'LEKeyLoad'" was deleted. The section number is maintained here to preserve the numbering of subsequent sections.

5.2.2.8. Deleted Section

The section "ASM 'LEKeyQueryID'" was deleted. The section number is maintained here to preserve the numbering of subsequent sections.

5.2.2.9. Deleted Section

The section "ASM 'LEKeyQueryAll'" was deleted. The section number is maintained here to preserve the numbering of subsequent sections.

5.2.2.10. Deleted Section

The section "ASM 'LEKeyPurgeID'" was deleted. The section number is maintained here to preserve the numbering of subsequent sections.

5.2.2.11. Deleted Section

The section "ASM 'LEKeyPurgeAll'" was deleted. The section number is maintained here to preserve the numbering of subsequent sections.

5.2.2.12. Deleted Section

The section "ASM 'GetProjCert'" was deleted. The section number is maintained here to preserve the numbering of subsequent sections.

5.2.3. Deleted Section

The section "TLS Exception Logging" was deleted. The section number is maintained here to preserve the numbering of subsequent sections.

5.3. Event Logs

Secure Processing Block (SPB) modules are required to provide event log reports on demand. The log reports are XML documents (see [Section 3.1](#)) having a structure defined by [SMPTE-430-4]. This section will describe the report format and present procedures for testing general operational requirements for event logging.

Note:

The method of generating a log report will vary between implementations. Consult the manufacturer's documentation for log report generation instructions.

5.3.1. Log Report Format

Standard d-cinema log reports are encoded as XML documents per [SMPTE-430-4]. The reports consist of a preamble, which identifies the device that created the report, and a sequence of log records. In log reports which contain security events (Security Event Logs), some of the log records may contain XML Signature elements. The report format includes many unique security features; the reader should study [SMPTE-430-4] in detail to understand how log authentication works.

The following subsections detail the major features of a log report

5.3.1.1. Log Report

A collection of one or more log records is presented as an XML document having a single LogReport element as the top-level element. The log report begins with reportDate and reportingDevice elements. The contents of the elements identify the time the log was created and the device that created the log

```
<?xml version="1.0" encoding="UTF-8"?>
<LogReport ❶
  xmlns="http://www.smpte-ra.org/schemas/430-4/2008/LogRecord/" ❷
  xmlns:dcml="http://www.smpte-ra.org/schemas/433/2008/dcmlTypes/">
  <reportDate>2007-05-04T09:30:47-08:00</reportDate> ❸
  <reportingDevice> ❹
    <dcml:DeviceIdentifier idtype="CertThumbprint">YmVsc3dpY2tAZW50ZXJ0ZWNoLmNvbQ==
    </dcml:DeviceIdentifier>
    <dcml:DeviceTypeID scope="http://www.smpte-ra.org/schemas/433/2008/dcmlTypes#DeviceTypeTokens">SM
    </dcml:DeviceTypeID>
    <dcml:AdditionalID>vnqteTcB2Gji\+1Hl23sxxg0qvwE=</dcml:AdditionalID> ❺
    <dcml:DeviceSerial>000000042</dcml:DeviceSerial> ❻
    <dcml:ManufacturerCertID>rlpve6MSncWouNIpFcTSIhk6w2A=</dcml:ManufacturerCertID> ❼
    <dcml:DeviceCertID>9czqa+0orIADHDIYxAkn/IcmZ3o=</dcml:DeviceCertID>
    <dcml:ManufacturerName>Acme Digital Cinema Inc.</dcml:ManufacturerName>
    <dcml:DeviceName>Mojo Media Block</dcml:DeviceName>
    <dcml:ModelNumber>MB-3000</dcml:ModelNumber>
    <dcml:VersionInfo>
      <dcml:Name>Bootloader</dcml:Name>
      <dcml:Value>1.0.0.0</dcml:Value>
      <dcml:Name>Security Module</dcml:Name>
      <dcml:Value>3.4.2.1</dcml:Value>
    </dcml:VersionInfo>
  </reportingDevice>
```

- ❶ The LogReport element is the root element of a log report document.
- ❷ The LogRecord and DCML namespaces are used
- ❸ This value gives the date on which this report document was generated
- ❹ This structure identifies the device that generated this report
- ❺ For log reports generated by an SM that implements dual certificates (see Section 9.5.1.2 at [DCI-DCSS]), the AdditionalID element is present and contains a thumbprint of the SM Log Signer digital certificate
- ❻ The serial number of reporting device
- ❼ The certificate thumbprint (per [SMPTE-430-2]) of the reporting device

Example 5.1. Log Report Example

5.3.1.2. Log Record

Each event contained in the log report is encoded as a LogRecordElement element. This element type has three major sub-elements: LogRecordHeader, LogRecordBody, and LogRecordSignature. The first two are shown in the example below, the last is the subject of the next section.

Note:

The log record element defined in [SMPTE-430-4] is known by two names. The correct name to use depends on context. Testing a candidate document against the LogRecord schema will verify correct use. When a log record (defined as the complex type logRecordType in the LogRecord schema) appears as a sub-element of a LogReport element, the record element name is LogRecordElement. When a log record appears as the root element of an XML document, the record element name is LogRecord.

```

<LogRecordElement 1
  xmlns="http://www.smpte-ra.org/schemas/430-4/2008/LogRecord/"
  xmlns:dcmL="http://www.smpte-ra.org/schemas/433/2008/dcmLTypes/"
  <LogRecordHeader>
    <EventID>urn:uuid:8a221dfc-f5c6-426d-a2b8-9f6ff1cc6e31</EventID> 2
    <TimeStamp>2005-12-17T10:45:00-05:00</TimeStamp> 3
    <EventSequence>1000003</EventSequence> 4
    <DeviceSourceID>
      <dcmL:PrimaryID idtype="CertThumbprint">kkqiVpDUAggQDHyHz0x9cDcsseU=</dcmL:PrimaryID>
    </DeviceSourceID>
    <EventClass>http://www.smpte-ra.org/430.5/2007/SecurityLog</EventClass> 5
    <EventType scope="http://www.smpte-ra.org/430.5/2007/SecurityLog/#EventTypes">Key</EventType> 6
    <contentID>urn:uuid:733365c3-2d44-4f93-accd-43cb39b0cedf</contentID> 7
    <previousHeaderHash>9czqa+0orIADHDIYxAkn/IcmZ3o=</previousHeaderHash> 8
    <recordBodyHash>9czqa+0orIADHDIYxAkn/IcmZ3o=</recordBodyHash> 9
  </LogRecordHeader>
  <LogRecordBody>
    <EventID>urn:uuid:8a221dfc-f5c6-426d-a2b8-9f6ff1cc6e31</EventID>
    <EventSubType scope="http://www.smpte-ra.org/430.5/2007/SecurityLog/#EventSubTypes-key">
      KDMKeysReceived
    </EventSubType> 10
    <Parameters> 11
      <dcmL:Parameter>
        <dcmL:Name>SignerID</dcmL:Name>
        <dcmL:Value xsi:type="ds:DigestValueType">rlpve6MSncWouNIpFCTSIhk6w2A=</dcmL:Value>
      </dcmL:Parameter>
    </Parameters>
    <Exceptions> 12
      <dcmL:Parameter>
        <dcmL:Name>KDMFormatError</dcmL:Name>
        <dcmL:Value xsi:type="xs:string">XML validation failed on line 36</dcmL:Value>
      </dcmL:Parameter>
    </Exceptions>
    <ReferencedIDs> 13
      <ReferencedID>
        <IDName>CompositionID</IDName>
        <IDValue>urn:uuid:64bb6972-13a0-1348-a5e3-ae45420ea57d</IDValue>
      </ReferencedID>
      <ReferencedID>
        <IDName>KeyDeliveryMessageID</IDName>
        <IDValue>urn:uuid:64bb6972-13a0-1348-a5e3-ae45420ea57d</IDValue>
      </ReferencedID>
    </ReferencedIDs>
  </LogRecordBody>
</LogRecordElement>

```

- 1** The LogRecordElement element contains a single log record, corresponding to a single system event. If the log record is the root element of an XML document, the element name will be LogRecord.
- 2** A UUID value that uniquely identifies this event. This ID must be the same wherever this event appears (*i.e.*, if the event appears in more than one report, the ID will be the same.)
- 3** The time and date at which the event occurred.
- 4** The sequence number of this event in the report. This element should not be used in a stand-alone LogRecord element.
- 5** The event *Class* (*e.g.*, Security.)
- 6** The event *Type* (*e.g.*, Key.)
- 7** Gives the UUID most closely associated with the content element that was being handled when the event occurred. This element should not be used in a stand-alone LogRecord element
- 8** The SHA-1 message digest of the Header element in the record that preceded this one in the report. This element should not be used in a stand-alone LogRecord element
- 9** The SHA-1 message digest of the Body element contained within the same parent LogRecordElement or LogRecord element
- 10** Describes the event *Sub-type* (*e.g.*, KDMKeysReceived.)

- 11 A list of parameters which augment the event sub-type.
- 12 If an exception (an error) occurred during the procedure that generated the event, this element will contain a list of tokens which describe the error.
- 13 A list of important identifiers that existed in the procedure context when the event occurred.

Example 5.2. Log Report Record Example

5.3.1.3. Log Record Signature

An XML Signature is used to create a tamper-proof encoding. The signature is made over the contents of the RecordAuthData element as shown in the following example. The RecordAuthData element contains the digest of the containing record's LogRecordHeader element. Consult [SMPT-430-4] for details on extending the signature's proof of authenticity to preceding records via the contents of the header's previousHeaderHash element.

```

<LogRecordSignature> 1
  <HeaderPlacement>stop</HeaderPlacement>
  <SequenceLength>2</SequenceLength>
  <RecordAuthData Id="ID_RecordAuthData"> 2
    <RecordHeaderHash>SG93IE1hbnkgTW9yZSBSZlVbnM</RecordHeaderHash> 3
    <SignerCertInfo> 4
      <ds:X509IssuerName>CN=DistCo-ca,OU=DistCo-ra,O=DistCo-ra,
        dnQualifier=vnqteTcB2Gji\+1HL23sxxg0qvwE=</ds:X509IssuerName>
      <ds:X509SerialNumber>16580</ds:X509SerialNumber>
    </SignerCertInfo>
  </RecordAuthData>
  <Signature> 5
    <ds:SignedInfo>
      <ds:CanonicalizationMethod Algorithm="http://www.w3.org/TR/2001/REC-xml-c14n-20010315" />
      <ds:SignatureMethod Algorithm="http://www.w3.org/2000/09/xmldsig#rsa-sha256" />
      <ds:Reference URI="#ID_RecordAuthData">
        <ds:DigestMethod Algorithm="http://www.w3.org/2000/09/xmldsig#sha1" />
        <ds:DigestValue>VGhpcyBvbmx5IHRvb2sgdHdvIHllYXJz</ds:DigestValue>
      </ds:Reference>
    </ds:SignedInfo>
    <ds:SignatureValue>
      Vqe6MS0pHovkfqhHlkt/NNEI1GGchCW/Eyqx0ccSenuzNQc63qL+VIQoIJCcwgne0i/w/8bIgjfb
      Prs0W5M3z1R0eAZc7tt6f7q50taNmC+02wfATVXqEE8KC32q0//NQHu0L6bLLH+12oqgR5fS/mlI
      /wPn8s/pAtGA9lAXDRp03EV0vzWq0m9Ajz0xIbgzGg6AIY0airJ1gecT1qccb1zGQjB81pr3ctlp
      ECchubtSCqh+frRn4CZc4ZRLHjnx/zwHIG4EximCEKbwaz7DwN8z1yoPUzut9ik7X0EYfRlV
      F3piQoLeeFcFrkfnWYyyhTX8iHT04Cz8YfGNyw==</ds:SignatureValue>
    <ds:KeyInfo>
      <ds:X509Data>
        <ds:X509IssuerSerial>
          <ds:X509IssuerName>Sample Issuer Name</ds:X509IssuerName>
          <ds:X509SerialNumber>1234567</ds:X509SerialNumber>
        </ds:X509IssuerSerial>
        <!-- X509 certificate value as block of Base64 encoded characters, -->
        <!-- truncated for brevity -->
        <ds:X509Certificate>
          QSBZDZlJ0aWZpY2F0ZSBSb3VsZCBiZSBSb25nZXIgdGhhbiB0aGlz</ds:X509Certificate>
        </ds:X509Data>
        <ds:X509Data>
          <ds:X509IssuerSerial>
            <ds:X509IssuerName>Sample Issuer Name 2</ds:X509IssuerName>
          </ds:X509IssuerSerial>
          <!-- X509 certificate value as block of Base64 encoded characters, -->
          <!-- truncated for brevity -->
          <ds:X509Certificate>TG9uZ2VyIHRobW4gdGhpcyB0b28sIGZvciBzdXJl</ds:X509Certificate>
        </ds:X509Data>
      </ds:KeyInfo>
    </Signature>
  </LogRecordSignature>

```

- ❶ The LogRecordSignature contains the signature of a log record.
- ❷ The RecordAuthData element is the content that is actually signed for the signature. This element is identified for the signature processor by the Id attribute value
- ❸ A message digest value calculated over the sibling Header element.
- ❹ This information identifies the creator of the XML Signature (the document's signer.)
- ❺ A standard XML Signature element.

Example 5.3. Log Report Signature Example

5.3.1.4. Log Report Signature Validation

XML Signatures on log reports can be checked using the procedure in [Section 3.1.3](#).

5.3.1.5. Deleted Section

The section "Log Record Proxy" was deleted. The section number is maintained here to preserve the numbering of subsequent sections.

5.3.2. Event Log Operations

5.3.2.1. Log Structure

Objective

Verify that that the Log Report retrieved from a security manager (SM):

- is an XML document and that it validates against the XML schemas defined with [SMPTE-430-4] and [SMPTE-433].
- contains urn:uuid values as specified in [RFC-4122].

Procedures

1. Set up and play a show using the following composition:
 - *DCI 2K StEM (OBAE) (Encrypted)* keyed with *KDM for 2K StEM (Encrypted) (OBAE)*, if the Test Subject is an OMB; or
 - *DCI 2K StEM (Encrypted)* keyed with *KDM for 2K StEM (Encrypted)*, otherwise.
2. Extract a security log report from the Test Subject that includes the range of time during which the above steps were carried out.
3. Using the **schema-check** software utility, validate the XML file structure against the XML schemas in [SMPTE-430-4] and [SMPTE-433]. Failure to correctly validate is cause to fail this test. For more information on schema validation see [Section 3.1.2: XML Schema](#).

```
$ schema-check <input-file> smpte-433.xsd smpte-430-4.xsd  
schema validation successful
```

4. Supply the filename of the Log Report file as an argument to the **uuid_check.py** software utility. Examine the output for error messages that identify expected UUID values that do not conform to the format specified in

[RFC-4122]. One or more occurrences is cause to fail this test, unless the non-conforming value is derived from an external source (*i.e.*, a DCP or KDM). Examples of fields that record external values are the parameters "KeyDeliveryMessageID", "CompositionID" and "TrackFileID", and the header element "contentId".

```
$ uuid_check.py <input-file>
all UUIDs conform to RFC-4122
$
```

Supporting Materials

Reference Documents	DCI-DCSS, 9.4.6.3.2 RFC-4122 SMPTE-430-4 SMPTE-433
Test Equipment	schema-check uuid_check.py
Test Materials	<i>DCI 2K StEM (Encrypted)</i> <i>KDM for 2K StEM (Encrypted)</i> <i>DCI 2K StEM (OBAE) (Encrypted)</i> <i>KDM for 2K StEM (Encrypted) (OBAE)</i>

Consolidated Test Sequences

Sequence	Type	Measured Data
15.2. Integrated IMB Test Sequence	Pass/Fail	—
20.2. OMB Test Sequence	Pass/Fail	—
21.2. Integrated IMBO Test Sequence	Pass/Fail	—

5.3.2.2. Deleted Section

The section "Log Records for Multiple Remote SPBs" was deleted. The section number is maintained here to preserve the numbering of subsequent sections.

5.3.2.3. Log Sequence Numbers

Objective

Verify that the security manager (SM) maintains a secure and persistent counter to provide a unique sequential EventSequence number to each log record it creates. Verify that this EventSequence number appears in the Header node of each log record in a report.

Procedures

1. Set up and play a show using the composition *DCI 2K StEM (Encrypted)*, keyed with *KDM for 2K StEM (Encrypted)*.
2. Extract a security log report from the Test Subject that includes the range of time during which the above steps were carried out.

3. Examine the log report using a **Text Editor**. Verify that the header in each record contains an EventSequence value that is one greater than the value in the previous record.
4. Failure to correctly sequence log records in a report shall be cause to fail this test.

Supporting Materials

Reference Documents	DCI-DCSS, 9.4.6.3.1, 9.4.6.3.4 SMPTE-430-4 SMPTE-430-5
Test Equipment	Text Editor
Test Materials	<i>DCI 2K StEM (Encrypted)</i> <i>KDM for 2K StEM (Encrypted)</i>

Consolidated Test Sequences

Sequence	Type	Measured Data
15.2. Integrated IMB Test Sequence	Pass/Fail	—
21.2. Integrated IMBO Test Sequence	Pass/Fail	—

5.3.2.4. Deleted Section

The section "Log Collection by the SM" was deleted. The section number is maintained here to preserve the numbering of subsequent sections.

5.3.2.5. Deleted Section

The section "General Log System Failure" was deleted. The section number is maintained here to preserve the numbering of subsequent sections.

5.3.2.6. Log Report Signature Validity

Objective

Verify that the Test Subject provides log event information in the form of Log Reports

Verify that all Log Records within a Log Report are properly authenticated as specified in [SMPTE-430-4] and [SMPTE-430-5].

Verify that the Log Report is signed by the SM.

Verify that EventID for a given event is maintained across collections.

Procedures

Note:

The CPLStart and CPLend records are triggered by the first and last edit unit, respectively, of the CPL reproduced by the Test Subject. For example, in the case of an OMB with OBAE capability, the first and last edit units of the CPL

are OBAE edit units, since picture edit units are not reproduced despite Main Picture assets being present in the CPL received by the OMB.

If the Test Subject uses a single certificate implementation as defined in Section 9.5.1.1.1 of [DCI-DCSS]:

1. Set up and play a show using the composition *DCI 2K Sync Test (Encrypted)*, keyed with *KDM for DCI 2K Sync Test (Encrypted)*.
2. Extract a Log Report from the Test Subject covering the time period during which Step 1 was performed.
3. Leave the system idle for no less than 1 minute, then extract a second security Log Report from the Test Subject covering the time period during which Step 1 was performed.
4. Using a **Text Editor**, locate in each of the Log Reports extracted in Steps 2 and 3 the `CPLstart` record. Failure for the records in the two reports to have the same `EventID` value is cause to fail this test. *Note: The following steps shall use the Log Report extracted in Step 2.*
5. Using a **Text Editor**, verify that the root element of the Log Report is `LogReport`. Failure of this verification is cause to fail the test.
6. Using a **Text Editor**, identify all individually signed Log Records and sequences of Log Records, as defined in [SMPTE-430-5]. Failure for any Log Record to either be signed individually or be part of a sequence is cause to fail this test.
7. Authenticate each individually signed Log Record identified in Step 4 as specified in [SMPTE-430-4] and [SMPTE-430-5], including:
 - a. Validating the `recordBodyHash` elements as specified in Section 6.1.1.5 of [SMPTE-430-5]; and
 - b. Validating the `LogRecordSignature` element as specified in Section 7.3 of [SMPTE-430-4] and Section 6.1.3 of [SMPTE-430-5].

Failure to authenticate any individually signed Log Record is cause to fail the test.

8. Authenticate each sequence of Log Records identified in Step 4 as specified in Section 9 of [SMPTE-430-4], including:
 - a. Validating the `previousHeaderHash` (unless the Log Record is the first of a sequence) and `recordBodyHash` elements as specified in Section 6.1.1.5 of [SMPTE-430-5];
 - b. Validating the authenticated chain as specified in Section 9 of [SMPTE-430-4]; and
 - c. Validating the `LogRecordSignature` element as specified in Section 7.3 of [SMPTE-430-4] and Section 6.1.3 of [SMPTE-430-5].

Failure to authenticate any sequence of Log Records is cause to fail the test.

9. Using a **Text Editor**, locate one LogRecordSignature element. Using its X509IssuerName and X509SerialNumber from the SignerCertInfo element, locate elements that match in one of the KeyInfo elements and extract the device certificate from its X509Certificate element. Absence of a device certificate or mismatched X509IssuerName and X509SerialNumber values shall be cause to fail the test.
10. Obtain the SM certificate of the Test Subject.
11. Using **openssl**, compare the certificate obtained in Step 10 to the device certificate obtained in Step 9. Mismatch between the two certificates shall be cause to fail the test.

If the Test Subject uses a dual certificate implementation as defined in Section 9.5.1.2 of [DCI-DCSS]:

1. Perform Steps 1-9 above.
2. Obtain the SM and LS certificates of the Test Subject.
3. Using a **Text Editor**, verify that the LogReport element contains a single reportingDevice child element as defined in [SMPTE-430-4]. Failure of this verification is cause to fail this test.
4. Using a **Text Editor**, verify that the reportingDevice element meets the following requirements. Failure to meet any of these requirements is cause to fail this test.
 - a. If the idtype attribute of the DeviceIdentifier element is equal to "DeviceUID", the DeviceCertID element shall also be present and shall contain the certificate thumbprint of the SM Certificate.
 - b. If the idtype attribute of the DeviceIdentifier element is equal to "DeviceUID", it shall contain the device UUID of the Test Subject.
 - c. If the idtype attribute of the DeviceIdentifier element is equal to "CertThumbprint", it shall contain the certificate thumbprint of the SM Certificate of the Test Subject.
 - d. The AdditionalID element shall be present and its value set to the certificate thumbprint of the LS Certificate, encoded as an ds:DigestValueType type.
5. Using **openssl**, compare the LS certificate obtained in Step 2 to the device certificate obtained in Step 9 above. Mismatch between the two certificates shall be cause to fail the test.

Supporting Materials

Reference Documents	DCI-DCSS, 9.4.6.3.1, 9.4.6.3.3, 9.4.6.3.7, 9.5.1.1, 9.5.1.2 SMPTE-430-4 SMPTE-430-5 SMPTE-433
Test Equipment	Text Editor openssl
Test Materials	<i>DCI 2K Sync Test (Encrypted)</i>

Consolidated Test Sequences

Sequence	Type	Measured Data
15.2. Integrated IMB Test Sequence	Pass/Fail	—
21.2. Integrated IMBO Test Sequence	Pass/Fail	—

5.3.2.7. Log Sequence Numbers (OBAE)

Objective

Verify that the OBAE-capable security manager (SM) maintains a secure and persistent counter to provide a unique sequential EventSequence number to each log record it creates. Verify that this EventSequence number appears in the Header node of each log record in a report.

Procedures

1. Set up and play a show using the composition *DCI 2K StEM (OBAE) (Encrypted)*, keyed with *KDM for 2K StEM (Encrypted) (OBAE)*.
2. Extract a security log report from the Test Subject that includes the range of time during which the above steps were carried out.
3. Examine the log report using a **Text Editor**. Verify that the header in each record contains an EventSequence value that is one greater than the value in the previous record.
4. Failure to correctly sequence log records in a report shall be cause to fail this test.

Supporting Materials

Reference Documents	DCI-DCSS, 9.4.6.3.1, 9.4.6.3.4 SMPTE-430-4 SMPTE-430-5
Test Equipment	Text Editor
Test Materials	<i>DCI 2K StEM (OBAE) (Encrypted)</i> <i>KDM for 2K StEM (Encrypted) (OBAE)</i>

Consolidated Test Sequences

Sequence	Type	Measured Data
20.2. OMB Test Sequence	Pass/Fail	—

5.3.2.8. Log Report Signature Validity (OBAE)

Objective

Verify that all Log Records within a Log Report are properly authenticated as specified in [SMPTE-430-4] and [SMPTE-430-5].

Verify that the Log Report is signed by the SM.

Verify that EventID for a given event is maintained across collections.

Procedures

Note:

The CPLStart and CPLend records are triggered by the first and last edit unit, respectively, of the CPL reproduced by the Test Subject. For example, in the case of an OMB with OBAE capability, the first and last edit units of the CPL are OBAE edit units, since picture edit units are not reproduced despite Main Picture assets being present in the CPL received by the OMB.

If the Test Subject uses a single certificate implementation as defined in Section 9.5.1.1 of [DCI-DCSS]:

1. Set up and play a show using the composition *DCI 2K Sync Test (OBAE) (Encrypted)*, keyed with *KDM for DCI 2K Sync Test (OBAE) (Encrypted)*.
2. Extract a Log Report from the Test Subject covering the time period during which Step 1 was performed.
3. Leave the system idle for no less than 1 minute, then extract a second security Log Report from the Test Subject covering the time period during which Step 1 was performed.
4. Using a **Text Editor**, locate in each of the Log Reports extracted in Steps 2 and 3 the CPLStart record. Failure for the records in the two reports to have the same EventID value is cause to fail this test. *Note: The following steps shall use the Log Report extracted in Step 2.*
5. Using a **Text Editor**, verify that the root element of the Log Report is LogReport. Failure of this verification is cause to fail the test.
6. Using a **Text Editor**, identify all individually signed Log Records and sequences of Log Records, as defined in [SMPTE-430-5]. Failure for any Log Record to either be signed individually or be part of a sequence is cause to fail this test.
7. Authenticate each individually signed Log Record identified in Step 4 as specified in [SMPTE-430-4] and [SMPTE-430-5], including:
 - a. Validating the recordBodyHash elements as specified in Section 6.1.1.5 of [SMPTE-430-5]; and
 - b. Validating the LogRecordSignature element as specified in Section 7.3 of [SMPTE-430-4] and Section 6.1.3 of [SMPTE-430-5].

Failure to authenticate any individually signed Log Record is cause to fail the test.

8. Authenticate each sequence of Log Records identified in Step 4 as specified in Section 9 of [SMPTE-430-4], including:

- a. Validating the `previousHeaderHash` (unless the Log Record is the first of a sequence) and `recordBodyHash` elements as specified in Section 6.1.1.5 of [SMPTE-430-5];
- b. Validating the authenticated chain as specified in Section 9 of [SMPTE-430-4]; and
- c. Validating the `LogRecordSignature` element as specified in Section 7.3 of [SMPTE-430-4] and Section 6.1.3 of [SMPTE-430-5].

Failure to authenticate any sequence of Log Records is cause to fail the test.

9. Using a **Text Editor**, locate one `LogRecordSignature` element. Using its `X509IssuerName` and `X509SerialNumber` from the `SignerCertInfo` element, locate elements that match in one of the `KeyInfo` elements and extract the device certificate from its `X509Certificate` element. Absence of a device certificate or mismatched `X509IssuerName` and `X509SerialNumber` values shall be cause to fail the test.
10. Obtain the SM certificate of the Test Subject.
11. Using **openssl**, compare the certificate obtained in Step 10 to the device certificate obtained in Step 9. Mismatch between the two certificates shall be cause to fail the test.

If the Test Subject uses a dual certificate implementation as defined in Section 9.5.1.2 of [DCI-DCSS]:

1. Perform Steps 1-9 above.
2. Obtain the SM and LS certificates of the Test Subject.
3. Using a **Text Editor**, verify that the `LogReport` element contains a single `reportingDevice` child element as defined in [SMPTE-430-4]. Failure of this verification is cause to fail this test.
4. Using a **Text Editor**, verify that the `reportingDevice` element meets the following requirements. Failure to meet any of these requirements is cause to fail this test.
 - a. If the `idtype` attribute of the `DeviceIdentifier` element is equal to "DeviceUID", the `DeviceCertID` element shall also be present and shall contain the certificate thumbprint of the SM Certificate.
 - b. If the `idtype` attribute of the `DeviceIdentifier` element is equal to "DeviceUID", it shall contain the device UUID of the Test Subject.
 - c. If the `idtype` attribute of the `DeviceIdentifier` element is equal to "CertThumbprint", it shall contain the certificate thumbprint of the SM Certificate of the Test Subject.
 - d. The `AdditionalID` element shall be present and its value set to the certificate thumbprint of the LS Certificate, encoded as an `ds:DigestValueType` type.
5. Using **openssl**, compare the LS certificate obtained in Step 2 to the device certificate obtained in Step 9 above. Mismatch between the two certificates shall be cause to fail the test.

Supporting Materials

Reference Documents	DCI-DCSS, 9.4.6.3.1, 9.4.6.3.3, 9.4.6.3.7, 9.5.1.1, 9.5.1.2 SMPTE-430-4 SMPTE-430-5 SMPTE-433
Test Equipment	Text Editor openssl
Test Materials	<i>DCI 2K Sync Test (OBAE) (Encrypted)</i> <i>KDM for DCI 2K Sync Test (OBAE) (Encrypted)</i>

Consolidated Test Sequences

Sequence	Type	Measured Data
20.2. OMB Test Sequence	Pass/Fail	—

5.3.3. SM Proxy of Log Events

5.3.3.1. Deleted Section

The section "SM Proxy of Log Events" was deleted. The section number is maintained here to preserve the numbering of subsequent sections.

5.3.3.2. Deleted Section

The section "SM Proxy of Security Operations Events" was deleted. The section number is maintained here to preserve the numbering of subsequent sections.

5.3.3.3. Deleted Section

The section "SM Proxy of Security ASM Events" was deleted. The section number is maintained here to preserve the numbering of subsequent sections.

5.3.3.4. Deleted Section

The section "Remote SPB Time Compensation" was deleted. The section number is maintained here to preserve the numbering of subsequent sections.

5.4. Security Log Events

Secure Processing Blocks (SPB) are required to record Security Log Events (defined in [SMPTE-430-5]) upon the occurrence of certain operational states. The procedures in this section should cause the Test Subject to record the respective events.

5.4.1. Payout, Validation and Key Events

5.4.1.1. FrameSequencePlayed Event

Objective

Verify that the SM can produce log records which contain correctly coded FrameSequencePlayed events per [SMPTE-430-5].

Procedures

1. Set up and play a show using the composition *DCI 2K Sync Test (Encrypted)*, keyed with *KDM for DCI 2K Sync Test (Encrypted)*. With an **Accurate Real-Time Clock**, note the UTC time at the moment the playback is started.
2. Extract a security log from the Test Subject that includes the range of time during which the above Steps were carried out.
3. Using a **Text Editor**, examine the log report for events occurring after the time recorded in Step 1. Verify that the log contains at least one record of Class Security, Type PLayout, Event Subtype FrameSequencePlayed.
4. Verify that the FrameSequencePlayed record has correctly formatted parameters as defined in [SMPTE-430-5].
5. Failure to correctly record a FrameSequencePlayed shall be cause to fail this test.

Supporting Materials

Reference Documents	DCI-DCSS, 9.4.6.3.7, 9.4.6.3.8 SMPTE-430-4 SMPTE-430-5
Test Equipment	Accurate Real-Time Clock Text Editor
Test Materials	<i>DCI 2K Sync Test (Encrypted)</i> <i>KDM for DCI 2K Sync Test (Encrypted)</i>

Consolidated Test Sequences

Sequence	Type	Measured Data
15.2. Integrated IMB Test Sequence	Pass/Fail	—
21.2. Integrated IMBO Test Sequence	Pass/Fail	—

5.4.1.2. CPLStart Event

Objective

Verify that the SM can produce log records which contain correctly coded CPLStart events per [SMPTE-430-5].

Procedures

Note:
The CPLStart and CPLEnd records are triggered by the first and last edit unit, respectively, of the CPL reproduced by the Test Subject. For example, in the case of an OMB with OBAE capability, the first and last edit units of the CPL are OBAE edit units, since picture edit units are not reproduced despite Main Picture assets being present in the CPL received by the OMB.

1. Set up and play a show using the composition *DCI 2K Sync Test (Encrypted)*, keyed with *KDM for DCI 2K Sync Test (Encrypted)*. With an **Accurate Real-Time Clock**, note the UTC time at the moment the playback is started.
2. Extract a security log from the Test Subject that includes the range of time during which the above Steps were carried out.
3. Using a **Text Editor**, examine the log report for events occurring after the time recorded in Step 1. Verify that the log contains at least one record of Class Security, Type PLayout, Event Subtype CPLStart.
4. Verify that the CPLStart record has correctly formatted parameters as defined in [SMPTE-430-5].
5. Failure to correctly record a CPLStart event shall be cause to fail this test.

Supporting Materials

Reference Documents	DCI-DCSS, 9.4.6.3.7, 9.4.6.3.8 SMPTE-430-4 SMPTE-430-5
Test Equipment	Accurate Real-Time Clock Text Editor
Test Materials	<i>DCI 2K Sync Test (Encrypted)</i> <i>KDM for DCI 2K Sync Test (Encrypted)</i>

Consolidated Test Sequences

Sequence	Type	Measured Data
15.2. Integrated IMB Test Sequence	Pass/Fail	—
21.2. Integrated IMBO Test Sequence	Pass/Fail	—

5.4.1.3. CPLEnd Event

Objective

Verify that the SM can produce log records which contain correctly coded CPLEnd events per [SMPTE-430-5].

Procedures

Note:

The CPLStart and CPLEnd records are triggered by the first and last edit unit, respectively, of the CPL reproduced by the Test Subject. For example, in the case of an OMB with OBAE capability, the first and last edit units of the CPL are OBAE edit units, since picture edit units are not reproduced despite Main Picture assets being present in the CPL received by the OMB.

1. Set up and play a show using the composition *DCI 2K Sync Test (Encrypted)*, keyed with *KDM for DCI 2K Sync Test (Encrypted)*. With an **Accurate Real-Time Clock**, note the UTC time at the moment the playback is

- started.
2. Extract a security log from the Test Subject that includes the range of time during which the above Steps were carried out.
 3. Using a **Text Editor**, examine the log report for events occurring after the time recorded in Step 1. Verify that the log contains at least one record of Class Security, Type PLayout, Event Subtype CPLend.
 4. Verify that the CPLend record has correctly formatted parameters as defined in [SMPTE-430-5].
 5. Failure to correctly record a CPLend event shall be cause to fail this test.

Supporting Materials

Reference Documents	DCI-DCSS, 9.4.6.3.7, 9.4.6.3.8 SMPTE-430-4 SMPTE-430-5
Test Equipment	Accurate Real-Time Clock Text Editor
Test Materials	<i>DCI 2K Sync Test (Encrypted)</i> <i>KDM for DCI 2K Sync Test (Encrypted)</i>

Consolidated Test Sequences

Sequence	Type	Measured Data
15.2. Integrated IMB Test Sequence	Pass/Fail	—
21.2. Integrated IMBO Test Sequence	Pass/Fail	—

5.4.1.4. PLayoutComplete Event

Objective

Verify that the SM can produce log records which contain correctly coded PLayoutComplete events per [SMPTE-430-5].

Procedures

1. Set up and play a show using the composition *DCI 2K Sync Test (Encrypted)*, keyed with *KDM for DCI 2K Sync Test (Encrypted)*. With an **Accurate Real-Time Clock**, note the UTC time at the moment the playback is started.
2. Extract a security log from the Test Subject that includes the range of time during which the above Steps were carried out.
3. Using a **Text Editor**, examine the log report for events occurring after the time recorded in Step 1. Verify that the log contains at least one record of Class Security, Type PLayout, Event Subtype PLayoutComplete.

4. Verify that the `PlayoutComplete` record has correctly formatted parameters as defined in [SMPTE-430-5].

5. Failure to correctly record a `PlayoutComplete` shall be cause to fail this test.

Supporting Materials

Reference Documents	DCI-DCSS, 9.4.6.3.7, 9.4.6.3.8 SMPTE-430-4 SMPTE-430-5
Test Equipment	Accurate Real-Time Clock Text Editor
Test Materials	<i>DCI 2K Sync Test (Encrypted)</i> <i>KDM for DCI 2K Sync Test (Encrypted)</i>

Consolidated Test Sequences

Sequence	Type	Measured Data
15.2. Integrated IMB Test Sequence	Pass/Fail	—
21.2. Integrated IMBO Test Sequence	Pass/Fail	—

5.4.1.5. CPLCheck Event

Objective

Verify that the SM can produce log records which contain correctly coded CPLCheck events per [SMPTE-430-5].

Procedures

1. If present, delete the composition *DCI 2K Sync Test (Encrypted)* from the Test Subject.
2. Ingest the composition *DCI 2K Sync Test (Encrypted)*. With an **Accurate Real-Time Clock**, note the UTC time at the moment the ingest is started.
3. Set up and play a show using the composition *DCI 2K Sync Test (Encrypted)*, keyed with *KDM for DCI 2K Sync Test (Encrypted)*.
4. Extract a security log from the Test Subject that includes the range of time during which the above Steps were carried out.
5. Using a **Text Editor**, examine the log report for events occurring after the time recorded in Step 2, less one minute. Verify that the log contains at least one record of Class Security, Type Validation, Event Subtype CPLCheck.
6. Verify that the CPLCheck record has correctly formatted parameters as defined in [SMPTE-430-5].
7. Failure to correctly record a CPLCheck event shall be cause to fail this test.

Supporting Materials

Reference Documents	DCI-DCSS, 9.4.6.3.7, 9.4.6.3.8 SMPTE-430-4 SMPTE-430-5
Test Equipment	Accurate Real-Time Clock Text Editor
Test Materials	<i>DCI 2K Sync Test (Encrypted)</i> <i>KDM for DCI 2K Sync Test (Encrypted)</i>

Consolidated Test Sequences

Sequence	Type	Measured Data
15.2. Integrated IMB Test Sequence	Pass/Fail	—
21.2. Integrated IMBO Test Sequence	Pass/Fail	—

5.4.1.6. KDMKeysReceived Event

Objective

Verify that the SM can produce log records which contain correctly coded KDMKeysReceived events per [SMPTE-430-5].

Procedures

1. Delete from the Test Subject any existing KDMs for the composition *DCI 2K Sync Test (Encrypted)*.
2. Ingest the KDM *KDM for DCI 2K Sync Test (Encrypted)*. With an **Accurate Real-Time Clock**, note the UTC time at the moment the ingest is started.
3. Set up and play a show using the composition *DCI 2K Sync Test (Encrypted)*, keyed with *KDM for DCI 2K Sync Test (Encrypted)*.
4. Extract a security log from the Test Subject that includes the range of time during which the above Steps were carried out.
5. Using a **Text Editor**, examine the log report for events near or after the time recorded in Step 2. Verify that the log contains at least one record of Class Security, Type Key, Event Subtype KDMKeysReceived.
6. Verify that the KDMKeysReceived record has correctly formatted parameters as defined in [SMPTE-430-5].
7. Failure to correctly record a KDMKeysReceived event shall be cause to fail this test.

Supporting Materials

Reference Documents	DCI-DCSS, 9.4.6.3.7, 9.4.6.3.8
----------------------------	--------------------------------

Test Equipment	SMPTE-430-4 SMPTE-430-5 Accurate Real-Time Clock Text Editor
Test Materials	<i>DCI 2K Sync Test (Encrypted)</i> <i>KDM for DCI 2K Sync Test (Encrypted)</i>

Consolidated Test Sequences

Sequence	Type	Measured Data
15.2. Integrated IMB Test Sequence	Pass/Fail	—
15.4. Integrated IMB Confidence Sequence	Pass/Fail	—
21.2. Integrated IMBO Test Sequence	Pass/Fail	—
21.4. Integrated IMBO Confidence Sequence	Pass/Fail	—

5.4.1.7. KDMDeleted Event

Objective

Verify that the SM can produce log records which contain correctly coded KDMDeleted events per [SMPTE-430-5].

Procedures

1. Set up and play a show using the composition *DCI 2K Sync Test (Encrypted)*, keyed with *KDM for DCI 2K Sync Test (Encrypted)*. With an **Accurate Real-Time Clock**, note the UTC time at the moment the playback is started.
2. Delete from the Test Subject any KDMs for the composition *DCI 2K Sync Test (Encrypted)*.
3. Attempt to play the composition *DCI 2K Sync Test (Encrypted)*. Successful playback shall be cause to fail this test.
4. Extract a security log from the Test Subject that includes the range of time during which the above Steps were carried out.
5. Using a **Text Editor**, examine the log report for events near or after the time recorded in Step 1. Verify that the log contains at least one record of Class Security, Type Key, Event Subtype KDMDeleted.
6. Verify that the KDMDeleted record has correctly formatted parameters as defined in [SMPTE-430-5].
7. Failure to correctly record a KDMDeleted event shall be cause to fail this test.

Supporting Materials

Reference Documents	DCI-DCSS, 9.4.6.3.7, 9.4.6.3.8 SMPTE-430-4
----------------------------	---

	SMPTE-430-5
Test Equipment	Accurate Real-Time Clock Text Editor
Test Materials	<i>DCI 2K Sync Test (Encrypted)</i> <i>KDM for DCI 2K Sync Test (Encrypted)</i>

Consolidated Test Sequences

Sequence	Type	Measured Data
15.2. Integrated IMB Test Sequence	Pass/Fail	—
21.2. Integrated IMBO Test Sequence	Pass/Fail	—

5.4.1.8. FrameSequencePlayed Event (OBAE)

Objective

Verify that the IMBO or OMB can produce, for an OBAE presentation, log records which contain correctly coded FrameSequencePlayed events per [SMPTE-430-5].

Procedures

1. Set up and play a show using the composition *DCI 2K Sync Test (OBAE) (Encrypted)*, keyed with *KDM for DCI 2K Sync Test (OBAE) (Encrypted)*. With an **Accurate Real-Time Clock**, note the UTC time at the moment the playback is started.
2. Extract a security log from the IMBO or OMB that includes the range of time during which the above Steps were carried out.
3. Using a **Text Editor**, examine the log report for events occurring after the time recorded in Step 1. Verify that the log contains at least one record of Class Security, Type `Playout`, Event Subtype `FrameSequencePlayed` associated with the OBAE essence in *DCI 2K Sync Test (OBAE) (Encrypted)*.
4. Verify that the `FrameSequencePlayed` record has correctly recorded parameters as defined in [SMPTE-430-5].
5. Verify that the `Parameters` list of the `FrameSequencePlayed` record contains a name/value pair whose `Name` element contains the token `OBAEMark`, and whose `Value` element shall contain one of two tokens, either `true` or `false`, indicating that a forensic mark was or was not inserted during playout.
6. Failure to correctly record a `FrameSequencePlayed` as detailed above shall be cause to fail this test.

Supporting Materials

Reference Documents	DCI-DCSS, 9.4.6.3.7, 9.4.6.3.8 SMPTE-430-4 SMPTE-430-5
Test Equipment	Accurate Real-Time Clock

Test Materials	<i>DCI 2K Sync Test (OBAE) (Encrypted)</i> <i>KDM for DCI 2K Sync Test (OBAE) (Encrypted)</i>
-----------------------	--

Consolidated Test Sequences

Sequence	Type	Measured Data
20.2. OMB Test Sequence	Pass/Fail	—
21.2. Integrated IMBO Test Sequence	Pass/Fail	—

5.4.1.9. CPLStart Event (OBAE)

Objective

Verify that the OBAE-capable SM can produce log records which contain correctly coded CPLStart events per [SMPTE-430-5].

Procedures

Note:
The CPLStart and CPLEnd records are triggered by the first and last edit unit, respectively, of the CPL reproduced by the Test Subject. For example, in the case of an OMB with OBAE capability, the first and last edit units of the CPL are OBAE edit units, since picture edit units are not reproduced despite Main Picture assets being present in the CPL received by the OMB.

1. Set up and play a show using the composition *DCI 2K Sync Test (Encrypted)*, keyed with *KDM for DCI 2K Sync Test (Encrypted)*. With an **Accurate Real-Time Clock**, note the UTC time at the moment the playback is started.
2. Extract a security log from the Test Subject that includes the range of time during which the above Steps were carried out.
3. Using a **Text Editor**, examine the log report for events occurring after the time recorded in Step 1. Verify that the log contains at least one record of Class Security, Type PLayout, Event Subtype CPLStart.
4. Verify that the CPLStart record has correctly formatted parameters as defined in [SMPTE-430-5].
5. Failure to correctly record a CPLStart event shall be cause to fail this test.

Supporting Materials

Reference Documents	DCI-DCSS, 9.4.6.3.7, 9.4.6.3.8 SMPTE-430-4 SMPTE-430-5
Test Equipment	Accurate Real-Time Clock Text Editor
Test Materials	<i>DCI 2K Sync Test (OBAE) (Encrypted)</i>

Consolidated Test Sequences

Sequence	Type	Measured Data
20.2. OMB Test Sequence	Pass/Fail	—
21.2. Integrated IMBO Test Sequence	Pass/Fail	—

5.4.1.10. CPLEnd Event (OBAE)

Objective

Verify that the OBAE-capable SM can produce log records which contain correctly coded CPLEnd events per [SMPTE-430-5].

Procedures

Note:

The CPLStart and CPLEnd records are triggered by the first and last edit unit, respectively, of the CPL reproduced by the Test Subject. For example, in the case of an OMB with OBAE capability, the first and last edit units of the CPL are OBAE edit units, since picture edit units are not reproduced despite Main Picture assets being present in the CPL received by the OMB.

1. Set up and play a show using the composition *DCI 2K Sync Test (OBAE) (Encrypted)*, keyed with *KDM for DCI 2K Sync Test (OBAE) (Encrypted)*. With an **Accurate Real-Time Clock**, note the UTC time at the moment the playback is started.
2. Extract a security log from the Test Subject that includes the range of time during which the above Steps were carried out.
3. Using a **Text Editor**, examine the log report for events occurring after the time recorded in Step 1. Verify that the log contains at least one record of Class Security, Type PLayout, Event Subtype CPLEnd.
4. Verify that the CPLEnd record has correctly formatted parameters as defined in [SMPTE-430-5].
5. Failure to correctly record a CPLEnd event shall be cause to fail this test.

Supporting Materials

Reference Documents	DCI-DCSS, 9.4.6.3.7, 9.4.6.3.8 SMPTE-430-4 SMPTE-430-5
Test Equipment	Accurate Real-Time Clock Text Editor
Test Materials	<i>DCI 2K Sync Test (OBAE) (Encrypted)</i> <i>KDM for DCI 2K Sync Test (OBAE) (Encrypted)</i>

Consolidated Test Sequences

Sequence	Type	Measured Data
20.2. OMB Test Sequence	Pass/Fail	—
21.2. Integrated IMBO Test Sequence	Pass/Fail	—

5.4.1.11. PayoutComplete Event (OBAE)

Objective

Verify that the OBAE-capable SM can produce log records which contain correctly coded PayoutComplete events per [SMPTE-430-5].

Procedures

1. Set up and play a show using the composition *DCI 2K Sync Test (OBAE) (Encrypted)*, keyed with *KDM for DCI 2K Sync Test (OBAE) (Encrypted)*. With an **Accurate Real-Time Clock**, note the UTC time at the moment the playback is started.
2. Extract a security log from the Test Subject that includes the range of time during which the above Steps were carried out.
3. Using a **Text Editor**, examine the log report for events occurring after the time recorded in Step 1. Verify that the log contains at least one record of Class Security, Type Payout, Event Subtype PayoutComplete.
4. Verify that the PayoutComplete record has correctly formatted parameters as defined in [SMPTE-430-5].
5. Failure to correctly record a PayoutComplete shall be cause to fail this test.

Supporting Materials

Reference Documents	DCI-DCSS, 9.4.6.3.7, 9.4.6.3.8 SMPTE-430-4 SMPTE-430-5
Test Equipment	Accurate Real-Time Clock Text Editor
Test Materials	<i>DCI 2K Sync Test (OBAE) (Encrypted)</i> <i>KDM for DCI 2K Sync Test (OBAE) (Encrypted)</i>

Consolidated Test Sequences

Sequence	Type	Measured Data
20.2. OMB Test Sequence	Pass/Fail	—
21.2. Integrated IMBO Test Sequence	Pass/Fail	—

5.4.1.12. CPLCheck Event (OBAE)

Objective

Verify that the OBAE-capable SM can produce log records which contain correctly coded CPLCheck events per [SMPTE-430-5].

Procedures

1. If present, delete the composition *DCI 2K Sync Test (OBAE) (Encrypted)* from the Test Subject.
2. Ingest the composition *DCI 2K Sync Test (OBAE) (Encrypted)*. With an **Accurate Real-Time Clock**, note the UTC time at the moment the ingest is started.
3. Set up and play a show using the composition *DCI 2K Sync Test (OBAE) (Encrypted)*, keyed with *KDM for DCI 2K Sync Test (OBAE) (Encrypted)*.
4. Extract a security log from the Test Subject that includes the range of time during which the above Steps were carried out.
5. Using a **Text Editor**, examine the log report for events occurring after the time recorded in Step 2, less one minute. Verify that the log contains at least one record of Class Security, Type Validation, Event Subtype CPLCheck.
6. Verify that the CPLCheck record has correctly formatted parameters as defined in [SMPTE-430-5].
7. Failure to correctly record a CPLCheck event shall be cause to fail this test.

Supporting Materials

Reference Documents	DCI-DCSS, 9.4.6.3.7, 9.4.6.3.8 SMPTE-430-4 SMPTE-430-5
Test Equipment	Accurate Real-Time Clock Text Editor
Test Materials	<i>DCI 2K Sync Test (OBAE) (Encrypted)</i> <i>KDM for DCI 2K Sync Test (OBAE) (Encrypted)</i>

Consolidated Test Sequences

Sequence	Type	Measured Data
20.2. OMB Test Sequence	Pass/Fail	—
21.2. Integrated IMBO Test Sequence	Pass/Fail	—

5.4.1.13. KDMKeysReceived Event (OBAE)

Objective

Verify that the OBAE-capable SM can produce log records which contain correctly coded KDMKeysReceived events per [SMPTE-430-5].

Procedures

1. Delete from the Test Subject any existing KDMs for the composition *DCI 2K Sync Test (OBAE) (Encrypted)*.
2. Ingest the KDM *KDM for DCI 2K Sync Test (OBAE) (Encrypted)*. With an **Accurate Real-Time Clock**, note the UTC time at the moment the ingest is started.
3. Set up and play a show using the composition *DCI 2K Sync Test (OBAE) (Encrypted)*, keyed with *KDM for DCI 2K Sync Test (OBAE) (Encrypted)*.
4. Extract a security log from the Test Subject that includes the range of time during which the above Steps were carried out.
5. Using a **Text Editor**, examine the log report for events near or after the time recorded in Step 2. Verify that the log contains at least one record of Class Security, Type Key, Event Subtype KDMKeysReceived.
6. Verify that the KDMKeysReceived record has correctly formatted parameters as defined in [SMPTE-430-5].
7. Failure to correctly record a KDMKeysReceived event shall be cause to fail this test.

Supporting Materials

Reference Documents	DCI-DCSS, 9.4.6.3.7, 9.4.6.3.8 SMPTE-430-4 SMPTE-430-5
Test Equipment	Accurate Real-Time Clock Text Editor
Test Materials	<i>DCI 2K Sync Test (OBAE) (Encrypted)</i> <i>KDM for DCI 2K Sync Test (OBAE) (Encrypted)</i>

Consolidated Test Sequences

Sequence	Type	Measured Data
20.2. OMB Test Sequence	Pass/Fail	—
20.4. OMB Confidence Sequence	Pass/Fail	—

5.4.1.14. KDMDeleted Event (OBAE)

Objective

Verify that the OBAE-capable SM can produce log records which contain correctly coded KDMDeleted events per [SMPTE-430-5].

Procedures

1. Set up and play a show using the composition *DCI 2K Sync Test (OBAE) (Encrypted)*, keyed with *KDM for DCI 2K Sync Test (OBAE) (Encrypted)*. With an **Accurate Real-Time Clock**, note the UTC time at the moment the playback is started.
2. Delete from the Test Subject any KDMs for the composition *DCI 2K Sync Test (OBAE) (Encrypted)*.
3. Attempt to play the composition *DCI 2K Sync Test (OBAE) (Encrypted)*. Successful playback shall be cause to fail this test.
4. Extract a security log from the Test Subject that includes the range of time during which the above Steps were carried out.
5. Using a **Text Editor**, examine the log report for events near or after the time recorded in Step 1. Verify that the log contains at least one record of Class Security, Type Key, Event Subtype *KDMDeleted*.
6. Verify that the *KDMDeleted* record has correctly formatted parameters as defined in [SMPTE-430-5].
7. Failure to correctly record a *KDMDeleted* event shall be cause to fail this test.

Supporting Materials

Reference Documents	DCI-DCSS, 9.4.6.3.7, 9.4.6.3.8 SMPTE-430-4 SMPTE-430-5
Test Equipment	Accurate Real-Time Clock Text Editor
Test Materials	<i>DCI 2K Sync Test (OBAE) (Encrypted)</i> <i>KDM for DCI 2K Sync Test (OBAE) (Encrypted)</i>

Consolidated Test Sequences

Sequence	Type	Measured Data
20.2. OMB Test Sequence	Pass/Fail	—

5.4.2. ASM and Operations Events

5.4.2.1. Deleted Section

The section "LinkOpened Event" was deleted. The section number is maintained here to preserve the numbering of subsequent sections.

5.4.2.2. Deleted Section

The section "LinkClosed Event" was deleted. The section number is maintained here to preserve the numbering of subsequent sections.

5.4.2.3. Deleted Section

The section "LinkException Event" was deleted. The section number is maintained here to preserve the numbering of subsequent sections.

5.4.2.4. Deleted Section

The section "LogTransfer Event" was deleted. The section number is maintained here to preserve the numbering of subsequent sections.

5.4.2.5. Deleted Section

The section "KeyTransfer Event" was deleted. The section number is maintained here to preserve the numbering of subsequent sections.

5.4.2.6. SPBStartup and SPBShutdown Events

Objective

Verify that the SM can produce log records which contain correctly coded SPBStartup and SPBShutdown events per [SMPTE-430-5].

Procedures

If the Test Subject is a Media Block:

1. Power up the Test Subject. With an **Accurate Real-Time Clock**, note the UTC time at the moment the power is applied.
2. Wait for the system to become idle.
3. Power down the Test Subject using the procedure recommended by the manufacturer. With an *Accurate Real-Time Clock*, note the UTC time at the moment the shutdown procedure is initiated.
4. Wait for the system to power down completely.
5. Power up the Test Subject. With an **Accurate Real-Time Clock**, note the UTC time at the moment the power is applied.
6. Wait for the system to become idle.
7. Interrupt line power to the Test Subject and associated suite equipment. With an **Accurate Real-Time Clock**, note the UTC time at the moment the power is removed. *Note: If applicable, make sure that the projector lamp is off when interrupting power.*
8. Wait for the system to power down completely.
9. Power up the Test Subject and associated suite equipment, wait for the system to become idle.
10. Extract a security log report from the Test Subject that includes the range of time during which the above steps were carried out.

11. Using a **Text Editor**, examine the log report for events recorded by the Test Subject. Verify that these events include at least one record of Class Security, Type 0operations, Event Subtypes SPBStartup and SPBShutdown, for each of (a) between the times recorded in step 1 and step 5 and (b) after the time recorded in step 5.
12. Verify that the SPBStartup and SPBShutdown records have correctly formatted parameters as defined in [SMPTE-430-5].
13. Failure to correctly record SPBStartup and SPBShutdown events shall be cause to fail this test.

Supporting Materials

Reference Documents	DCI-DCSS, 9.4.6.3.7, 9.4.6.3.8 SMPTE-430-4 SMPTE-430-5
Test Equipment	Computer with POSIX OS Accurate Real-Time Clock Text Editor

Consolidated Test Sequences

Sequence	Type	Measured Data
15.2. Integrated IMB Test Sequence	Pass/Fail	—
20.2. OMB Test Sequence	Pass/Fail	—
21.2. Integrated IMBO Test Sequence	Pass/Fail	—

5.4.2.7. SPBOpen and SPBClose Events

Objective

Verify that the SM of a Media Block, integrated or married to an Imaging Device, can produce log records which contain correctly coded SPBOpen and SPBClose events per [SMPTE-430-5].

Procedures

If the Test Subject is a Media Block integrated or married with an Imaging Device:

1. Power up the Test Subject and associated suite equipment, with an **Accurate Real-Time Clock**, note the UTC time at the moment the power is applied. Wait for the system to become idle.
2. Open a secure perimeter access door. Wait one minute, close the access door.
3. Extract a security log from the Test Subject that includes the range of time during which the above Steps were carried out.
4. Using a **Text Editor**, examine the log report for events occurring after the time recorded in Step 1. Verify that the log contains at least one record of Class Security, Type 0operations, Event Subtypes SPBOpen and SPBClose.

5. Verify that the SPBOpen and SPBClose records have correctly formatted parameters as defined in [SMPTE-430-5].
6. Failure to correctly record SPBOpen and SPBClose events shall be cause to fail this test.

Supporting Materials

Reference Documents	DCI-DCSS, 9.4.6.3.7, 9.4.6.3.8 SMPTE-430-4 SMPTE-430-5
Test Equipment	Computer with POSIX OS Accurate Real-Time Clock Text Editor

Consolidated Test Sequences

Sequence	Type	Measured Data
15.2. Integrated IMB Test Sequence	Pass/Fail	—
21.2. Integrated IMBO Test Sequence	Pass/Fail	—

5.4.2.8. SPBClockAdjust Event

Objective

Verify that the SM can produce log records which contain correctly coded SPBClockAdjust events per [SMPTE-430-5].

Procedures

If the Test Subject is a Media Block:

1. Power up the Test Subject and associated suite equipment, with an **Accurate Real-Time Clock**, note the UTC time at the moment the power is applied. Wait for the system to become idle.
2. Using the manufacturer's documented procedure, adjust the clock of the Test Subject.
3. Extract a security log from the Test Subject that includes the range of time during which the above Steps were carried out.
4. Using a **Text Editor**, examine the log report for events occurring after the time recorded in Step 1. Verify that the log contains at least one record of Class Security, Type Operations, Event Subtypes SPBClockAdjust.
5. Verify that the SPBClockAdjust records have correctly formatted parameters as defined in [SMPTE-430-5].
6. Failure to correctly record a SPBClockAdjust event shall be cause to fail this test.

Supporting Materials

Reference Documents	DCI-DCSS, 9.4.6.3.7, 9.4.6.3.8 SMPTE-430-4 SMPTE-430-5
Test Equipment	Computer with POSIX OS Accurate Real-Time Clock Text Editor

Consolidated Test Sequences

Sequence	Type	Measured Data
15.2. Integrated IMB Test Sequence	Pass/Fail	—
20.2. OMB Test Sequence	Pass/Fail	—
21.2. Integrated IMBO Test Sequence	Pass/Fail	—

5.4.2.9. SPBMarriage and SPBDivorce Events

Objective

Verify that the SM of a Media Block, married to an Imaging Device, can produce log records which contain correctly coded SPBMarriage and SPBDivorce events per [SMPTE-430-5].

Procedures

If the Test Subject is a Media Block married with an Imaging Device:

1. Power up the Test Subject and associated suite equipment, with an **Accurate Real-Time Clock**, note the UTC time at the moment the power is applied. Wait for the system to become idle.
2. Using the manufacturer's documented procedure, divorce the Media Block from its Imaging Device SPB2.
3. Using the manufacturer's documented procedure, remarry the Media Block to its Imaging Device SPB2.
4. Extract a security log from the Test Subject that includes the range of time during which the above Steps were carried out.
5. Using a **Text Editor**, examine the log report for events occurring after the time recorded in Step 1. Verify that the log contains at least one record of Class Security, Type Operations, Event Subtypes SPBMarriage and SPBDivorce.
6. Verify that the SPBMarriage and SPBDivorce records have correctly formatted parameters as defined in [SMPTE-430-5].
7. Failure to correctly record SPBMarriage and SPBDivorce events shall be cause to fail this test.

Supporting Materials

Reference Documents	DCI-DCSS, 9.4.6.3.7, 9.4.6.3.8
----------------------------	--------------------------------

Test Equipment	SMPTE-430-4
	SMPTE-430-5
	Computer with POSIX OS
	Accurate Real-Time Clock
	Text Editor

Consolidated Test Sequences

Sequence	Type	Measured Data
15.2. Integrated IMB Test Sequence	Pass/Fail	—
21.2. Integrated IMBO Test Sequence	Pass/Fail	—

5.4.2.10. SPBSoftware Event

Objective

Verify that the SM can produce log records which contain correctly coded SPBSoftware events per [SMPTE-430-5].

Procedures

If the Test Subject is a Media Block:

1. Power up the Test Subject and associated suite equipment, with an **Accurate Real-Time Clock**, note the UTC time at the moment the power is applied. Wait for the system to become idle.
2. Perform the following procedures:
 - a. Using the manufacturer's documented procedure, perform a software installation on the Test Subject.
 - b. Return the Test Subject to the idle state (reboot after software installation is acceptable).
 - c. Extract a security log from the Test Subject that includes the range of time during which the above Steps were carried out.
 - d. Using a **Text Editor**, examine the log report for events corresponding to the above steps. Verify that the log contains at least one record of Class Security, Type 0perations, Event Subtypes SPBSoftware.
 - e. Verify that the SPBSoftware records have correctly formatted parameters as defined in [SMPTE-430-5].
 - f. Failure to correctly record a SPBSoftware event shall be cause to fail this test.
3. Perform the following procedures:
 - a. Attempt a software installation on the Test Subject using a procedure that will cause the update to fail in some fashion (e.g. provide wrong signer for the update, incorrect message digest in module, consult with the manufacturer for additional assistance).
 - b. Return the Test Subject to the idle state.

- c. Extract a security log from the Test Subject that includes the range of time during which the above Steps were carried out.
- d. Using a **Text Editor**, examine the log report for events corresponding to the above steps. Verify that the log contains at least one record of Class Security, Type 0operations, Event Subtypes SPBSoftware.
- e. Verify that the SPBSoftware records have correctly formatted parameters as defined in [SMPTE-430-5]. Missing required elements or incorrect parameters shall be cause to fail this test.
- f. Confirm the presence of a SoftwareFailure exception in the SPBSoftware log record. Record any additional parameters associated with the exception. A missing SoftwareFailure exception in the associated SPBSoftware log record shall be cause to fail this test.

Supporting Materials

Reference Documents	DCI-DCSS, 9.4.6.3.7, 9.4.6.3.8 SMPTE-430-4 SMPTE-430-5
Test Equipment	Computer with POSIX OS Accurate Real-Time Clock Text Editor

Consolidated Test Sequences

Sequence	Type	Measured Data
15.2. Integrated IMB Test Sequence	Pass/Fail	—
15.4. Integrated IMB Confidence Sequence	Pass/Fail	—
20.2. OMB Test Sequence	Pass/Fail	—
21.2. Integrated IMBO Test Sequence	Pass/Fail	—
20.4. OMB Confidence Sequence	Pass/Fail	—
21.4. Integrated IMBO Confidence Sequence	Pass/Fail	—

5.4.2.11. SPBSecurityAlert Event

Objective

The following does not apply to a Test Subject that is an Imaging Device SPB. Verify that, where the SM can produce SPBSecurityAlert log events, the respective log records contain correctly coded SPBSecurityAlert events per [SMPTE-430-5].

Procedures

Note:
A SPBSecurityAlert record indicates an event that is not described by one of the other event record types defined in [SMPTE-430-5]. Each Test Subject must be evaluated to determine what conditions may result in a

SPBSecurityAlert event being logged. Detailed instructions must be provided by the manufacturer, including any test jigs or applications that may be required to perform the test.

1. Following the manufacturer's documented procedure, for each separately identified condition, configure the Test Subject and perform actions that will result in the logging of a SPBSecurityAlert event recording the condition.
2. Extract a security log from the Test Subject that includes the range of time during which the above Step 1 was carried out.
3. Using a **Text Editor**, examine the log report for events corresponding to the above Step 1. Verify that the log contains the expected number of records of Class Security, Type Operations, Event Subtypes SPBSecurityAlert. Verify that the SPBSecurityAlert records have correctly formatted parameters as defined in [SMPTE-430-5].
4. For each type of SPBSecurityAlert record, provide an explanation of the condition and any parameters that are recorded.

Supporting Materials

Reference Documents	DCI-DCSS, 9.4.6.3.7, 9.4.6.3.8, 9.4.6.3.8 SMPTE-430-4 SMPTE-430-5
Test Equipment	Computer with POSIX OS Accurate Real-Time Clock Text Editor

Consolidated Test Sequences

Sequence	Type	Measured Data
15.2. Integrated IMB Test Sequence	Data only	—
20.2. OMB Test Sequence	Data only	—
21.2. Integrated IMBO Test Sequence	Data only	—

Chapter 6. Media Block

The Media Block (MB) is a Type 1 SPB comprising a Security Manager (SM) and the Media Decryptors (MD) for all essence types, plus, as required, Forensic Marker (FM) for image or sound and a Timed Text rendering engine (alpha-channel overlay).

6.1. Security Manager (SM)

Note:

Some of the procedures in this section require test content that is specifically malformed. In some implementations, these malformations may be caught and reported directly by the SMS without involving the SM. Because the purpose of the procedures is to assure that the SM demonstrates the required behavior, the manufacturer of the Test Subject may need to

provide special test programs or special SMS testing modes to allow the malformed content to be applied directly to the SM.

6.1.1. Image Integrity Checking

Objective

- Verify that the SM detects and logs playback restarts.
- Verify that, for Image Track Files, the SM detects and logs deviations in the:
 - Sequence Number item of the Encrypted Triplet
 - TrackFile ID item of the Encrypted Triplet
 - Check Value of the Encrypted Source Value
 - MIC item of the Encrypted Triplet

Procedures

1. Using manufacturer-supplied documentation and by inspection, record a list of means by which playback of a particular composition can be interrupted and restarted. Such means may include command pairs such as pause/play, stop/play, etc. For each of these means:
 - a. Select for playback the composition *DCI 2K StEM (Encrypted)* keyed with *KDM for 2K StEM (Encrypted)*.
 - b. Start playback, interrupt playback and restart playback
 - c. Extract a security log from the Test Subject and using a **Text Editor** and identify the events associated with the playback.
 - d. Confirm that all required elements have correctly formatted parameters as defined in [SMPTE-430-5]. Missing required elements or incorrect parameters shall be cause to fail this test.
 - e. Confirm that there are at least 2 `FrameSequencePlayed` records for each track file included in the composition and that the `FirstFrame` and `LastFrame` parameter values reflect the interrupted playback.
 - f. Confirm that there is no `PlayoutComplete` event associated with the interrupted playback.
2. Start playback of the composition *DCI 2K StEM (Encrypted)* keyed with *KDM for 2K StEM (Encrypted)* and interrupt line power to the Test Subject before playback of the composition ends. Power up the Test Subject, wait for the system to become idle. Extract a security log from the Test Subject and using a **Text Editor**. Identify the events associated with the playback and:

- a. Confirm that all required elements have correctly formatted parameters as defined in [SMPTE-430-5]. Missing required elements or incorrect parameters shall be cause to fail this test.
 - b. Confirm that there are at least 1 `FrameSequencePlayed` record for each track file included in the composition and that the `FirstFrame` and `LastFrame` parameter values reflect the interrupted playback.
 - c. Confirm that there is no `LayoutComplete` event associated with the interrupted playback.
3. Play back the composition *DCI Malformed Test 1: Picture with Frame-out-of-order error (Encrypted)*, keyed with *KDM for DCI Malformed Test 1: Picture with Frame-out-of-order error (Encrypted)*. Extract a security log from the Test Subject and using a **Text Editor**, identify the events associated with the playback and:
- a. Confirm that all required elements have correctly formatted parameters as defined in [SMPTE-430-5]. Missing required elements or incorrect parameters shall be cause to fail this test.
 - b. Confirm the presence of a `FrameSequenceError` exception in the `FrameSequencePlayed` log record for the image track file. Record any additional parameters associated with the exception.
4. Play back the composition *DCI Malformed Test 5: DCP With an incorrect image TrackFile ID (Encrypted)*, keyed with *KDM for DCI Malformed Test 5: DCP With an incorrect image TrackFile ID (Encrypted)*. Extract a security log from the Test Subject and using a **Text Editor**, identify the events associated with the playback and:
- a. Confirm that all required elements have correctly formatted parameters as defined in [SMPTE-430-5]. Missing required elements or incorrect parameters shall be cause to fail this test.
 - b. Confirm the presence of a `TrackFileIDError` exception in the `FrameSequencePlayed` log record for the image track file. Record any additional parameters associated with the exception.
5. Play back the composition *DCI 2K Sync Test with KDM-Borne MIC Keys (Encrypted)*, keyed with *KDM with invalid MIC Key (Picture) for DCI 2K Sync Test with KDM-Borne MIC Keys (Encrypted)*. Extract a security log from the Test Subject and using a **Text Editor**, identify the events associated with the playback and:
- a. Confirm that all required elements have correctly formatted parameters as defined in [SMPTE-430-5]. Missing required elements or incorrect parameters shall be cause to fail this test.
 - b. Confirm the presence of a `FrameMICError` exception in the `FrameSequencePlayed` log record for the image track file. Record any additional parameters associated with the exception.
6. Play back the composition *DCI 2K Sync Test (Encrypted)*, keyed with *KDM with MIC Key (Picture) for DCI 2K Sync Test (Encrypted)*. Extract a security log from the Test Subject and using a **Text Editor**, identify the events associated with the playback and:
- a. Confirm that all required elements have correctly formatted parameters as defined in [SMPTE-430-5]. Missing required elements or incorrect parameters shall be cause to fail this test.

- b. Confirm the presence of a `FrameMICErr` exception in the `FrameSequencePlayed` log record for the image track file. Record any additional parameters associated with the exception.
7. Play back the composition *DCI Malformed Test 9: Picture with HMAC error in MXF Track File (Encrypted)*, keyed with *KDM for DCI Malformed Test 9: Picture with HMAC error in MXF Track File (Encrypted)*. Extract a security log from the Test Subject and using a **Text Editor**, identify the events associated with the playback and:
- a. Confirm that all required elements have correctly formatted parameters as defined in [SMPTE-430-5]. Missing required elements or incorrect parameters shall be cause to fail this test.
 - b. Confirm that there is no `FrameMICErr` exception in the `FrameSequencePlayed` log record for the image track file.
8. Play back the composition *DCI Malformed Test 11: Picture with Check Value error in MXF Track File (Encrypted)*, keyed with *KDM for DCI Malformed Test 11: Picture with Check Value error in MXF Track File (Encrypted)*. Extract a security log from the Test Subject and using a **Text Editor**, identify the events associated with the playback and:
- a. Confirm that all required elements have correctly formatted parameters as defined in [SMPTE-430-5]. Missing required elements or incorrect parameters shall be cause to fail this test.
 - b. Confirm the presence of a `CheckValueError` exception in the `FrameSequencePlayed` log record for the image track file. Record any additional parameters associated with the exception.

Failure of any of the above conditions is cause to fail this test.

Supporting Materials

Reference Documents	DCI-DCSS, 9.4.3.5 SMPTE-429-6 SMPTE-429-5
Test Equipment	Text Editor
Test Materials	<i>DCI 2K StEM (Encrypted)</i> <i>KDM for 2K StEM (Encrypted)</i> <i>DCI Malformed Test 1: Picture with Frame-out-of-order error (Encrypted)</i> <i>KDM for DCI Malformed Test 1: Picture with Frame-out-of-order error (Encrypted)</i> <i>DCI Malformed Test 5: DCP With an incorrect image TrackFile ID (Encrypted)</i> <i>KDM for DCI Malformed Test 5: DCP With an incorrect image TrackFile ID (Encrypted)</i> <i>DCI Malformed Test 9: Picture with HMAC error in MXF Track File (Encrypted)</i> <i>KDM for DCI Malformed Test 9: Picture with HMAC error in MXF Track File (Encrypted)</i>

DCI Malformed Test 11: Picture with Check Value error in MXF Track File (Encrypted)
 KDM for DCI Malformed Test 11: Picture with Check Value error in MXF Track File (Encrypted)
 DCI 2K Sync Test with KDM-Borne MIC Keys (Encrypted)
 KDM with invalid MIC Key (Picture) for DCI 2K Sync Test with KDM-Borne MIC Keys (Encrypted)
 DCI 2K Sync Test (Encrypted)
 KDM with MIC Key (Picture) for DCI 2K Sync Test (Encrypted)

Consolidated Test Sequences

Sequence	Type	Measured Data
15.2. Integrated IMB Test Sequence	Pass/Fail	—
21.2. Integrated IMBO Test Sequence	Pass/Fail	—

6.1.2. Sound Integrity Checking

Objective

Verify that, for Sound Track Files, the SM detects and logs deviations in the:

- Sequence Number item of the Encrypted Triplet
- TrackFile ID item of the Encrypted Triplet
- Check Value of the Encrypted Source Value
- MIC item of the Encrypted Triplet

Procedures

1. Play back the composition *DCI Malformed Test 2: Sound with Frame-out-of-order error (Encrypted)*, keyed with *KDM for DCI Malformed Test 2: Sound with Frame-out-of-order error (Encrypted)*. Extract a security log from the Test Subject and using a **Text Editor**, identify the events associated with the playback and:
 - a. Confirm that all required elements have correctly formatted parameters as defined in [SMPTE-430-5]. Missing required elements or incorrect parameters shall be cause to fail this test.
 - b. Confirm the presence of a `FrameSequenceError` exception in the `FrameSequencePlayed` log record for the sound track file. Record any additional parameters associated with the exception.
2. Play back the composition *DCI Malformed Test 4: DCP With an incorrect audio TrackFile ID (Encrypted)*, keyed with *KDM for DCI Malformed Test 4: DCP With an incorrect audio TrackFile ID (Encrypted)*. Extract a security log from the Test Subject and using a **Text Editor**, identify the events associated with the playback and:

- a. Confirm that all required elements have correctly formatted parameters as defined in [SMPTE-430-5]. Missing required elements or incorrect parameters shall be cause to fail this test.
 - b. Confirm the presence of a `TrackFileIDError` exception in the `FrameSequencePlayed` log record for the sound track file. Record any additional parameters associated with the exception.
3. Play back the composition *DCI 2K Sync Test with KDM-Borne MIC Keys (Encrypted)*, keyed with *KDM with invalid MIC Key (Sound) for DCI 2K Sync Test with KDM-Borne MIC Keys (Encrypted)*. Extract a security log from the Test Subject and using a **Text Editor**, identify the events associated with the playback and:
 - a. Confirm that all required elements have correctly formatted parameters as defined in [SMPTE-430-5]. Missing required elements or incorrect parameters shall be cause to fail this test.
 - b. Confirm the presence of a `FrameMICError` exception in the `FrameSequencePlayed` log record for the sound track file. Record any additional parameters associated with the exception.
4. Play back the composition *DCI 2K Sync Test (Encrypted)*, keyed with *KDM with MIC Key (Sound) for DCI 2K Sync Test (Encrypted)*. Extract a security log from the Test Subject and using a **Text Editor**, identify the events associated with the playback and:
 - a. Confirm that all required elements have correctly formatted parameters as defined in [SMPTE-430-5]. Missing required elements or incorrect parameters shall be cause to fail this test.
 - b. Confirm the presence of a `FrameMICError` exception in the `FrameSequencePlayed` log record for the sound track file. Record any additional parameters associated with the exception.
5. Play back the composition *DCI Malformed Test 10: Sound with HMAC error in MXF Track File (Encrypted)*, keyed with *KDM for DCI Malformed Test 10: Sound with HMAC error in MXF Track File (Encrypted)*. Extract a security log from the Test Subject and using a **Text Editor**, identify the events associated with the playback and:
 - a. Confirm that all required elements have correctly formatted parameters as defined in [SMPTE-430-5]. Missing required elements or incorrect parameters shall be cause to fail this test.
 - b. Confirm that there is no `FrameMICError` exception in the `FrameSequencePlayed` log record for the sound track file.
6. Play back the composition *DCI Malformed Test 12: Sound with Check Value error in MXF Track File (Encrypted)*, keyed with *KDM for DCI Malformed Test 12: Sound with Check Value error in MXF Track File (Encrypted)*. Extract a security log from the Test Subject and using a **Text Editor**, identify the events associated with the playback and:
 - a. Confirm that all required elements have correctly formatted parameters as defined in [SMPTE-430-5]. Missing required elements or incorrect parameters shall be cause to fail this test.
 - b. Confirm the presence of a `CheckValueError` exception in the `FrameSequencePlayed` log record for the sound track file. Record any additional parameters associated with the exception.

Failure of any of the above conditions is cause to fail this test.

Supporting Materials

Reference Documents	DCI-DCSS, 9.4.3.5
Test Equipment	Text Editor
Test Materials	<p><i>DCI Malformed Test 2: Sound with Frame-out-of-order error (Encrypted)</i> <i>KDM for DCI Malformed Test 2: Sound with Frame-out-of-order error (Encrypted)</i></p> <p><i>DCI Malformed Test 4: DCP With an incorrect audio TrackFile ID (Encrypted)</i> <i>KDM for DCI Malformed Test 4: DCP With an incorrect audio TrackFile ID (Encrypted)</i></p> <p><i>DCI 2K Sync Test with KDM-Borne MIC Keys (Encrypted)</i> <i>KDM with invalid MIC Key (Sound) for DCI 2K Sync Test with KDM-Borne MIC Keys (Encrypted)</i></p> <p><i>DCI 2K Sync Test (Encrypted)</i> <i>KDM with MIC Key (Sound) for DCI 2K Sync Test (Encrypted)</i></p> <p><i>DCI Malformed Test 10: Sound with HMAC error in MXF Track File (Encrypted)</i> <i>KDM for DCI Malformed Test 10: Sound with HMAC error in MXF Track File (Encrypted)</i></p> <p><i>DCI Malformed Test 12: Sound with Check Value error in MXF Track File (Encrypted)</i> <i>KDM for DCI Malformed Test 12: Sound with Check Value error in MXF Track File (Encrypted)</i></p>

Consolidated Test Sequences

Sequence	Type	Measured Data
15.2. Integrated IMB Test Sequence	Pass/Fail	—
21.2. Integrated IMBO Test Sequence	Pass/Fail	—

6.1.3. Deleted Section

The section "Restriction of Keying to Monitored Link Decryptors" was deleted. The section number is maintained here to preserve the numbering of subsequent sections.

6.1.4. Restriction of Keying to MD Type

Objective

Verify that keys are issued only to a Media Decryptor (MD) matching the key type as specified in the KDM per [SMPTE-430-1].

Procedures

1. Load the KDM *KDM with mismatched keytype*, which contains a valid decryption key for image, but the Key Type is mismatched.

2. Load and attempt to play the composition *DCI 2K StEM (Encrypted)*. Successful playback shall be cause to fail this test.
3. Extract a security log from the Test Subject and using a **Text Editor**, identify the events associated with the operation and:
 - a. Confirm that all required elements have correctly formatted parameters as defined in [SMPTE-430-5]. Missing required elements or incorrect parameters shall be cause to fail this test.
 - b. Confirm the presence of an associated `FrameSequencePlayed` log record that contains a `KeyTypeError` exception. Record any additional parameters associated with the exception. Failure to produce correct log records shall be cause to fail this test.

Supporting Materials

Reference Documents	DCI-DCSS, 9.4.3.5 SMPTE-430-1 SMPTE-430-5
Test Materials	<i>KDM with mismatched keytype</i> <i>DCI 2K StEM (Encrypted)</i>

Consolidated Test Sequences

Sequence	Type	Measured Data
15.2. Integrated IMB Test Sequence	Pass/Fail	—
21.2. Integrated IMBO Test Sequence	Pass/Fail	—

6.1.5. Restriction of Keying to Valid CPLs

Objective

Verify that the SM validates CPLs and logs results as a prerequisite to preparing the suite for the associated composition playback.

Procedures

1. Supply the CPL *DCI Malformed Test 6: CPL with incorrect track file hashes (Encrypted)*, keyed with KDM for *DCI Malformed Test 6: CPL with incorrect track file hashes (Encrypted)*, to the SM. Verify that the SM rejects the CPL. If the SM accepts the CPL, this is cause to fail this test.
2. Attempt to start playback and verify that it is not possible. If playback starts, this is cause to fail this test.
3. Extract a security log from the Test Subject and using a **Text Editor**, identify the `CPLCheck` event associated with the above operation and:

- a. Confirm that all required elements have correctly formatted parameters as defined in [SMPTE-430-5]. Verify that the `contentId` element contains the `Id` of the CPL. Verify that the value of the `SignerID` parameter contains the Certificate Thumbprint of the certificate used to sign the CPL. Verify that `ReferencedIDs` element contains a `CompositionID` parameter with a value that is the `Id` of the CPL. Missing required elements or incorrect parameters shall be cause to fail this test.
 - b. Confirm the presence of a `AssetHashError` exception in the `CPLCheck` log record. Record any additional parameters associated with the exception. A missing `AssetHashError` exception shall be cause to fail this test.
4. Supply the CPL *DCI Malformed Test 7: CPL with an Invalid Signature (Encrypted)*, keyed with *KDM for DCI Malformed Test 7: CPL with an Invalid Signature (Encrypted)* to the SM. Verify that the SM rejects the CPL. If the SM accepts the CPL, this is cause to fail this test.
5. Attempt to start playback and verify that it is not possible. If playback starts, this is cause to fail this test.
6. Extract a security log from the Test Subject and using a **Text Editor**, identify the `CPLCheck` event associated with the above operation and:
 - a. Confirm that all required elements have correctly formatted parameters as defined in [SMPTE-430-5]. Verify that the `contentId` element contains the `Id` of the CPL. Verify that `ReferencedIDs` element contains a `CompositionID` parameter with a value that is the `Id` of the CPL. Missing required elements or incorrect parameters shall be cause to fail this test.
 - b. Confirm the presence of a `SignatureError` exception in the `CPLCheck` log record. Record any additional parameters associated with the exception. A missing `SignatureError` exception shall be cause to fail this test.
7. Supply the CPL *DCI Malformed Test 13: CPL that references a non-existent track file (Encrypted)*, keyed with *KDM for DCI Malformed Test 13: CPL that references a non-existent track file (Encrypted)* to the SM. Verify that the SM rejects the CPL. If the SM accepts the CPL, this is cause to fail this test.
8. Attempt to start playback and verify that it is not possible. If playback starts, this is cause to fail this test.
9. Extract a security log from the Test Subject and using a **Text Editor**, identify the `CPLCheck` event associated with the above operation and:
 - a. Confirm that all required elements have correctly formatted parameters as defined in [SMPTE-430-5]. Verify that the `contentId` element contains the `Id` of the CPL. Verify that the value of the `SignerID` parameter contains the Certificate Thumbprint of the certificate used to sign the CPL. Verify that `ReferencedIDs` element contains a `CompositionID` parameter with a value that is the `Id` of the CPL. Missing required elements or incorrect parameters shall be cause to fail this test.
 - b. Confirm the presence of a `AssetMissingError` exception in the `CPLCheck` log record. Record any additional parameters associated with the exception. A missing `AssetMissingError` exception shall be cause to fail this test.

10. Supply the CPL *DCI Malformed Test 14: CPL that does not conform to ST 429-7 (Encrypted)*, keyed with KDM for DCI Malformed Test 14: *CPL that does not conform to ST 429-7 (Encrypted)* to the SM. Verify that the SM rejects the CPL. If the SM accepts the CPL, this is cause to fail this test.
11. Attempt to start playback and verify that it is not possible. If playback starts, this is cause to fail this test.
12. Extract a security log from the Test Subject and using a **Text Editor**, identify the CPLCheck event associated with the above operation and:
 - a. Confirm that all required elements have correctly formatted parameters as defined in [SMPTE-430-5]. Missing required elements or incorrect parameters shall be cause to fail this test.
 - b. Confirm the presence of a CPLFormatError exception in the CPLCheck log record. Record any additional parameters associated with the exception. A missing CPLFormatError exception shall be cause to fail this test.
13. Supply the CPL *DCI Malformed Test 15: CPL signed by a certificate not conforming to ST 430-2 (Encrypted)*, keyed with KDM for DCI Malformed Test 15: *CPL signed by a certificate not conforming to ST 430-2 (Encrypted)* to the SM. Verify that the SM rejects the CPL. If the SM accepts the CPL, this is cause to fail this test.
14. Attempt to start playback and verify that it is not possible. If playback starts, this is cause to fail this test.
15. Extract a security log from the Test Subject and using a **Text Editor**, identify the CPLCheck event associated with the above operation and:
 - a. Confirm that all required elements have correctly formatted parameters as defined in [SMPTE-430-5]. Verify that the contentId element contains the Id of the CPL. Verify that ReferencedIDs element contains a CompositionID parameter with a value that is the Id of the CPL. Missing required elements or incorrect parameters shall be cause to fail this test.
 - b. Confirm the presence of a CertFormatError exception in the CPLCheck log record. Record any additional parameters associated with the exception. A missing CertFormatError exception shall be cause to fail this test.

Supporting Materials

Reference Documents	DCI-DCSS, 9.4.3.5 SMPTE-430-5
Test Materials	<i>DCI Malformed Test 6: CPL with incorrect track file hashes (Encrypted)</i> <i>KDM for DCI Malformed Test 6: CPL with incorrect track file hashes (Encrypted)</i> <i>DCI Malformed Test 7: CPL with an Invalid Signature (Encrypted)</i> <i>KDM for DCI Malformed Test 7: CPL with an Invalid Signature (Encrypted)</i>

DCI Malformed Test 13: CPL that references a non-existent track file (Encrypted)
KDM for DCI Malformed Test 13: CPL that references a non-existent track file (Encrypted)
DCI Malformed Test 14: CPL that does not conform to ST 429-7 (Encrypted)
KDM for DCI Malformed Test 14: CPL that does not conform to ST 429-7 (Encrypted)
DCI Malformed Test 15: CPL signed by a certificate not conforming to ST 430-2 (Encrypted)
KDM for DCI Malformed Test 15: CPL signed by a certificate not conforming to ST 430-2 (Encrypted)

Consolidated Test Sequences

Sequence	Type	Measured Data
15.2. Integrated IMB Test Sequence	Pass/Fail	—
15.4. Integrated IMB Confidence Sequence	Pass/Fail	—
21.2. Integrated IMBO Test Sequence	Pass/Fail	—
21.4. Integrated IMBO Confidence Sequence	Pass/Fail	—

6.1.6. Deleted Section

The section "Remote SPB Integrity Monitoring" was deleted. The section number is maintained here to preserve the numbering of subsequent sections.

6.1.7. Deleted Section

The section "SPB Integrity Fault Consequences" was deleted. The section number is maintained here to preserve the numbering of subsequent sections.

6.1.8. Content Key Extension, End of Engagement

Objective

Verify that to avoid end of engagement issues, composition playout may extend beyond the end of the KDM's playout time window, if started within the KDM playout time window, by a maximum of 6 hours.

Procedures

Note:

This test will require KDMs that contain ContentKeysNotValidAfter elements set to a time in the near future. It is recommended that fresh KDMs be generated that will expire 30-60 minutes after beginning the test procedures. Refer to information provided in the relevant step to ensure that the applicable KDM is being used at the appropriate absolute time the step of the test is carried out.

Note:

The Test Operator is required to take into account any timezone offsets that may apply to the locality of the Test

Subject and the representation of the `ContentKeysNotValidAfter` element of the KDM. For clarity it is recommended that a common representation be used.

Note:

The Security Manager's (SM) clock must be accurately set, to the extent possible, for successful execution of this test.

Note:

The `CPLStart` and `CPEnd` records are triggered by the first and last edit unit, respectively, of the CPL reproduced by the Test Subject. For example, in the case of an OMB with OBAE capability, the first and last edit units of the CPL are OBAE edit units, since picture edit units are not reproduced despite Main Picture assets being present in the CPL received by the OMB.

1. Using a **Text Editor**, open the KDM *KDM for Past Time Window Extension (Encrypted)* and note the value of the timestamp contained in the `<ContentKeysNotValidAfter>` element (i.e. the KDM's end of validity timestamp). *Note: Steps 2 and 3 must be commenced before the time recorded in this step.*
2. Load the composition *End of Engagement -Past Time Window Extension (Encrypted)*, keyed with *KDM for Past Time Window Extension (Encrypted)*. *End of Engagement -Past Time Window Extension (Encrypted)* is a composition which is 6 hours and 11 minutes in length.
3. Within 5 minutes prior to the timestamp recorded in step 1, attempt to start playing *End of Engagement -Past Time Window Extension (Encrypted)*. Because the complete show extends beyond the 6 hours end of engagement extension window, the composition should not start playback. If the composition starts to playback, this is cause to fail this test.
4. Using a **Text Editor**, open the KDM *KDM for Within Time Window Extension (Encrypted)* and note the value of the timestamp contained in the `<ContentKeysNotValidAfter>` element (i.e. the KDM's end of validity timestamp). *Note: Steps 5 and 6 must be commenced before the time recorded in this step.*
5. Load the composition *End of Engagement - Within Time Window Extension (Encrypted)*, keyed with *KDM for Within Time Window Extension (Encrypted)*. *End of Engagement - Within Time Window Extension (Encrypted)* has a duration of 5 hours, 59 minutes and 30 seconds.
6. Within 5 minutes prior to the timestamp recorded in step 4, attempt to start playing *End of Engagement - Within Time Window Extension (Encrypted)*. The composition should start to playback and continue playing in its entirety. If the show fails to start or fails to playout completely, this is cause to fail this test.
Note: The test operator does not have to be present for the entire playback. Sufficient proof of successful playback can be observed by examining the security log for complete `FrameSequencePlayed`, `CPEnd` and `PlayoutComplete` events.

Supporting Materials

Reference Documents

DCI-DCSS, 9.4.3.5

Test Equipment

Test Materials	Text Editor
	<i>End of Engagement - Within Time Window Extension (Encrypted)</i>
	<i>End of Engagement -Past Time Window Extension (Encrypted)</i>
	<i>KDM for Within Time Window Extension (Encrypted)</i>
	<i>KDM for Past Time Window Extension (Encrypted)</i>

Consolidated Test Sequences

Sequence	Type	Measured Data
15.2. Integrated IMB Test Sequence	Pass/Fail	—
15.4. Integrated IMB Confidence Sequence	Pass/Fail	—
21.2. Integrated IMBO Test Sequence	Pass/Fail	—
21.4. Integrated IMBO Confidence Sequence	Pass/Fail	—

6.1.9. ContentAuthenticator Element Check

Objective

- Verify that the Test Subject checks that one of the certificates in the certificate chain supplied with the CPL has a certificate thumbprint that matches the value of the KDM <ContentAuthenticator> element.
- Verify that the Test Subject checks that such certificate indicates only a "Content Signer (CS) role.

Procedures

For each of the malformations below, load the indicated CPL and KDM on to the Test Subject. Verify that the the KDM is not used to enable playback. A successful playback is cause to fail this test.

1. Use the composition *DCI 2K StEM (Encrypted)* and supply the KDM *KDM with invalid ContentAuthenticator*. The KDM contains a <ContentAuthenticator> element having a certificate thumbprint value that does not match the thumbprint of one of the signer certificates in the certificate chain that signed the associated CPL.
2. Use the composition *DCI Malformed Test 16: CPL signed with No Role Certificate (Encrypted)* and supply the KDM *KDM for DCI Malformed Test 16: CPL signed with No Role Certificate (Encrypted)*. The KDM contains a <ContentAuthenticator> element having a certificate thumbprint value that matches the thumbprint of one of the signer certificates in the certificate chain that signed the associated CPL but that certificate has no role.
3. Use the composition *DCI Malformed Test 17: CPL signed with Bad Role Certificate (Encrypted)* and supply the KDM *KDM for DCI Malformed Test 17: CPL signed with Bad Role Certificate (Encrypted)*. The KDM contains a <ContentAuthenticator> element having a certificate thumbprint value that matches the thumbprint of one of the signer certificates in the certificate chain that signed the associated CPL but that certificate has a bad role (SM).
4. Use the composition *DCI Malformed Test 18: CPL signed with Extra Role Certificate (Encrypted)* and supply the KDM *KDM for DCI Malformed Test 18: KDM for CPL signed with Extra Role Certificate (Encrypted)*. The KDM contains a <ContentAuthenticator> element having a certificate thumbprint value that matches the

thumbprint of one of the signer certificates in the certificate chain that signed the associated CPL but that certificate has an extra role.

5. Extract a security log from the Test Subject and using a **Text Editor**, identify the `FrameSequencePlayed` events associated with the above steps and:

- a. Confirm that all required elements have correctly formatted parameters as defined in [SMPTE-430-5]. Missing required elements or incorrect parameters shall be cause to fail this test.
- b. Confirm the presence of `FrameSequencePlayed` log records that contain `ContentAuthenticatorError` exceptions. Record any additional parameters associated with the exception. A missing `ContentAuthenticatorError` exception in any of the associated `FrameSequencePlayed` log records shall be cause to fail this test. Only for the operation associated with step 2, a correctly recorded `CPLCheck` log record with a `CertFormatError` exception is an allowable substitute for a `FrameSequencePlayed` log record to satisfy the requirements of this step of the test.

Supporting Materials

Reference Documents	DCI-DCSS, 9.4.3.5 SMPTE-429-7 SMPTE-430-1 SMPTE-430-2 SMPTE-430-5
Test Materials	<i>DCI 2K StEM (Encrypted)</i> <i>KDM with invalid ContentAuthenticator</i> <i>DCI Malformed Test 16: CPL signed with No Role Certificate (Encrypted)</i> <i>KDM for DCI Malformed Test 16: CPL signed with No Role Certificate (Encrypted)</i> <i>DCI Malformed Test 17: CPL signed with Bad Role Certificate (Encrypted)</i> <i>KDM for DCI Malformed Test 17: CPL signed with Bad Role Certificate (Encrypted)</i> <i>DCI Malformed Test 18: CPL signed with Extra Role Certificate (Encrypted)</i> <i>KDM for DCI Malformed Test 18: KDM for CPL signed with Extra Role Certificate (Encrypted)</i>

Consolidated Test Sequences

Sequence	Type	Measured Data
15.2. Integrated IMB Test Sequence	Pass/Fail	—
15.4. Integrated IMB Confidence Sequence	Pass/Fail	—
21.2. Integrated IMBO Test Sequence	Pass/Fail	—
21.4. Integrated IMBO Confidence Sequence	Pass/Fail	—

6.1.10. KDM Date Check

Objective

Verify that the Test Subject checks that the playout date is within the time period defined by the KDM `ContentKeysNotValidBefore` and `ContentKeysNotValidAfter` elements.

Procedures

1. Load the composition *DCI 2K StEM (Encrypted)* and KDM *KDM that has expired*, which contains a valid decryption keys, but the KDM has expired.
2. Attempt to play the *DCI 2K StEM (Encrypted)* composition and record the result. Verify that the composition cannot be played. Successful playout is cause to fail this test.
3. Load the composition *DCI 2K StEM (Encrypted)* and the KDM *KDM with future validity period*, which contains a valid decryption keys, but the KDM has is not yet valid.
4. Attempt to play the *DCI 2K StEM (Encrypted)* composition and record the result. Verify that the composition cannot be played. Successful playout is cause to fail this test.
5. Load the composition *DCI 2K StEM (Encrypted)* and KDM *KDM that has recently expired*, which contains a valid decryption keys, but the KDM has expired.
6. Attempt to play the *DCI 2K StEM (Encrypted)* composition and record the result. Verify that the composition cannot be played. Successful playout is cause to fail this test.
7. Load the composition *DCI 2K StEM (Encrypted)* and the KDM *KDM with future validity period*, which contains a valid decryption keys, but the KDM has is not yet valid.
8. Attempt to play the *DCI 2K StEM (Encrypted)* composition and record the result. Verify that the composition cannot be played. Successful playout is cause to fail this test.
9. Extract a security log from the Test Subject and using a **Text Editor**, identify the `FrameSequencePlayed` events associated with the above steps and:
 - a. Confirm that all required elements have correctly formatted parameters as defined in [SMPTE-430-5]. Missing required elements or incorrect parameters shall be cause to fail this test.
 - b. Confirm the presence of a `FrameSequencePlayed` log record that contains a `ValidityWindowError` exception. Record any additional parameters associated with the exception. A missing `ValidityWindowError` exception in any of the associated `FrameSequencePlayed` log records shall be cause to fail this test.

Supporting Materials

Reference Documents	DCI-DCSS, 9.8 SMPTE-430-1 SMPTE-430-5
----------------------------	---

Test Materials	<i>KDM with future validity period</i> <i>KDM that has recently expired</i> <i>KDM that has expired</i> <i>DCI 2K StEM (Encrypted)</i>
-----------------------	---

Consolidated Test Sequences

Sequence	Type	Measured Data
15.2. Integrated IMB Test Sequence	Pass/Fail	—
21.2. Integrated IMBO Test Sequence	Pass/Fail	—

6.1.11. KDM TDL Check

Objective

The following does not apply if a Special Auditorium Situation is enabled.

Verify that the Test Subject checks that the set of SPBs configured for playout is consistent with the TDL (AuthorizedDeviceInfo element) in the controlling KDM.

Procedures

If the Test Subject is a *Media Block that is a Companion SPB and is married (physically and electrically) to an Imaging Device SPB*, perform each of the following steps. Before each step, delete all KDMs residing in the Test Subject. After completing the steps, extract a security log from the Test Subject and using a **Text Editor**:

- Identify the `FrameSequencePlayed` record associated with the image track file produced during each step, and confirm that all required elements have correctly formatted parameters as defined in [SMPTE-430-5].
- If successful playback start is expected, confirm that the `FrameSequencePlayed` record contains a `Parameter` element with a `Name` equal to `DownstreamDevice` and a `Value` equal to the certificate thumbprint of the Imaging Device SPB.
- If failed playback start is expected, confirm that the `FrameSequencePlayed` record contains a `TDLException` exception. Record all parameters associated with the exception.

Failure to produce correct log records, including missing required elements or incorrect parameters, shall be cause to fail this test.

1. Load the *KDM with Assume Trust TDL Entry for 2K StEM (Encrypted)*, which is a KDM that carries only the "assume trust" certificate thumbprint. Attempt to play *DCI 2K StEM (Encrypted)* and record the result. If playback does not begin this is cause to fail this test.
2. Load the *KDM with Assume Trust and random TDL entries*, which is KDM with a TDL that carries the "assume trust" certificate thumbprint and a single, randomly generated device list entry. Attempt to play *DCI 2K StEM (Encrypted)* and record the result. Successful start of playback is cause to fail this test.
3. Load the *KDM with random TDL entry*, which contains a single, randomly generated device list entry. Attempt to play *DCI 2K StEM (Encrypted)* and record the result. Successful start of playback is cause to fail this test.

4. Load the *KDM with the SM alone on the TDL*, which is a KDM with a TDL that contains only the certificate thumbprint of the SM Certificate of the Test Subject. Attempt to play *DCI 2K StEM (Encrypted)* and record the result. Successful start of playback is cause to fail the test.

5. Load the *KDM with the Imaging Device alone on the TDL*, which is a KDM with a TDL that contains only the certificate thumbprint of the Imaging Device SPB certificate. Attempt to play *DCI 2K StEM (Encrypted)* and record the result. If playback does not begin this is cause to fail this test.

If the Test Subject is a *Media Block that is permanently married to a Imaging Device SPB*, perform each of the following steps. Before each step, delete all KDMs residing in the Test Subject. After completing the steps, extract a security log from the Test Subject and using a **Text Editor**:

- Identify the `FrameSequencePlayed` record associated with the image track file produced during each step, and confirm that all required elements have correctly formatted parameters as defined in [SMPTE-430-5].

- If successful playback start is expected, confirm that the `FrameSequencePlayed` record does not contain a `Parameter` element with a `Name` equal to `DownstreamDevice`.

- If failed playback start is expected, confirm that the `FrameSequencePlayed` record contains a `TDLException` exception. Record all parameters associated with the exception.

Failure to produce correct log records, including missing required elements or incorrect parameters, shall be cause to fail this test.

1. Load the *KDM with Assume Trust TDL Entry for 2K StEM (Encrypted)*, which is a KDM that carries only the "assume trust" certificate thumbprint. Attempt to play *DCI 2K StEM (Encrypted)* and record the result. If playback does not begin this is cause to fail this test.

2. Load the *KDM with random TDL entry*, which contains a single, randomly generated device list entry. Attempt to play *DCI 2K StEM (Encrypted)* and record the result. If playback does not begin this is cause to fail this test.

3. Load the *KDM with the SM alone on the TDL*, which is a KDM with a TDL that contains only the certificate thumbprint of the SM Certificate of the Test Subject. Attempt to play *DCI 2K StEM (Encrypted)* and record the result. If playback does not begin this is cause to fail this test.

Supporting Materials

Reference Documents	DCI-DCSS, 9.8, 9.4.3.5, 9.4.3.6.1, 9.4.3.6.5, 9.4.3.6.6 SMPTE-430-1 SMPTE-430-5
Test Materials	<i>KDM with Assume Trust and random TDL entries</i> <i>KDM with the SM alone on the TDL</i> <i>KDM with the Imaging Device alone on the TDL</i> <i>KDM with random TDL entry</i> <i>KDM with Assume Trust TDL Entry for 2K StEM (Encrypted)</i>

Consolidated Test Sequences

Sequence	Type	Measured Data
15.2. Integrated IMB Test Sequence	Pass/Fail	—
15.4. Integrated IMB Confidence Sequence	Pass/Fail	—
21.2. Integrated IMBO Test Sequence	Pass/Fail	—
21.4. Integrated IMBO Confidence Sequence	Pass/Fail	—

6.1.12. Maximum Number of DCP Keys

Objective

Verify that the system supports playback of two compositions with up to 256 different essence encryption keys each

Procedures

Note:

The KDMs specified to be used in this test additionally have one of each type of forensic marking keys FMIK and FMAK. Receiving devices shall process such keys in accordance with the individual implementation, in a manner that will not affect the requirements related to the maximum number of content keys (MDIK and MDAK).

Note:

The CPLStart and CPLend records are triggered by the first and last edit unit, respectively, of the CPL reproduced by the Test Subject. For example, in the case of an OMB with OBAE capability, the first and last edit units of the CPL are OBAE edit units, since picture edit units are not reproduced despite Main Picture assets being present in the CPL received by the OMB.

1. Load the compositions *128 Reel Composition, "A" Series* and *128 Reel Composition, "B" Series* on to the Test Subject.
2. Create a show that contains *128 Reel Composition, "A" Series* and *128 Reel Composition, "B" Series*. Each composition contains 128 reels of plaintext picture and sound.
3. Play the show. With an **Accurate Real-Time Clock**, note the UTC time at the moment playback started. Failure to play the complete show shall be cause to fail this test.
4. Extract a security log from the Test Subject that includes the range of time during which Step 3 was carried out
5. Using a **Text Editor**, locate the first CPLStart and last CPLend records that occurred after the time recorded in Step 3. Let *Plaintext Time* be the absolute difference between the TimeStamp values of the two records.
6. Load the compositions *128 Reel Composition, "A" Series (Encrypted)* and *128 Reel Composition, "B" Series (Encrypted)* on to the Test Subject.

7. Load the KDMs *KDM for 128 Reel Composition, "A" Series (Encrypted)* and *KDM for 128 Reel Composition, "B" Series (Encrypted)* on to the Test Subject.
8. Create a show that contains *128 Reel Composition, "A" Series (Encrypted)* and *128 Reel Composition, "B" Series (Encrypted)*. Each composition contains 128 reels of encrypted picture and sound.
9. Play the show. With an **Accurate Real-Time Clock**, note the UTC time at the moment playback started. Failure to play the complete show shall be cause to fail this test.
10. The presence of any observable artifacts in the reproduced picture and/or sound shall be cause to fail this test.
11. Extract a security log from the Test Subject that includes the range of time during which Step 9 was carried out.
12. Using a **Text Editor**, locate the first CPLStart and last CPLend records that occurred after the time recorded in Step 9. Let Ciphertext Time be the absolute difference between the TimeStamp values of the two records.
13. An absolute difference of more than 1 second between Ciphertext Time and Plaintext Time is cause to fail this test.

Supporting Materials

Reference Documents	DCI-DCSS, 9.7.7 SMPTE-430-1
Test Materials	<i>128 Reel Composition, "A" Series</i> <i>128 Reel Composition, "B" Series</i> <i>128 Reel Composition, "A" Series (Encrypted)</i> <i>128 Reel Composition, "B" Series (Encrypted)</i> <i>KDM for 128 Reel Composition, "A" Series (Encrypted)</i> <i>KDM for 128 Reel Composition, "B" Series (Encrypted)</i>

Consolidated Test Sequences

Sequence	Type	Measured Data
15.2. Integrated IMB Test Sequence	Pass/Fail	—
21.2. Integrated IMBO Test Sequence	Pass/Fail	—

6.1.13. CPL Id Check

Objective

Verify that the Test Subject checks that the KDM <CompositionPlaylistId> element matches the value of the CompositionPlaylistID field of KDM CipherData structure as specified in [SMPTE-430-1]

Procedures

1. Load *DCI 2K StEM (Encrypted)*.
2. load *KDM with bad CipherData CompositionPlaylistId value*, a KDM in which (i) the value of the CompositionPlaylistID field of the CipherData structure does not match the value of the <Id> element of *DCI 2K StEM (Encrypted)* and (ii) the value of the <CompositionPlaylistId> element matches the value of the CompositionPlaylist <Id> element of *DCI 2K StEM (Encrypted)*. Attempt to play *DCI 2K StEM (Encrypted)*. Successful playback is cause to fail this test.
3. Delete *KDM with bad CipherData CompositionPlaylistId value*.
4. Load *KDM with bad CompositionPlaylistId value*, a KDM in which (i) the value of the CompositionPlaylistID field of the CipherData structure matches the value of the <Id> element of *DCI 2K StEM (Encrypted)* and (ii) the value of the <CompositionPlaylistId> element does not match the value of the CompositionPlaylist <Id> element in *DCI 2K StEM (Encrypted)*. Attempt to play *DCI 2K StEM (Encrypted)*. Successful playback is cause to fail this test.
5. Extract a security log from the Test Subject and using a **Text Editor**, identify the KDMKeysReceived events associated with the above steps and:
 - a. Confirm that all required elements have correctly formatted parameters as defined in [SMPTE-430-5]. Missing required elements or incorrect parameters shall be cause to fail this test.
 - b. Confirm the presence of a KDMFormatError exception in the KDMKeysReceived log record. Record any additional parameters associated with the exception. A missing KDMFormatError exception in any of the associated KDMKeysReceived log records shall be cause to fail this test.

Supporting Materials

Reference Documents	DCI-DCSS, 9.8, 9.4.3.5 SMPTE-430-1 SMPTE-430-3 SMPTE-430-5
Test Materials	<i>KDM with bad CipherData CompositionPlaylistId value</i> <i>KDM with bad CompositionPlaylistId value</i> <i>DCI 2K StEM (Encrypted)</i>

Consolidated Test Sequences

Sequence	Type	Measured Data
15.2. Integrated IMB Test Sequence	Pass/Fail	—
21.2. Integrated IMBO Test Sequence	Pass/Fail	—

6.1.14. CPL Id Check (OBAE)

Objective

Verify that the Test Subject checks that the KDM <CompositionPlaylistId> element matches the value of the CompositionPlaylistId field of KDM CipherData structure as specified in [SMPTE-430-1] .

Procedures

Note:

If the Test Subject is an OMB, the KDM targeting the associated IMB is valid, i.e. it is an instance of *KDM for 2K StEM (Encrypted) (OBAE)*.

1. Load *DCI 2K StEM (OBAE) (Encrypted)*.
2. Load *KDM with bad CipherData CompositionPlaylistId value (OBAE)*, a KDM in which (i) the value of the CompositionPlaylistId field of the CipherData structure does not match the value of the <Id> element of *DCI 2K StEM (OBAE) (Encrypted)* and (ii) the value of the <CompositionPlaylistId> element matches the value of the CompositionPlaylist <Id> element of *DCI 2K StEM (OBAE) (Encrypted)*. Attempt to play *DCI 2K StEM (OBAE) (Encrypted)*. Successful playback is cause to fail this test.
3. Delete *KDM with bad CipherData CompositionPlaylistId value (OBAE)*.
4. Load *KDM with bad CompositionPlaylistId value (OBAE)*, a KDM in which (i) the value of the CompositionPlaylistId field of the CipherData structure matches the value of the <Id> element of *DCI 2K StEM (OBAE) (Encrypted)* and (ii) the value of the <CompositionPlaylistId> element does not match the value of the CompositionPlaylist <Id> element in *DCI 2K StEM (OBAE) (Encrypted)*. Attempt to play *DCI 2K StEM (OBAE) (Encrypted)*. Successful playback is cause to fail this test.
5. Extract a security log from the Test Subject and using a **Text Editor**, identify the KDMKeysReceived events associated with the above steps and:
 - a. Confirm that all required elements have correctly formatted parameters as defined in [SMPTE-430-5]. Missing required elements or incorrect parameters shall be cause to fail this test.
 - b. Confirm the presence of a KDMFormatError exception in the KDMKeysReceived log record. Record any additional parameters associated with the exception. A missing KDMFormatError exception in any of the associated KDMKeysReceived log records shall be cause to fail this test.

Supporting Materials

Reference Documents	DCI-DCSS, 9.8, 9.4.3.5 SMPTE-430-1 SMPTE-430-3 SMPTE-430-5
Test Materials	<i>KDM with bad CipherData CompositionPlaylistId value (OBAE)</i> <i>KDM with bad CompositionPlaylistId value (OBAE)</i> <i>DCI 2K StEM (OBAE) (Encrypted)</i>

Consolidated Test Sequences

Sequence	Type	Measured Data
20.2. OMB Test Sequence	Pass/Fail	—
21.2. Integrated IMBO Test Sequence	Pass/Fail	—

6.1.15. Restriction of Playback in Absence of Integrity Pack Metadata

Objective

Verify that playback of encrypted content is disallowed or terminated when integrity pack metadata is missing.

Procedures

For each of the rows of [Table 6.1](#), perform the following steps in order:

1. If the Test Subject is not one of the *Target Test Subject(s)*, skip the row.
2. Attempt playback of the *Malformed Composition* from its start using the associated *KDM*, and, with an **Accurate Real-Time Clock**, note the UTC time of the attempt.
3. Confirm that either:
 - a. no part of the *Malformed Composition* is played; or
 - b. playback of the *Malformed Composition* stops no later than 61 seconds after playback starts.
4. Extract a security log from the Test Subject that includes the range of time during which the above Steps were carried out and, using a **Text Editor**, confirm that:
 - a. all required elements of the security log have correctly formatted parameters as defined in [SMPTE-430-5].
 - b. there is exactly one `FrameSequencePlayed` log record for the associated *Malformed Track File* and that the record contains a single instance of the specified *Exception Token*.
 - c. there is no `PlayoutComplete` event associated with the playback.

Failure of any part of any of the steps above shall be cause to fail this test.

Table 6.1. List of Compositions with missing integrity pack items

Malformed Composition, Malformed Composition KDM and Malformed Track File	Exception Token	Target Test Subject(s)
m25_integrity_pict_mic_ct.cpl.xml m25_integrity_pict_mic_ct.kdm.xml m25_integrity_pict_mic_j2c_ct.mxf	FrameMICError	IMB, IMBO
m27_integrity_pict_tfid_ct.cpl.xml m27_integrity_pict_tfid_ct.cpl.xml m27_integrity_pict_tfid_j2c_ct.mxf	TrackFileIDError	IMB, IMBO
m26_integrity_pict_snum_ct.cpl.xml		

m26_integrity_pict_snum_ct.kdm.xml m26_integrity_pict_snum_j2c_ct.mxf	FrameSequenceError	IMB, IMBO
m28_integrity_snd_mic_ct.cpl.xml m28_integrity_snd_mic_ct.kdm.xml m28_integrity_snd_mic_pcm_ct.mxf	FrameMICErrror	IMB, IMBO
m30_integrity_snd_tfid_ct.cpl.xml m30_integrity_snd_tfid_ct.kdm.xml m30_integrity_snd_tfid_pcm_ct.mxf	TrackFileIDError	IMB, IMBO
m29_integrity_snd_snum_ct.cpl.xml m29_integrity_snd_snum_ct.kdm.xml m29_integrity_snd_snum_pcm_ct.mxf	FrameSequenceError	IMB, IMBO
m20_integrity_obae_ms_mic_ct.cpl.xml m20_integrity_obae_ms_mic_ct.kdm.xml m20_integrity_obae_ms_mic_pcm_ct.mxf	FrameMICErrror	IMB, IMBO
m22_integrity_obae_ms_tfid_ct.cpl.xml m22_integrity_obae_ms_tfid_ct.kdm.xml m22_integrity_obae_ms_tfid_pcm_ct.mxf	TrackFileIDError	IMB, IMBO
m21_integrity_obae_ms_snum_ct.cpl.xml m21_integrity_obae_ms_snum_ct.kdm.xml m21_integrity_obae_ms_snum_pcm_ct.mxf	FrameSequenceError	IMB, IMBO
m19_integrity_obae_mic_ct.cpl.xml m19_integrity_obae_mic_ct.kdm.xml m19_integrity_obae_mic_obae_ct.mxf	FrameMICErrror	OMB, IMBO
m24_integrity_obae_tfid_ct.cpl.xml m24_integrity_obae_tfid_ct.kdm.xml m24_integrity_obae_tfid_obae_ct.mxf	TrackFileIDError	OMB, IMBO
m23_integrity_obae_snum_ct.cpl.xml m23_integrity_obae_snum_ct.kdm.xml m23_integrity_obae_snum_obae_ct.mxf	FrameSequenceError	OMB, IMBO

Supporting Materials

Reference Documents	DCI-DCSS, 9.4.3.5, 9.4.3.6.4 SMPTE-429-6 SMPTE-430-5
Test Equipment	Accurate Real-Time Clock Text Editor
Test Materials	<i>M25 Composition with Malformed Integrity Pack: Missing MIC item (Picture) (Encrypted)</i> <i>KDM for M25 Composition with Malformed Integrity Pack: Missing MIC item (Picture) (Encrypted)</i> <i>M25 Picture Track File with Malformed Integrity Pack: Missing MIC item (Encrypted)</i> <i>M27 Composition with Malformed Integrity Pack: Missing TrackFileID item (Picture) (Encrypted)</i> <i>KDM for M27 Composition with Malformed Integrity Pack: Missing TrackFileID item (Picture) (Encrypted)</i>

M27 Picture Track File with Malformed Integrity Pack: Missing TrackFileID item (Encrypted)

M26 Composition with Malformed Integrity Pack: Missing SequenceNumber item (Picture) (Encrypted)

KDM for M26 Composition with Malformed Integrity Pack: Missing SequenceNumber item (Picture) (Encrypted)

M26 Picture Track File with Malformed Integrity Pack: Missing SequenceNumber item (Encrypted)

M28 Composition with Malformed Integrity Pack: Missing MIC item (PCM) (Encrypted)

KDM for M28 Composition with Malformed Integrity Pack: Missing MIC item (PCM) (Encrypted)

M28 Sound Track File with Malformed Integrity Pack: Missing MIC item (Encrypted)

M30 Composition with Malformed Integrity Pack: Missing TrackFileID item (PCM) (Encrypted)

KDM for M30 Composition with Malformed Integrity Pack: Missing TrackFileID item (PCM) (Encrypted)

M30 Sound Track File with Malformed Integrity Pack: Missing TrackFileID item (Encrypted)

M29 Composition with Malformed Integrity Pack: Missing SequenceNumber item (PCM) (Encrypted)

KDM for M29 Composition with Malformed Integrity Pack: Missing SequenceNumber item (PCM) (Encrypted)

M29 Sound Track File with Malformed Integrity Pack: Missing SequenceNumber item (Encrypted)

M20 Composition with Malformed Integrity Pack: Missing MIC item (OBAE Main Sound) (Encrypted)

KDM for M20 Composition with Malformed Integrity Pack: Missing MIC item (OBAE Main Sound) (Encrypted)

M20 Sound Track File with Malformed Integrity Pack: Missing MIC item (OBAE) (Encrypted)

M22 Composition with Malformed Integrity Pack: Missing TrackFileID item (OBAE Main Sound) (Encrypted)

KDM for M22 Composition with Malformed Integrity Pack: Missing TrackFileID item (OBAE Main Sound) (Encrypted)

M22 Sound Track File with Malformed Integrity Pack: Missing TrackFileID item (OBAE) (Encrypted)

M21 Composition with Malformed Integrity Pack: Missing SequenceNumber item (OBAE Main Sound) (Encrypted)

KDM for M21 Composition with Malformed Integrity Pack: Missing SequenceNumber item (OBAE Main Sound) (Encrypted)

M21 Sound Track File with Malformed Integrity Pack: Missing SequenceNumber item (OBAE) (Encrypted)

M19 Composition with Malformed Integrity Pack: Missing MIC item (OBAE) (Encrypted)

KDM for M19 Composition with Malformed Integrity Pack: Missing MIC item (OBAE) (Encrypted)

M19 OBAE Track File with Malformed Integrity Pack: Missing MIC item (Encrypted)

M24 Composition with Malformed Integrity Pack: Missing TrackFileID item (OBAE) (Encrypted)

KDM for M24 Composition with Malformed Integrity Pack: Missing TrackFileID item (OBAE) (Encrypted)

M24 OBAE Track File with Malformed Integrity Pack: Missing TrackFileID item (OBAE) (Encrypted)

M23 Composition with Malformed Integrity Pack: Missing SequenceNumber item (OBAE) (Encrypted)

KDM for M23 Composition with Malformed Integrity Pack: Missing SequenceNumber item (OBAE) (Encrypted)

M23 OBAE Track File with Malformed Integrity Pack: Missing SequenceNumber item (Encrypted)

Consolidated Test Sequences

Sequence	Type	Measured Data
15.2. Integrated IMB Test Sequence	Pass/Fail	—
20.2. OMB Test Sequence	Pass/Fail	—
21.2. Integrated IMBO Test Sequence	Pass/Fail	—

6.1.16. Restriction of Keying to MDEK Type (OBAE)

Objective

Verify that a key is not issued to an OBAE media decryptor if the KeyType of the key is not equal to "MDEK".

Procedures

1. Load *KDM with mismatched KeyType value (OBAE)*.
2. Load and attempt to play the composition *DCI 2K StEM (OBAE) (Encrypted)*. Successful playback shall be cause to fail this test.
3. Extract a security log from the Test Subject and using a **Text Editor**, identify the events associated with the operation and:
 - a. Confirm that all required elements have correctly formatted parameters as defined in [SMPTE-430-5]. Missing required elements or incorrect parameters shall be cause to fail this test.
 - b. Confirm the presence of an associated FrameSequencePlayed log record that contains a KeyTypeError exception. Record any additional parameters associated with the exception. Failure to produce correct log records shall be cause to fail this test.

Supporting Materials

Reference Documents	DCI-DCSS, 9.4.3.5, 9.4.3.6.4
----------------------------	------------------------------

Test Equipment	SMPTE-430-1
	SMPTE-430-5
Test Materials	Text Editor
	<i>KDM with mismatched KeyType value (OBAE)</i> <i>DCI 2K StEM (OBAE) (Encrypted)</i>

Consolidated Test Sequences

Sequence	Type	Measured Data
20.2. OMB Test Sequence	Pass/Fail	—
21.2. Integrated IMBO Test Sequence	Pass/Fail	—

6.1.17. OBAE Integrity Checking

Objective

Verify that, for OBAE Track Files, the SM detects and logs deviations in the:

- Sequence Number item of the Encrypted Triplet
- TrackFile ID item of the Encrypted Triplet
- Check Value of the Encrypted Source Value
- MIC item of the Encrypted Triplet

Procedures

1. Play back the composition *M40 OBAE DCP with Frame-out-of-order error (Encrypted)*, keyed with *KDM for M40 OBAE DCP with Frame-out-of-order error (Encrypted)*. Extract a security log from the Test Subject and using a **Text Editor**, identify the events associated with the playback and:
 - a. Confirm that all required elements have correctly formatted parameters as defined in [SMPTE-430-5]. Missing required elements or incorrect parameters shall be cause to fail this test.
 - b. Confirm the presence of a `FrameSequenceError` exception in the `FrameSequencePlayed` log record for the OBAE track file. Record any additional parameters associated with the exception.
2. Play back the composition *M41 OBAE DCP with an incorrect TrackFile ID (Encrypted)*, keyed with *KDM for M41 OBAE DCP with an incorrect TrackFile ID (Encrypted)*. Extract a security log from the Test Subject and using a **Text Editor**, identify the events associated with the playback and:
 - a. Confirm that all required elements have correctly formatted parameters as defined in [SMPTE-430-5]. Missing required elements or incorrect parameters shall be cause to fail this test.
 - b. Confirm the presence of a `TrackFileIDError` exception in the `FrameSequencePlayed` log record for the OBAE track file. Record any additional parameters associated with the exception.

3. Play back the composition *DCI 2K Sync Test with MIC Key (OBAE) (Encrypted)*, keyed with *KDM with invalid MIC Key for DCI 2K Sync Test with MIC Key (OBAE) (Encrypted)*. Extract a security log from the Test Subject and using a **Text Editor**, identify the events associated with the playback and:
 - a. Confirm that all required elements have correctly formatted parameters as defined in [SMPTE-430-5]. Missing required elements or incorrect parameters shall be cause to fail this test.
 - b. Confirm the presence of a `FrameMICError` exception in the `FrameSequencePlayed` log record for the OBAE track file. Record any additional parameters associated with the exception.

4. Play back the composition *DCI 2K Sync Test (OBAE) (Encrypted)*, keyed with *KDM with MIC Key for DCI 2K Sync Test (OBAE) (Encrypted)*. Extract a security log from the Test Subject and using a **Text Editor**, identify the events associated with the playback and:
 - a. Confirm that all required elements have correctly formatted parameters as defined in [SMPTE-430-5]. Missing required elements or incorrect parameters shall be cause to fail this test.
 - b. Confirm the presence of a `FrameMICError` exception in the `FrameSequencePlayed` log record for the OBAE track file. Record any additional parameters associated with the exception.

5. Play back the composition *M44 OBAE DCP with HMAC error in MXF Track File (Encrypted)*, keyed with *KDM for M44 OBAE DCP with HMAC error in MXF Track File (Encrypted)*. Extract a security log from the Test Subject and using a **Text Editor**, identify the events associated with the playback and:
 - a. Confirm that all required elements have correctly formatted parameters as defined in [SMPTE-430-5]. Missing required elements or incorrect parameters shall be cause to fail this test.
 - b. Confirm that there is no `FrameMICError` exception in the `FrameSequencePlayed` log record for the OBAE track file.

6. Play back the composition *M43 OBAE DCP with Check Value error in MXF Track File (Encrypted)*, keyed with *KDM for M43 OBAE DCP with Check Value error in MXF Track File (Encrypted)*. Extract a security log from the Test Subject and using a **Text Editor**, identify the events associated with the playback and:
 - a. Confirm that all required elements have correctly formatted parameters as defined in [SMPTE-430-5]. Missing required elements or incorrect parameters shall be cause to fail this test.
 - b. Confirm the presence of a `CheckValueError` exception in the `FrameSequencePlayed` log record for the OBAE track file. Record any additional parameters associated with the exception.

Failure of any of the above conditions is cause to fail this test.

Supporting Materials

Reference Documents	DCI-DCSS, 9.4.3.5, 9.4.3.6.4
Test Equipment	Text Editor

Test Materials	<i>DCI 2K Sync Test (OBAE) (Encrypted)</i> <i>M40 OBAE DCP with Frame-out-of-order error (Encrypted)</i> <i>M41 OBAE DCP with an incorrect TrackFile ID (Encrypted)</i> <i>DCI 2K Sync Test with MIC Key (OBAE) (Encrypted)</i> <i>M43 OBAE DCP with Check Value error in MXF Track File (Encrypted)</i> <i>M44 OBAE DCP with HMAC value error in MXF Track File (Encrypted)</i> <i>KDM for M40 OBAE DCP with Frame-out-of-order error (Encrypted)</i> <i>KDM for M41 OBAE DCP with an incorrect TrackFile ID (Encrypted)</i> <i>KDM for M43 OBAE DCP with Check Value error in MXF Track File (Encrypted)</i> <i>KDM with invalid MIC Key for DCI 2K Sync Test with MIC Key (OBAE) (Encrypted)</i> <i>KDM with MIC Key for DCI 2K Sync Test (OBAE) (Encrypted)</i> <i>KDM for M44 OBAE DCP with HMAC Value error in MXF Track File (Encrypted)</i>
-----------------------	--

Consolidated Test Sequences

Sequence	Type	Measured Data
20.2. OMB Test Sequence	Pass/Fail	—
21.2. Integrated IMBO Test Sequence	Pass/Fail	—

6.1.18. Content Key Extension, End of Engagement (OBAE)

Objective

Verify that, to avoid end of engagement issues, OBAE composition playout can extend beyond the end of the KDM's playout time window by a maximum of 6 hours as long as playback is started within the KDM playout time window.

Procedures

Note:

This test requires KDMs that contain `ContentKeysNotValidAfter` elements set to a time in the near future. It is recommended that fresh KDMs be generated that will expire 30-60 minutes after beginning the test procedures. Refer to information provided in the relevant step to ensure that the applicable KDM is being used at the appropriate absolute time the step of the test is carried out.

Note:

The Test Operator is required to take into account any timezone offsets that may apply to the locality of the Test Subject and the representation of the `ContentKeysNotValidAfter` element of the KDM. For clarity it is recommended that a common representation be used.

Note:

The Security Manager's (SM) clock must be accurately set, to the extent possible, for successful execution of this test.

Note:

the Test Subject. For example, in the case of an OMB with OBAE capability, the first and last edit units of the CPL are OBAE edit units, since picture edit units are not reproduced despite Main Picture assets being present in the CPL received by the OMB.

1. Using a **Text Editor**, open the KDM *KDM for Past Time Window Extension (OBAE) (Encrypted)* and note the value of the timestamp contained in the <ContentKeysNotValidAfter> element (i.e. the KDM's end of validity timestamp).

Note: Steps 2 and 3 must be commenced before the time recorded in this step.

2. Load the composition *End of Engagement - Past Time Window Extension (OBAE) (Encrypted)*, keyed with *KDM for Past Time Window Extension (OBAE) (Encrypted)*. The composition is 6 hours and 11 minutes in length.

3. Within 5 minutes prior to the timestamp recorded in step 1, attempt to start playing *End of Engagement - Past Time Window Extension (OBAE) (Encrypted)*. Because the complete show extends beyond the 6 hours end of engagement extension window, the composition should not start playback. If the composition starts to playback, this is cause to fail this test.

4. Using a **Text Editor**, open the KDM *KDM for Within Time Window Extension (OBAE) (Encrypted)* and note the value of the timestamp contained in the <ContentKeysNotValidAfter> element (i.e. the KDM's end of validity timestamp). *Note: Steps 5 and 6 must be commenced before the time recorded in this step.*

5. Load the composition *End of Engagement - Within Time Window Extension (OBAE) (Encrypted)*, keyed with *KDM for Within Time Window Extension (OBAE) (Encrypted)*. The composition has a duration of 5 hours, 59 minutes and 30 seconds.

6. Within 5 minutes prior to the timestamp recorded in step 4, attempt to start playing *End of Engagement - Within Time Window Extension (OBAE) (Encrypted)*. The composition should start to playback and continue playing in its entirety. If the show fails to start or fails to playout completely, this is cause to fail this test.

*Note: The test operator does not have to be present for the entire playback. Sufficient proof of successful playback can be observed by examining the security log for complete *FrameSequencePlayed*, *CPLEnd* and *PlayoutComplete* events.*

Supporting Materials

Reference Documents	DCI-DCSS, 9.4.3.5
Test Equipment	Text Editor
Test Materials	<i>End of Engagement - Past Time Window Extension (OBAE) (Encrypted)</i> <i>End of Engagement - Within Time Window Extension (OBAE) (Encrypted)</i> <i>KDM for Past Time Window Extension (OBAE) (Encrypted)</i> <i>KDM for Within Time Window Extension (OBAE) (Encrypted)</i>

Consolidated Test Sequences

Sequence	Type	Measured Data
20.2. OMB Test Sequence	Pass/Fail	—
20.4. OMB Confidence Sequence	Pass/Fail	—

6.1.19. Plurality of Media Block Identity Certificates

Objective

Verify that the Media Block supports one published identity certificate and one reserved identity certificate.

Procedures

Note:

For simplicity, this test procedure uses same OBAE content for all Media Blocks (IMB, integrated IMB, IMBO and OMB) since the objective is to merely to determine whether playback occurs, and not whether a complete presentation occurred.

1. Obtain, from the manufacturer, the published and reserved identity certificates of the Test Subject, as defined in Section 9.5.1.3 of [DCI-DCSS].
2. Verify that the roles listed in the published identity certificate obtained in step 1 include SM but not RES ([SMPTE-430-2] specifies roles found in certificates). Failure of this verification is cause to fail the test.
3. Verify that the roles listed in the reserved identity certificate obtained in step 1 includes SM and RES. Failure of this verification is cause to fail the test.
4. Load *DCI 2K StEM (OBAE) (Encrypted)*.
5. Load *KDM for 2K StEM (Encrypted) (OBAE)* targeted at the published identity certificate obtained in step 1.
6. Playback *DCI 2K StEM (OBAE) (Encrypted)*. Failure to playback is cause to fail this test.
7. Delete *KDM for 2K StEM (Encrypted) (OBAE)* loaded in step 5.
8. Load *KDM for 2K StEM (Encrypted) (OBAE)* targeted at the reserved identity certificate obtained in step 1.
9. Playback *DCI 2K StEM (OBAE) (Encrypted)*. Failure to playback is cause to fail this test.

Supporting Materials

Reference Documents	DCI-DCSS, 9.5.1.3 SMPTE-430-2
Test Materials	<i>KDM for 2K StEM (Encrypted) (OBAE)</i> <i>DCI 2K StEM (OBAE) (Encrypted)</i>

Consolidated Test Sequences

Sequence	Type	Measured Data
15.2. Integrated IMB Test Sequence	Pass/Fail	—
20.2. OMB Test Sequence	Pass/Fail	—
21.2. Integrated IMBO Test Sequence	Pass/Fail	—

6.1.20. Validity of SPB Certificates

Objective

Verify that the certificates of the SPB are valid.

Procedures

1. Obtain, from the manufacturer, (i) the one or more X.509 digital leaf certificates associated with the Test Subject and (ii) the complete chain of signer certificates for each of the one or two leaf certificate, up to and including the manufacturer's self-signed root certificate.
2. For each certificate, perform the following tests:
 - o 2.1.1. Basic Certificate Structure
 - o 2.1.2. SignatureAlgorithm Fields
 - o 2.1.3. SignatureValue Field
 - o 2.1.4. SerialNumber Field
 - o 2.1.5. SubjectPublicKeyInfo Field
 - o 2.1.6. Deleted Section
 - o 2.1.7. Validity Field
 - o 2.1.8. AuthorityKeyIdentifier Field
 - o 2.1.9. KeyUsage Field
 - o 2.1.10. Basic Constraints Field
 - o 2.1.11. Public Key Thumbprint
 - o 2.1.12. Organization Name Field
 - o 2.1.13. OrganizationUnitName Field
 - o 2.1.14. Entity Name and Roles Field

- o 2.1.15. Unrecognized Extensions
- o 2.1.16. Signature Validation

3. For the complete chain of signer certificates, perform 2.1.17. Certificate Chains

Failure of any of these above conditions is cause to fail this test.

Supporting Materials

Reference Documents	DCI-DCSS, 9.5.1 SMPTE-430-2
Test Equipment	Network Analyzer openssl

Consolidated Test Sequences

Sequence	Type	Measured Data
15.2. Integrated IMB Test Sequence	Pass/Fail	—
15.4. Integrated IMB Confidence Sequence	Pass/Fail	—
20.2. OMB Test Sequence	Pass/Fail	—
21.2. Integrated IMBO Test Sequence	Pass/Fail	—
20.4. OMB Confidence Sequence	Pass/Fail	—
20.4. OMB Confidence Sequence	Pass/Fail	—
21.4. Integrated IMBO Confidence Sequence	Pass/Fail	—
24.2. SDR Projector Test Sequence	Pass/Fail	—
24.4. SDR Projector Confidence Sequence	Pass/Fail	—
26.2. HDR Direct View Display Test Sequence	Pass/Fail	—
26.4. HDR Direct View Display Confidence Sequence	Pass/Fail	—
27.2. SDR Direct View Display Test Sequence	Pass/Fail	—
27.4. SDR Direct View Display Confidence Sequence	Pass/Fail	—
28.2. HDR Projector Test Sequence	Pass/Fail	—
28.4. HDR Projector Confidence Sequence	Pass/Fail	—

6.1.21. Maximum Number of DCP Keys (OBAE)

Objective

Verify that the system supports playback of two compositions with up to 256 different essence encryption keys each

Procedures

Note:

The KDMs specified to be used in this test additionally have one of each type of forensic marking keys FMIK and

FMAK. Receiving devices shall process such keys in accordance with the individual implementation, in a manner that will not affect the requirements related to the maximum number of content keys (MDIK and MDAK).

Note:

The CPLStart and CPEnd records are triggered by the first and last edit unit, respectively, of the CPL reproduced by the Test Subject. For example, in the case of an OMB with OBAE capability, the first and last edit units of the CPL are OBAE edit units, since picture edit units are not reproduced despite Main Picture assets being present in the CPL received by the OMB.

1. Load the compositions *128 Reel Composition, "A" Series (OBAE)* and *128 Reel Composition, "B" Series (OBAE)* on to the Test Subject.
2. Create a show that contains *128 Reel Composition, "A" Series (OBAE)* and *128 Reel Composition, "B" Series (OBAE)*. Each composition contains 128 reels of plaintext content.
3. Play the show. With an **Accurate Real-Time Clock**, note the UTC time at the moment playback started. Failure to play the complete show shall be cause to fail this test.
4. Extract a security log from the Test Subject that includes the range of time during which Step 3 was carried out
5. Using a **Text Editor**, locate the first CPLStart and last CPEnd records that occurred after the time recorded in Step 3. Let *Plaintext Time* be the absolute difference between the *TimeStamp* values of the two records.
6. Load the compositions *128 Reel Composition, "A" Series (OBAE) (Encrypted)* and *128 Reel Composition, "B" Series (OBAE) (Encrypted)* on to the Test Subject.
7. Load the KDMs *KDM for 128 Reel Composition, "A" Series (OBAE) (Encrypted)* and *KDM for 128 Reel Composition, "B" Series (OBAE) (Encrypted)* on to the Test Subject.
8. Create a show that contains *128 Reel Composition, "A" Series (OBAE) (Encrypted)* and *128 Reel Composition, "B" Series (OBAE) (Encrypted)*. Each composition contains 128 reels of encrypted content where 256 distinct cryptographic keys are used.
9. Play the show. With an **Accurate Real-Time Clock**, note the UTC time at the moment playback started. Failure to play the complete show shall be cause to fail this test.
10. The presence of any observable artifacts in the reproduced picture and/or sound shall be cause to fail this test.
11. Extract a security log from the Test Subject that includes the range of time during which Step 9 was carried out.
12. Using a **Text Editor**, locate the first CPLStart and last CPEnd records that occurred after the time recorded in Step 9. Let *Ciphertext Time* be the absolute difference between the *TimeStamp* values of the two records.

13. An absolute difference of more than 1 second between Ciphertext Time and Plaintext Time is cause to fail this test.

Supporting Materials

Reference Documents	DCI-DCSS, 9.7.7 SMPTE-430-1
Test Materials	128 Reel Composition, "A" Series (OBAE) 128 Reel Composition, "B" Series (OBAE) 128 Reel Composition, "A" Series (OBAE) (Encrypted) 128 Reel Composition, "B" Series (OBAE) (Encrypted) KDM for 128 Reel Composition, "A" Series (OBAE) (Encrypted) KDM for 128 Reel Composition, "B" Series (OBAE) (Encrypted)

Consolidated Test Sequences

Sequence	Type	Measured Data
20.2. OMB Test Sequence	Pass/Fail	—
21.2. Integrated IMBO Test Sequence	Pass/Fail	—

6.1.22. Restriction of Keying to Valid CPLs (OBAE)

Objective

Verify that the OBAE-capable SM validates CPLs and logs results as a prerequisite to preparing the suite for the associated composition playback.

Procedures

1. Supply the CPL *DCI Malformed Test 6b: CPL with incorrect track file hashes (OBAE) (Encrypted)*, keyed with *KDM for DCI Malformed Test 6b: CPL with incorrect track file hashes (OBAE) (Encrypted)*, to the SM. Verify that the SM rejects the CPL. If the SM accepts the CPL, this is cause to fail this test.
2. Attempt to start playback and verify that it is not possible. If playback starts, this is cause to fail this test.
3. Extract a security log from the Test Subject and using a **Text Editor**, identify the CPLCheck event associated with the above operation and:
 - a. Confirm that all required elements have correctly formatted parameters as defined in [SMPTE-430-5]. Verify that the `contentId` element contains the `Id` of the CPL. Verify that the value of the `SignerID` parameter contains the Certificate Thumbprint of the certificate used to sign the CPL. Verify that `ReferencedIDs` element contains a `CompositionID` parameter with a value that is the `Id` of the CPL. Missing required elements or incorrect parameters shall be cause to fail this test.
 - b. Confirm the presence of a `AssetHashError` exception in the CPLCheck log record. Record any additional parameters associated with the exception. A missing `AssetHashError` exception shall be cause to fail this test.

4. Supply the CPL *DCI Malformed Test 7b: CPL with an Invalid Signature (OBAE) (Encrypted)*, keyed with KDM for DCI Malformed Test 7b: *CPL with an Invalid Signature (OBAE) (Encrypted)* to the SM. Verify that the SM rejects the CPL. If the SM accepts the CPL, this is cause to fail this test.
5. Attempt to start playback and verify that it is not possible. If playback starts, this is cause to fail this test.
6. Extract a security log from the Test Subject and using a **Text Editor**, identify the CPLCheck event associated with the above operation and:
 - a. Confirm that all required elements have correctly formatted parameters as defined in [SMPTE-430-5]. Verify that the `contentId` element contains the `Id` of the CPL. Verify that `ReferencedIDs` element contains a `CompositionID` parameter with a value that is the `Id` of the CPL. Missing required elements or incorrect parameters shall be cause to fail this test.
 - b. Confirm the presence of a `SignatureError` exception in the CPLCheck log record. Record any additional parameters associated with the exception. A missing `SignatureError` exception shall be cause to fail this test.
7. Supply the CPL *DCI Malformed Test 13b: CPL that references a non-existent track file (OBAE) (Encrypted)*, keyed with KDM for DCI Malformed Test 13b: *CPL that references a non-existent track file (OBAE) (Encrypted)* to the SM. Verify that the SM rejects the CPL. If the SM accepts the CPL, this is cause to fail this test.
8. Attempt to start playback and verify that it is not possible. If playback starts, this is cause to fail this test.
9. Extract a security log from the Test Subject and using a **Text Editor**, identify the CPLCheck event associated with the above operation and:
 - a. Confirm that all required elements have correctly formatted parameters as defined in [SMPTE-430-5]. Verify that the `contentId` element contains the `Id` of the CPL. Verify that the value of the `SignerID` parameter contains the Certificate Thumbprint of the certificate used to sign the CPL. Verify that `ReferencedIDs` element contains a `CompositionID` parameter with a value that is the `Id` of the CPL. Missing required elements or incorrect parameters shall be cause to fail this test.
 - b. Confirm the presence of a `AssetMissingError` exception in the CPLCheck log record. Record any additional parameters associated with the exception. A missing `AssetMissingError` exception shall be cause to fail this test.
10. Supply the CPL *DCI Malformed Test 14b: CPL that does not conform to ST 429-7 (OBAE) (Encrypted)*, keyed with KDM for DCI Malformed Test 14b: *CPL that does not conform to ST 429-7 (OBAE) (Encrypted)* to the SM. Verify that the SM rejects the CPL. If the SM accepts the CPL, this is cause to fail this test.
11. Attempt to start playback and verify that it is not possible. If playback starts, this is cause to fail this test.
12. Extract a security log from the Test Subject and using a **Text Editor**, identify the CPLCheck event associated with the above operation and:

- a. Confirm that all required elements have correctly formatted parameters as defined in [SMPTE-430-5]. Missing required elements or incorrect parameters shall be cause to fail this test.
 - b. Confirm the presence of a `CPLFormatError` exception in the `CPLCheck` log record. Record any additional parameters associated with the exception. A missing `CPLFormatError` exception shall be cause to fail this test.
13. Supply the *CPL DCI Malformed Test 15b: CPL signed by a certificate not conforming to ST 430-2 (OBAE) (Encrypted)*, keyed with *KDM for DCI Malformed Test 15b: CPL signed by a certificate not conforming to ST 430-2 (OBAE) (Encrypted)* to the SM. Verify that the SM rejects the CPL. If the SM accepts the CPL, this is cause to fail this test.
14. Attempt to start playback and verify that it is not possible. If playback starts, this is cause to fail this test.
15. Extract a security log from the Test Subject and using a **Text Editor**, identify the `CPLCheck` event associated with the above operation and:
- a. Confirm that all required elements have correctly formatted parameters as defined in [SMPTE-430-5]. Verify that the `contentId` element contains the `Id` of the CPL. Verify that `ReferencedIDs` element contains a `CompositionID` parameter with a value that is the `Id` of the CPL. Missing required elements or incorrect parameters shall be cause to fail this test.
 - b. Confirm the presence of a `CertFormatError` exception in the `CPLCheck` log record. Record any additional parameters associated with the exception. A missing `CertFormatError` exception shall be cause to fail this test.

Supporting Materials

Reference Documents	DCI-DCSS, 9.4.3.5 SMPTE-430-5
Test Materials	<i>DCI Malformed Test 6b: CPL with incorrect track file hashes (OBAE) (Encrypted)</i> <i>KDM for DCI Malformed Test 6b: CPL with incorrect track file hashes (OBAE) (Encrypted)</i> <i>DCI Malformed Test 7b: CPL with an Invalid Signature (OBAE) (Encrypted)</i> <i>KDM for DCI Malformed Test 7b: CPL with an Invalid Signature (OBAE) (Encrypted)</i> <i>DCI Malformed Test 13b: CPL that references a non-existent track file (OBAE) (Encrypted)</i> <i>KDM for DCI Malformed Test 13b: CPL that references a non-existent track file (OBAE) (Encrypted)</i> <i>DCI Malformed Test 14b: CPL that does not conform to ST 429-7 (OBAE) (Encrypted)</i> <i>KDM for DCI Malformed Test 14b: CPL that does not conform to ST 429-7 (OBAE) (Encrypted)</i>

DCI Malformed Test 15b: CPL signed by a certificate not conforming to ST 430-2 (OBAE) (Encrypted)
KDM for DCI Malformed Test 15b: CPL signed by a certificate not conforming to ST 430-2 (OBAE) (Encrypted)

Consolidated Test Sequences

Sequence	Type	Measured Data
20.2. OMB Test Sequence	Pass/Fail	—
21.2. Integrated IMBO Test Sequence	Pass/Fail	—
20.4. OMB Confidence Sequence	Pass/Fail	—
21.4. Integrated IMBO Confidence Sequence	Pass/Fail	—

6.1.23. ContentAuthenticator Element Check (OBAE)

Objective

- Verify that the OBAE-capable Test Subject checks that one of the certificates in the certificate chain supplied with the CPL has a certificate thumbprint that matches the value of the KDM <ContentAuthenticator> element.
- Verify that the OBAE-capable Test Subject checks that such certificate indicates only a "Content Signer (CS) role.

Procedures

For each of the malformations below, load the indicated CPL and KDM on to the Test Subject. Verify that the the KDM is not used to enable playback. A successful playback is cause to fail this test.

1. Use the composition *DCI 2K StEM (OBAE) (Encrypted)* and supply the KDM *KDM with invalid ContentAuthenticator (OBAE)*. The KDM contains a <ContentAuthenticator> element having a certificate thumbprint value that does not match the thumbprint of one of the signer certificates in the certificate chain that signed the associated CPL.
2. Use the composition *DCI Malformed Test 16b: CPL signed with No Role Certificate (OBAE) (Encrypted)* and supply the KDM *KDM for DCI Malformed Test 16b: CPL signed with No Role Certificate (OBAE) (Encrypted)*. The KDM contains a <ContentAuthenticator> element having a certificate thumbprint value that matches the thumbprint of one of the signer certificates in the certificate chain that signed the associated CPL but that certificate has no role.
3. Use the composition *DCI Malformed Test 17b: CPL signed with Bad Role Certificate (OBAE) (Encrypted)* and supply the KDM *KDM for DCI Malformed Test 17b: CPL signed with Bad Role Certificate (OBAE) (Encrypted)*. The KDM contains a <ContentAuthenticator> element having a certificate thumbprint value that matches the thumbprint of one of the signer certificates in the certificate chain that signed the associated CPL but that certificate has a bad role (SM).
4. Use the composition *DCI Malformed Test 18b: CPL signed with Extra Role Certificate (OBAE) (Encrypted)* and supply the KDM *KDM for DCI Malformed Test 18b: KDM for CPL signed with Extra Role Certificate*

(OBAE) (Encrypted). The KDM contains a <ContentAuthenticator> element having a certificate thumbprint value that matches the thumbprint of one of the signer certificates in the certificate chain that signed the associated CPL but that certificate has an extra role.

5. Extract a security log from the Test Subject and using a **Text Editor**, identify the FrameSequencePlayed events associated with the above steps and:

- a. Confirm that all required elements have correctly formatted parameters as defined in [SMPTE-430-5]. Missing required elements or incorrect parameters shall be cause to fail this test.
- b. Confirm the presence of FrameSequencePlayed log records that contain ContentAuthenticatorError exceptions. Record any additional parameters associated with the exception. A missing ContentAuthenticatorError exception in any of the associated FrameSequencePlayed log records shall be cause to fail this test. Only for the operation associated with step 2, a correctly recorded CPLCheck log record with a CertFormatError exception is an allowable substitute for a FrameSequencePlayed log record to satisfy the requirements of this step of the test.

Supporting Materials

Reference Documents	DCI-DCSS, 9.4.3.5 SMPTE-429-7 SMPTE-430-1 SMPTE-430-2 SMPTE-430-5
Test Materials	DCI 2K StEM (OBAE) (Encrypted) KDM with invalid ContentAuthenticator (OBAE) DCI Malformed Test 16b: CPL signed with No Role Certificate (OBAE) (Encrypted) KDM for DCI Malformed Test 16b: CPL signed with No Role Certificate (OBAE) (Encrypted) DCI Malformed Test 17b: CPL signed with Bad Role Certificate (OBAE) (Encrypted) KDM for DCI Malformed Test 17b: CPL signed with Bad Role Certificate (OBAE) (Encrypted) DCI Malformed Test 18b: CPL signed with Extra Role Certificate (OBAE) (Encrypted) KDM for DCI Malformed Test 18b: KDM for CPL signed with Extra Role Certificate (OBAE) (Encrypted)

Consolidated Test Sequences

Sequence	Type	Measured Data
20.2. OMB Test Sequence	Pass/Fail	—
20.4. OMB Confidence Sequence	Pass/Fail	—

6.1.24. KDM Date Check (OBAE)

Objective

Verify that the OBAE-capable Test Subject checks that the playout date is within the time period defined by the KDM `ContentKeysNotValidBefore` and `ContentKeysNotValidAfter` elements.

Procedures

1. Load the composition *DCI 2K StEM (OBAE) (Encrypted)* and KDM *KDM that has expired (OBAE)*, which contains a valid decryption keys, but the KDM has expired.
2. Attempt to play the *DCI 2K StEM (OBAE) (Encrypted)* composition and record the result. Verify that the composition cannot be played. Successful playout is cause to fail this test.
3. Load the composition *DCI 2K StEM (OBAE) (Encrypted)* and the KDM *KDM with future validity period (OBAE)*, which contains a valid decryption keys, but the KDM has is not yet valid.
4. Attempt to play the *DCI 2K StEM (OBAE) (Encrypted)* composition and record the result. Verify that the composition cannot be played. Successful playout is cause to fail this test.
5. Load the composition *DCI 2K StEM (OBAE) (Encrypted)* and KDM *KDM that has recently expired (OBAE)*, which contains a valid decryption keys, but the KDM has expired.
6. Attempt to play the *DCI 2K StEM (OBAE) (Encrypted)* composition and record the result. Verify that the composition cannot be played. Successful playout is cause to fail this test.
7. Load the composition *DCI 2K StEM (OBAE) (Encrypted)* and the KDM *KDM with future validity period (OBAE)*, which contains a valid decryption keys, but the KDM has is not yet valid.
8. Attempt to play the *DCI 2K StEM (OBAE) (Encrypted)* composition and record the result. Verify that the composition cannot be played. Successful playout is cause to fail this test.
9. Extract a security log from the Test Subject and using a **Text Editor**, identify the `FrameSequencePlayed` events associated with the above steps and:
 - a. Confirm that all required elements have correctly formatted parameters as defined in [SMPTE-430-5]. Missing required elements or incorrect parameters shall be cause to fail this test.
 - b. Confirm the presence of a `FrameSequencePlayed` log record that contains a `ValidityWindowError` exception. Record any additional parameters associated with the exception. A missing `ValidityWindowError` exception in any of the associated `FrameSequencePlayed` log records shall be cause to fail this test.

Supporting Materials

Reference Documents	DCI-DCSS, 9.8 SMPTE-430-1 SMPTE-430-5
----------------------------	---

Test Materials	<i>KDM with future validity period (OBAE)</i> <i>KDM that has recently expired (OBAE)</i> <i>KDM that has expired (OBAE)</i> <i>DCI 2K StEM (OBAE) (Encrypted)</i>
-----------------------	---

Consolidated Test Sequences

Sequence	Type	Measured Data
20.2. OMB Test Sequence	Pass/Fail	—

6.2. Link Encryption (LE)

6.2.1. Deleted Section

The section "LDB Trust" was deleted. The section number is maintained here to preserve the numbering of subsequent sections.

6.2.2. Deleted Section

The section "Special Auditorium Situation Operations" was deleted. The section number is maintained here to preserve the numbering of subsequent sections.

6.2.3. Deleted Section

The section "LE Key Usage" was deleted. The section number is maintained here to preserve the numbering of subsequent sections.

6.2.4. Deleted Section

The section "MB Link Encryption" was deleted. The section number is maintained here to preserve the numbering of subsequent sections.

6.3. Clocks and Time

This section describes general requirements concerning the time awareness of the components of the theater system. All procedures are applicable to the Security Manager, with the notable exception of section [6.3.2](#), which is applicable to all SPBs of Type 1.

6.3.1. Clock Adjustment

Objective

- Verify that in order to maintain synchronization between auditoriums, exhibitors are able to adjust a SM's time by a maximum of +/- 6 minutes within any calendar year.
- Verify that the SM time adjustments are logged events.

Procedures

Note:

The following procedures are likely to fail if the Test Subject has had its time adjusted since manufacture. The current time may not be centered on the adjustment range zero point. Any such adjustments, however, will be

evidenced in the security log and by examining the relevant `TimeOffset` elements, the zero point can be derived and the time set accordingly. If necessary, contact the manufacturer for assistance in determining and setting the time to the center of the range of adjustment for the current calendar year.

1. Select for playback the composition *DCI 2K Sync Test (Encrypted)*, keyed with *KDM for DCI 2K Sync Test (Encrypted)*.
2. Play back the composition and at the moment the last frame of picture is reproduced, record the UTC time as provided by an **Accurate Real-Time Clock**.
3. Attempt to advance the time of the SM by 6 minutes. Record whether the adjustment was successful and the UTC time at the moment of adjustment. Failure to successfully adjust the time is cause to fail this test.
4. Repeat Steps 1 and 2.
5. Attempt to advance the time of the SM by 5 seconds. Record whether the adjustment was successful and the UTC time at the moment of adjustment. If the time can be successfully adjusted, this is cause to fail this test.
6. Return the time to the zero point, *i.e.* retard by the total amount successfully advanced in Steps 3 and 5.
7. Attempt to retard the time of the SM by 6 minutes. Record whether the adjustment was successful and the UTC time at the moment of adjustment. Failure to successfully adjust the time is cause to fail this test.
8. Repeat Steps 1 and 2.
9. Attempt to retard the time of the SM by 5 seconds. Record whether the adjustment was successful and the UTC time at the moment of adjustment. If the time can be successfully adjusted, this is cause to fail this test.
10. Extract a security log from the Test Subject that includes the range of time during which the above Steps were carried out.
11. Locate a `FrameSequencePlayed` event caused by Step 2. Subtract the value of the time recorded in Step 2 (UTC time) from the `TimeStamp` from the `LogRecord` (System time). Record this time as the delta of System time to UTC time for the unadjusted state.
12. Locate the `SPBCLockAdjust` event from Step 3 and confirm that the `TimeStamp` contains a value which is the time recorded in Step 3 (UTC time) + the delta from Step 11 + 6 minutes.
13. Locate the `SPBCLockAdjust` event from Step 7 and confirm that the `TimeStamp` contains a value which is the time recorded in Step 7 (UTC time) + the delta from Step 11 - 6 minutes.
14. Locate the `SPBCLockAdjust` event from Step 5 and confirm the presence of an `Exception` with a name of `AdjustmentRangeError`. Confirm that the `TimeStamp` contains a value as follows:
$$T_{\text{log}} = T_{\text{step5}} + T_{\text{step11}} + T_{\text{offset}}$$
where:
 T_{log} is the Timestamp of the log event
 T_{step5} is the time record in Step 5 (UTC time)

$$T_{\text{log}} = T_{\text{step5}} + T_{\text{step11}} + T_{\text{offset}}$$

where:

T_{log} is the Timestamp of the log event

T_{step5} is the time record in Step 5 (UTC time)

T_{step11} is the delta from Step 11

T_{offset} is 6 minutes

The value of the `TimeOffset` parameter shall be ignored.

15. Locate the `SPBCLockAdjust` event from Step 9 and confirm the presence of an Exception with a name of `AdjustmentRangeError`. Confirm that the `TimeStamp` contains a value as follows:

$$T_{\text{log}} = T_{\text{step9}} + T_{\text{step11}} - T_{\text{offset}}$$

where:

T_{log} is the Timestamp of the log event

T_{step9} is the time record in Step 9 (UTC time)

T_{step11} is the delta from Step 11

T_{offset} is 6 minutes

The value of the `TimeOffset` parameter shall be ignored.

16. Locate a `FrameSequencePlayed` event caused by Step 4. Confirm that the `TimeStamp` contains a value which is the time recorded in Step 4 (UTC time) + the delta from Step 11 + 6 minutes.

17. Locate a `FrameSequencePlayed` event caused by Step 8. Confirm that the `TimeStamp` contains a value which is the time recorded in Step 8 (UTC time) + the delta from Step 11 - 6 minutes.

18. Incorrect or missing `LogRecord` elements for Steps 11 through 17 shall be cause to fail this test. *Note: The `TimeStamp` values will have an accuracy that depends on various factors such as system responsiveness, test operator acuity, etc, and are essentially approximate. The intent is to verify that the `TimeStamp` values indeed reflect the time adjustments.*

Supporting Materials

Reference Documents	DCI-DCSS, 9.4.3.7
Test Equipment	Accurate Real-Time Clock
Test Materials	<i>DCI 2K Sync Test (Encrypted)</i> <i>KDM for DCI 2K Sync Test (Encrypted)</i>

Consolidated Test Sequences

Sequence	Type	Measured Data
15.2. Integrated IMB Test Sequence	Pass/Fail	—
15.4. Integrated IMB Confidence Sequence	Pass/Fail	—
20.2. OMB Test Sequence	Pass/Fail	—
21.2. Integrated IMBO Test Sequence	Pass/Fail	—
21.4. Integrated IMBO Confidence Sequence	Pass/Fail	—

6.3.2. SPB Type 1 Clock Battery

Objective

Verify that the Type 1 SPB clock's battery is changeable without losing track of proper time.

Procedures

In the case where the Test Subject must be returned to the manufacturer for battery replacement (*i.e.* field replacement of the battery is not possible), the remainder of this procedure shall be ignored and the reported result of this procedure shall be "N/A".

The phrase "record synchronized accurate time" used below means that the Test Operator records the value of the **Accurate Real-Time Clock** so as to determine a range of predictable deltas between the value of the **Accurate Real-Time Clock** and the timestamp in the log record that corresponds to an event. It is not important that the two times be equal, but that the difference be predictable to within a range that accommodates both variances in the responsiveness of the Test Subject for time stamping the logged operation and the accuracy of the Test Operator. Note: Each end of the range of the deltas is extended by an additional 2 seconds to allow for minor resolution inaccuracies of the testing methodology.

1. Perform the following actions:
 - a. Adjust the clock of the Test Subject +2 seconds, record synchronized accurate time.
 - b. Adjust the clock -2 seconds, record synchronized accurate time.
2. Repeat step 1 four times.
3. Perform the battery replacement procedure per the manufacturer's instructions.
4. Perform the following actions:
 - a. Adjust the clock +2 seconds, record synchronized accurate time.
 - b. Adjust the clock -2 seconds, record synchronized accurate time.
5. Extract a log report for a time period that includes the times during which steps 1-4 were performed.
6. The absence of a log record for any of the clock adjustments made by the above steps shall be cause to fail this test.
7. For each of the five repetitions of step 1a, subtract 2 seconds from the event timestamp to compensate for the 2 seconds added to the SM clock. Compute the delta, in seconds, between the recorded synchronized accurate time and the logged time for the event. Assign the label of $1a_{min}$ to the minimum delta in the set. Assign the label of $1a_{max}$ to the maximum delta in the set.
8. For each of the five repetitions of step 1b, compute the delta, in seconds, between the recorded synchronized accurate time and the logged time for the event. No adjustment to the event timestamps is required as the

clock has been returned to its original setting. Assign the label of $1b_{min}$ to the minimum delta in the set. Assign the label of $1b_{max}$ to the maximum delta in the set.

9. For the event in step 4a, subtract 2 seconds from the event timestamp to compensate for the 2 seconds added to the SM clock. Compute the delta, in seconds, between the recorded synchronized accurate time and the logged time for the event and record the value as $4a$. A value of $4a$ that is less than $1a_{min} - 2$ seconds is cause to fail the test. A value of $4a$ that is greater than $1a_{max} + 2$ seconds is cause to fail the test.
10. For the event in step 4b, compute the delta, in seconds, between the recorded synchronized accurate time and the logged time for the event and record the value as $4b$. A value of $4b$ that is less than $1b_{min} - 2$ seconds is cause to fail the test. A value of $4b$ that is greater than $1b_{max} + 2$ seconds is cause to fail the test.

Supporting Materials

Reference Documents	DCI-DCSS, 9.4.3.7
Test Equipment	Accurate Real-Time Clock

Consolidated Test Sequences

Sequence	Type	Measured Data
15.2. Integrated IMB Test Sequence	Pass/Fail	—
20.2. OMB Test Sequence	Pass/Fail	—
21.2. Integrated IMBO Test Sequence	Pass/Fail	—

6.3.3. Clock Resolution

Objective

Verify that the SM clock has a resolution to one second.

Procedures

1. Setup and play back a show containing the composition *64 Reel Composition, 1 Second Reels (Encrypted)*, keyed with *KDM for 64 1 second reel Composition (Encrypted)*. This composition contains 64 reels of encrypted essence, each with a duration of one (1) second.
2. Examine the log records produced by the above playback. If the time stamps of the log entries are recorded to one (1) second resolution, it can be deduced that the SM clock has a resolution of at least one second. Failure to meet this requirement is cause to fail this test.

Supporting Materials

Reference Documents	DCI-DCSS, 9.4.3.7
Test Materials	<i>64 Reel Composition, 1 Second Reels (Encrypted)</i> <i>KDM for 64 1 second reel Composition (Encrypted)</i>

Consolidated Test Sequences

Sequence	Type	Measured Data
15.2. Integrated IMB Test Sequence	Pass/Fail	—
21.2. Integrated IMBO Test Sequence	Pass/Fail	—

6.3.4. Clock Resolution (OMB)

Objective

Verify that the OMB clock has a resolution to one second.

Procedures

1. Setup and play back a show containing the composition *64 Reel Composition, 1 Second Reels (OBAE) (Encrypted)*, keyed with *KDM for 64 1 second reel Composition (OBAE) (Encrypted)*. This composition contains 64 reels of encrypted essence, each with a duration of one (1) second.
2. Examine the log records produced by the above playback. If the time stamps of the log entries are recorded to one (1) second resolution, it can be deduced that the OMB clock has a resolution of at least one second. Failure to meet this requirement is cause to fail this test.

Supporting Materials

Reference Documents	DCI-DCSS, 9.4.3.7
Test Materials	<i>64 Reel Composition, 1 Second Reels (OBAE) (Encrypted)</i> <i>KDM for 64 1 second reel Composition (OBAE) (Encrypted)</i>

Consolidated Test Sequences

Sequence	Type	Measured Data
20.2. OMB Test Sequence	Pass/Fail	—

6.3.5. Clock Adjustment (OMB)

Objective

- Verify that in order to maintain synchronization between auditoriums, exhibitors are able to adjust an OMB's time by a maximum of +/- 6 minutes within any calendar year.
- Verify that the OMB time adjustments are logged events.

Procedures

Note:
The following procedures are likely to fail if the Test Subject has had its time adjusted since manufacture. The current time may not be centered on the adjustment range zero point. Any such adjustments, however, will be

evidenced in the security log and by examining the relevant `TimeOffset` elements, the zero point can be derived and the time set accordingly. If necessary, contact the manufacturer for assistance in determining and setting the time to the center of the range of adjustment for the current calendar year.

1. Select for playback the composition *DCI 2K Sync Test (OBAE) (Encrypted)*, keyed with *KDM for DCI 2K Sync Test (OBAE) (Encrypted)*.
2. Play back the composition and at the moment the last frame of picture is reproduced, record the UTC time as provided by an **Accurate Real-Time Clock**.
3. Attempt to advance the time of the OMB by 6 minutes. Record whether the adjustment was successful and the UTC time at the moment of adjustment. Failure to successfully adjust the time is cause to fail this test.
4. Repeat Steps 1 and 2.
5. Attempt to advance the time of the OMB by 5 seconds. Record whether the adjustment was successful and the UTC time at the moment of adjustment. If the time can be successfully adjusted, this is cause to fail this test.
6. Return the time to the zero point, *i.e.* retard by the total amount successfully advanced in Steps 3 and 5.
7. Attempt to retard the time of the OMB by 6 minutes. Record whether the adjustment was successful and the UTC time at the moment of adjustment. Failure to successfully adjust the time is cause to fail this test.
8. Repeat Steps 1 and 2.
9. Attempt to retard the time of the OMB by 5 seconds. Record whether the adjustment was successful and the UTC time at the moment of adjustment. If the time can be successfully adjusted, this is cause to fail this test.
10. Extract a security log from the Test Subject that includes the range of time during which the above Steps were carried out.
11. Locate a `FrameSequencePlayed` event caused by Step 2. Subtract the value of the time recorded in Step 2 (UTC time) from the `TimeStamp` from the `LogRecord` (System time). Record this time as the delta of System time to UTC time for the unadjusted state.
12. Locate the `SPBClockAdjust` event from Step 3 and confirm that the `TimeStamp` contains a value which is the time recorded in Step 3 (UTC time) + the delta from Step 11 + 6 minutes.
13. Locate the `SPBClockAdjust` event from Step 7 and confirm that the `TimeStamp` contains a value which is the time recorded in Step 7 (UTC time) + the delta from Step 11 - 6 minutes.
14. Locate the `SPBClockAdjust` event from Step 5 and confirm the presence of an `Exception` with a name of `AdjustmentRangeError`. Confirm that the `TimeStamp` contains a value as follows:
$$T_{\text{log}} = T_{\text{step5}} + T_{\text{step11}} + T_{\text{offset}}$$
where:
 T_{log} is the Timestamp of the log event

$$T_{\text{log}} = T_{\text{step5}} + T_{\text{step11}} + T_{\text{offset}}$$

where:

T_{log} is the Timestamp of the log event

T_{step5} is the time record in Step 5 (UTC time)

T_{step11} is the delta from Step 11

T_{offset} is 6 minutes

The value of the `TimeOffset` parameter shall be ignored.

15. Locate the `SPBCLockAdjust` event from Step 9 and confirm the presence of an Exception with a name of `AdjustmentRangeError`. Confirm that the `TimeStamp` contains a value as follows:

$$T_{\text{log}} = T_{\text{step9}} + T_{\text{step11}} - T_{\text{offset}}$$

where:

T_{log} is the Timestamp of the log event

T_{step9} is the time record in Step 9 (UTC time)

T_{step11} is the delta from Step 11

T_{offset} is 6 minutes

The value of the `TimeOffset` parameter shall be ignored.

16. Locate a `FrameSequencePlayed` event caused by Step 4. Confirm that the `TimeStamp` contains a value which is the time recorded in Step 4 (UTC time) + the delta from Step 11 + 6 minutes.

17. Locate a `FrameSequencePlayed` event caused by Step 8. Confirm that the `TimeStamp` contains a value which is the time recorded in Step 8 (UTC time) + the delta from Step 11 - 6 minutes.

18. Incorrect or missing `LogRecord` elements for Steps 11 through 17 shall be cause to fail this test. *Note: The `TimeStamp` values will have an accuracy that depends on various factors such as system responsiveness, test operator acuity, etc, and are essentially approximate. The intent is to verify that the `TimeStamp` values indeed reflect the time adjustments.*

Supporting Materials

Reference Documents	DCI-DCSS, 9.4.3.7
Test Equipment	Accurate Real-Time Clock
Test Materials	<i>DCI 2K Sync Test (OBAE) (Encrypted)</i> <i>KDM for DCI 2K Sync Test (OBAE) (Encrypted)</i>

Consolidated Test Sequences

Sequence	Type	Measured Data
20.2. OMB Test Sequence	Pass/Fail	—
20.4. OMB Confidence Sequence	Pass/Fail	—

6.4. Forensic Marking (FM)

6.4.1. FM Application Constraints

Objective

- Verify that FM is not applied to non-encrypted audio or image content.
- Verify that FM is not applied to Track Files that are not encrypted in case portions of a composition are encrypted and other portions are not.
- Verify that event log records reflect the FM state.

Procedures

1. Play back the *DCP 2K FM Application Constraints (Encrypted)*, keyed with *KDM for 2K FM Application Constraints (Encrypted)* and present the reproduced image and each of the 16 channels of sound to the appropriate Forensic Marking (FM) detector. With an **Accurate Real-Time Clock**, note the UTC time at the moment playback is started. This package has a CPL that selects between encrypted and plaintext, image and sound track files in a specific order.
2. Verify that the FM detectors report the following status for the presentation: Note: Each segment of the presentation is approximately 35 minutes long and contains slates at the head and tail.
 - a. The first segment of the presentation should indicate both image FM and sound FM are absent.
 - b. The second segment of the presentation should indicate image FM is present and sound FM is absent.
 - c. The third segment of the presentation should indicate image FM is absent and sound FM is present.
 - d. The last segment of the presentation should indicate both image FM and sound FM are present.

Any discrepancy between the expected and reported FM states is cause to fail this test.

3. Extract a security log from the Test Subject that includes the range of time during which step 1 was carried out.
4. Using a **Text Editor**, locate the `FrameSequencePlayed` records that correspond to the encrypted track files played during the presentation segments and:
 - a. Verify there are no `FrameSequencePlayed` records corresponding to the first segment of the presentation (plaintext track files do not generate these records).
 - b. Verify that `FrameSequencePlayed` records corresponding to the second segment of the presentation contain values of the `ImageMark` parameter equal to "true" and do not contain an `AudioMark` parameter.
 - c. Verify that `FrameSequencePlayed` records corresponding to the third segment of the presentation contain values of the `AudioMark` parameter equal to "true" and do not contain an `ImageMark`

parameter.

d. For the FrameSequencePlayed records corresponding to the last segment of the presentation:

- i. Verify that records associated with image track files contain one ImageMark parameter with value "true" and do not contain an AudioMark parameter; and
- ii. verify that records associated with audio track files contain one AudioMark parameter with value "true" and do not contain an ImageMark parameter

Failure of any these verifications is cause to fail this test.

Note: the equipment manufacturer is required to provide a suitable FM decoder (*i.e.*, software and hardware).

Supporting Materials

Reference Documents	DCI-DCSS, 9.4.6.2
Test Equipment	FM Detector Accurate Real-Time Clock
Test Materials	<i>2K FM Application Constraints (Encrypted)</i> <i>KDM for 2K FM Application Constraints (Encrypted)</i>

Consolidated Test Sequences

Sequence	Type	Measured Data
15.2. Integrated IMB Test Sequence	Pass/Fail	—
21.2. Integrated IMBO Test Sequence	Pass/Fail	—

6.4.2. Granularity of FM Control

Objective

- Verify that "No FM mark" states are capable of being independently controlled, for audio and image, via appropriate use of the ForensicMarkFlagList element of the KDM for audio and image Track Files.
- Verify that the ForensicMarkFlagList element of the KDM and thus the "no FM mark" state applies to the entire CPL/composition, according to the associated KDM.
- Verify that the "no FM mark" state does not apply to any other composition, even if the other composition is part of the same showing (*i.e.*, same Show Playlist).
- Verify that event log records reflect the FM state.

Procedures

1. Build a show playlist out of the following four compositions, in the order listed:

1. *2K FM Control Granularity - No FM (Encrypted)*, keyed with *KDM for 2K FM Control Granularity - No FM (Encrypted)*.
 2. *2K FM Control Granularity - Image Only FM (Encrypted)*, keyed with *KDM for 2K FM Control Granularity - Image Only FM (Encrypted)*.
 3. *2K FM Control Granularity - Sound Only FM (Encrypted)*, keyed with *KDM for 2K FM Control Granularity - Sound Only FM (Encrypted)*.
 4. *2K FM Control Granularity - Image and Sound FM (Encrypted)*, keyed with *KDM for 2K FM Control Granularity - Image and Sound FM (Encrypted)*.
2. Play back the show, and present the reproduced image and each of the 16 channels of sound to the appropriate Forensic Marking (FM) detector. With an **Accurate Real-Time Clock**, note the UTC time at the moment playback is started.
3. Verify that the FM detectors report the following status for the presentation:
- a. *2K FM Control Granularity - No FM (Encrypted)*: No image FM and no audio FM for the whole composition.
 - b. *2K FM Control Granularity - Image Only FM (Encrypted)*: Image FM present, but no audio FM, for the whole composition.
 - c. *2K FM Control Granularity - Sound Only FM (Encrypted)*: No image FM, but audio FM present, for the whole composition.
 - d. *2K FM Control Granularity - Image and Sound FM (Encrypted)*: Image FM and audio FM present for the whole composition.

Any discrepancy between the expected and reported FM states is cause to fail this test.

4. Extract a security log from the Test Subject that includes the range of time during which step 2 was carried out.
5. Using a **Text Editor**, locate `FrameSequencePlayed` records corresponding to the playback and:
- a. For the `FrameSequencePlayed` records corresponding to the playback of *2K FM Control Granularity - No FM (Encrypted)*:
 - i. Verify that records associated with image track files contain one `ImageMark` parameter with value "false" and do not contain an `AudioMark` parameter; and
 - ii. verify that records associated with audio track files contain one `AudioMark` parameter with value "false" and do not contain an `ImageMark` parameter.

- b. For the FrameSequencePlayed records corresponding to the playback of *2K FM Control Granularity - Image Only FM (Encrypted)*:
 - i. Verify that records associated with image track files contain one ImageMark parameter with value "true" and do not contain an AudioMark parameter; and
 - ii. verify that records associated with audio track files contain one AudioMark parameter with value "false" and do not contain an ImageMark parameter.
- c. For the FrameSequencePlayed records corresponding to the playback of *2K FM Control Granularity - Sound Only FM (Encrypted)*:
 - i. Verify that records associated with image track files contain one ImageMark parameter with value "false" and do not contain an AudioMark parameter; and
 - ii. verify that records associated with audio track files contain one AudioMark parameter with value "true" and do not contain an ImageMark parameter.
- d. For the FrameSequencePlayed records corresponding to the playback of *2K FM Control Granularity - Image and Sound FM (Encrypted)*:
 - i. Verify that records associated with image track files contain one ImageMark parameter with value "true" and do not contain an AudioMark parameter; and
 - ii. verify that records associated with audio track files contain one AudioMark parameter with value "true" and do not contain an ImageMark parameter.

Failure of any these verifications is cause to fail this test.

Note: the equipment manufacturer is required to provide a suitable FM decoder (*i.e.*, software and hardware).

Supporting Materials

Reference Documents	DCI-DCSS, 9.4.6.2 SMPTE-430-1
Test Equipment	FM Detector Accurate Real-Time Clock
Test Materials	<i>2K FM Control Granularity - No FM (Encrypted)</i> <i>2K FM Control Granularity - Image Only FM (Encrypted)</i> <i>2K FM Control Granularity - Sound Only FM (Encrypted)</i> <i>2K FM Control Granularity - Image and Sound FM (Encrypted)</i> <i>KDM for 2K FM Control Granularity - No FM (Encrypted)</i> <i>KDM for 2K FM Control Granularity - Image Only FM (Encrypted)</i> <i>KDM for 2K FM Control Granularity - Sound Only FM (Encrypted)</i> <i>KDM for 2K FM Control Granularity - Image and Sound FM (Encrypted)</i>

Consolidated Test Sequences

Sequence	Type	Measured Data
15.2. Integrated IMB Test Sequence	Pass/Fail	—
21.2. Integrated IMBO Test Sequence	Pass/Fail	—

6.4.3. FM Payload

Objective

- Verify that the Forensic Marking data payload contains both time stamp and location data.
- Verify that every 15 minutes, 24 hours per day, 366 days/year are time stamped (will repeat annually).
- Verify that the correct number of bits is allocated for the time stamp and location data.
- Verify that the entire Forensic Marking data payload is included in each five minute segment.
- Verify that recovery is possible with a 30-minute content sample for positive identification.

Procedures

1. Determine, from the manufacturer, if the location data allows 524,288 (19 bits) or 1,048,576 (20 bits) distinct values.
2. Setup and play a show using the composition *2K FM Payload (Encrypted)*, keyed with *KDM for KDM for 2K FM Payload (Encrypted)*.
3. Play a section 30 minutes in length and use appropriate image and audio FM detectors to extract the data payload of the Forensic Marking.
4. Verify that the Forensic Marking decoder indicates that a "positive identification" has been made.
5. Verify that the Forensic Marking decoder reports that the following data is contained within both image and each of the 16 audio channels:
 - a. a 16-bit time stamp value.
 - b. a location value whose number of bits matches that determined in Step (1).
6. Verify that two or three sequential time stamps have been recovered during the 30 minute content sample.

Failure to verify any of the above conditions shall be cause to fail this test.

Note:

An assessment of whether any allowed value for the time stamp and location data can be included in each 5

require testing to continue for a full calendar year. Instead a design review verifies that all specified timestamp and location values can be carried in the Forensic Marking.

Supporting Materials

Reference Documents	DCI-DCSS, 9.4.6.1.1
Test Equipment	FM Decoder
Test Materials	<i>2K FM Payload (Encrypted)</i> <i>KDM for 2K FM Payload (Encrypted)</i>

Consolidated Test Sequences

Sequence	Type	Measured Data
15.2. Integrated IMB Test Sequence	Pass/Fail	—
15.4. Integrated IMB Confidence Sequence	Pass/Fail	—
21.2. Integrated IMBO Test Sequence	Pass/Fail	—
21.4. Integrated IMBO Confidence Sequence	Pass/Fail	—
24.2. SDR Projector Test Sequence	Pass/Fail	—
24.4. SDR Projector Confidence Sequence	Pass/Fail	—
26.2. HDR Direct View Display Test Sequence	Pass/Fail	—
26.4. HDR Direct View Display Confidence Sequence	Pass/Fail	—
27.2. SDR Direct View Display Test Sequence	Pass/Fail	—
27.4. SDR Direct View Display Confidence Sequence	Pass/Fail	—
28.2. HDR Projector Test Sequence	Pass/Fail	—
28.4. HDR Projector Confidence Sequence	Pass/Fail	—

6.4.4. FM Audio Bypass

Objective

- Verify that the Media Block does not alter the audio content essence when forensic marking is disabled using the KDM ForensicMarkFlagList "no FM mark" or "selective audio FM mark" commands.

Procedures

1. Load and playback in their entirety the following CPLs using the associated KDM. For each, capture all 16 audio channels output from the Media Block using a **Digital Audio Recorder** in such a way that the captured audio signal is bit-for-bit identical to the output audio signal.
 - a. *Binary Audio Forensic Marking Bypass Test (Encrypted)* and *KDM for Binary Audio Forensic Marking Test (Encrypted)*
 - b. *Binary Audio Forensic Marking Bypass Test (Encrypted)* and *KDM for Binary Selective Audio Forensic Marking Test (Encrypted)*

2. Using **Sound Editor** or equivalent software, verify that, for each audio channel captured in Step 1.a, the sequence of captured audio samples is bit-for-bit identical to a continuous sequence of an equal number of audio samples from the corresponding audio channel from the source sound track file. Any discrepancy is cause to fail this test.

3. Using **Sound Editor** or equivalent software, verify that, for each of audio channels 7-16 captured in Step 1.b, the sequence of captured audio samples is bit-for-bit identical to a continuous sequence of an equal number of audio samples from the corresponding audio channel from the source sound track file. Any discrepancy is cause to fail this test.

Supporting Materials

Reference Documents	DCI-DCSS, 9.4.6.2
Test Equipment	Digital Audio Recorder
Test Materials	<i>Binary Audio Forensic Marking Bypass Test (Encrypted)</i> <i>KDM for Binary Audio Forensic Marking Test (Encrypted)</i> <i>KDM for Binary Selective Audio Forensic Marking Test (Encrypted)</i>

Consolidated Test Sequences

Sequence	Type	Measured Data
15.2. Integrated IMB Test Sequence	Pass/Fail	—
21.2. Integrated IMBO Test Sequence	Pass/Fail	—

6.4.5. Selective Audio FM Control

Objective

- Verify that the forensic marking "selective audio FM mark" and "no FM mark" states can be commanded by the `ForensicMarkFlagList` element of the KDM that enables payout.

- Verify that when commanded, the "no FM mark" state shall apply to the entire encrypted DCP. The "no FM mark" state shall not apply to any other DCP, even if the other DCP is part of the same showing (*i.e.*, same Show Playlist).

- Verify that if both the "no FM mark" and "selective audio FM mark" are present in the KDM used to enable the selective audio FM mark command, the "selective audio FM mark" will override the "no FM mark" command.

- Verify that only one `ForensicMarkFlagList` URI of the form `http://www.dcmovies.com/430-1/2006/KDM#mrkflg-audio-disable-above-channel-XX` (where XX is a value in the set {01, 02, 03, 04, 05, 06, 07, 08, 09, 10, 11, 12, 13, 14, 15, 16 ... 99}) is allowed in the KDM used to enable the selective audio FM mark command.

Procedures

1. Build a show playlist out of the following four compositions, keyed with their KDMs, in the order listed

- o *Selective Audio FM - No FM (Encrypted)*, keyed with KDM for *Selective Audio FM - No FM (Encrypted)*
- o *Selective Audio FM - Not Above Channel 6 (Encrypted)*, keyed with KDM for *Selective Audio FM - Not Above Channel 6 (Encrypted)*
- o *Selective Audio FM - Not Above Channel 8 (Encrypted)*, keyed with KDM for *Selective Audio FM - Not Above Channel 8 (Encrypted)*
- o *Selective Audio FM - All FM (Encrypted)*, keyed with KDM for *Selective Audio FM - All FM (Encrypted)*

Note: The KDM *KDM for Selective Audio FM - Not Above Channel 6 (Encrypted)* contains both a "selective audio FM mark" and a "no FM mark" URI in the `ForensicMarkFlagList`.

2. Play back the show, and present the reproduced sound to the appropriate Forensic Marking (FM) detector. With an **Accurate Real-Time Clock**, note the UTC time at the moment playback is started.
3. Verify that the FM detectors report the following status for the presentation:
 - a. *Selective Audio FM - No FM (Encrypted)*: No audio FM for any of the 16 audio channels, for the whole composition.
 - b. *Selective Audio FM - Not Above Channel 6 (Encrypted)*: Audio FM present on channels 1 through 6 inclusive, and absent on channels 7 through 16 inclusive, for the whole composition.
 - c. *Selective Audio FM - Not Above Channel 8 (Encrypted)*: Audio FM present on channels 1 through 8 inclusive, and absent on channels 9 through 16 inclusive, for the whole composition.
 - d. *Selective Audio FM - All FM (Encrypted)*: Audio FM present, on all 16 channels, for the whole composition.

Any discrepancy between the expected and reported FM states is cause to fail this test.

4. Extract a security log from the Test Subject that includes the range of time during which step 2 was carried out.
5. Using a **Text Editor**, locate `FrameSequencePlayed` records corresponding to the playback and:
 - a. For the `FrameSequencePlayed` records corresponding to the playback of *Selective Audio FM - No FM (Encrypted)*: Verify that records associated with audio track files contain one `AudioMark` parameter with value "false" and do not contain an `ImageMark` parameter.
 - b. For the `FrameSequencePlayed` records corresponding to the playback of *Selective Audio FM - Not Above Channel 6 (Encrypted)*: Verify that records associated with audio track files contain one `AudioMark` parameter with value "true" and do not contain an `ImageMark` parameter.

- c. For the `FrameSequencePlayed` records corresponding to the playback of *Selective Audio FM - Not Above Channel 8 (Encrypted)*: Verify that records associated with audio track files contain one `AudioMark` parameter with value "true" and do not contain an `ImageMark` parameter.
- d. For the `FrameSequencePlayed` records corresponding to the playback of *Selective Audio FM - All FM (Encrypted)*: Verify that records associated with audio track files contain one `AudioMark` parameter with value "true" and do not contain an `ImageMark` parameter.

Failure of any these verifications is cause to fail this test.

6. Build a show playlist out of the following four compositions, keyed with their KDMs, in the order listed

- o *Selective Audio FM - All FM (Encrypted)*, keyed with KDM for *Selective Audio FM - All FM (Encrypted)*
- o *Selective Audio FM - Not Above Channel 10 (Encrypted)*, keyed with KDM for *Selective Audio FM - Not Above Channel 10 (Encrypted)*
- o *Selective Audio FM - Not Above Channel 17 (Encrypted)*, keyed with KDM for *Selective Audio FM - Not Above Channel 17 (Encrypted)*
- o *Selective Audio FM - No FM (Encrypted)*, keyed with KDM for *Selective Audio FM - No FM (Encrypted)*

Note: The KDM *KDM for Selective Audio FM - Not Above Channel 17 (Encrypted)* contains both a "selective audio FM mark" and a "no FM mark" URI in the `ForensicMarkFlagList`.

7. Play back the show, and present the reproduced sound to the appropriate Forensic Marking (FM) detector. With an **Accurate Real-Time Clock**, note the UTC time at the moment playback is started.

8. Verify that the FM detectors report the following status for the presentation:

- a. *Selective Audio FM - All FM (Encrypted)*: Audio FM present, on all 16 channels, for the whole composition.
- b. *Selective Audio FM - Not Above Channel 10 (Encrypted)*: Audio FM present on channels 1 through 10 inclusive, and absent on channels 11 through 16 inclusive, for the whole composition.
- c. *Selective Audio FM - Not Above Channel 17 (Encrypted)*: Audio FM present, on all 16 channels, for the whole composition.
- d. *Selective Audio FM - No FM (Encrypted)*: No audio FM for any of the 16 audio channels, for the whole composition.

Any discrepancy between the expected and reported FM states is cause to fail this test.

9. Extract a security log from the Test Subject that includes the range of time during which step 7 was carried out.

10. Using a **Text Editor**, locate FrameSequencePlayed records corresponding to the playback and:
- a. For the FrameSequencePlayed records corresponding to the playback of *Selective Audio FM - All FM (Encrypted)*: Verify that records associated with audio track files contain one AudioMark parameter with value "true" and do not contain an ImageMark parameter.
 - b. For the FrameSequencePlayed records corresponding to the playback of *Selective Audio FM - Not Above Channel 10 (Encrypted)*: Verify that records associated with audio track files contain one AudioMark parameter with value "true" and do not contain an ImageMark parameter.
 - c. For the FrameSequencePlayed records corresponding to the playback of *Selective Audio FM - Not Above Channel 17 (Encrypted)*: Verify that records associated with audio track files contain one AudioMark parameter with value "true" and do not contain an ImageMark parameter.
 - d. For the FrameSequencePlayed records corresponding to the playback of *Selective Audio FM - No FM (Encrypted)*: Verify that records associated with audio track files contain one AudioMark parameter with value "false" and do not contain an ImageMark parameter.

Failure of any these verifications is cause to fail this test.

11. Set up a show using the composition *DCI 2K StEM (Encrypted)*, keyed with the KDM *KDM with two selective audio FM mark URIs*.
12. Attempt to start playback and record the result. Successful start of playback is cause to fail this test.

Supporting Materials

Reference Documents	DCI-DCSS, 9.4.6.2
Test Equipment	FM Decoder
Test Materials	<i>Selective Audio FM - No FM (Encrypted)</i> <i>Selective Audio FM - All FM (Encrypted)</i> <i>Selective Audio FM - Not Above Channel 6 (Encrypted)</i> <i>Selective Audio FM - Not Above Channel 8 (Encrypted)</i> <i>Selective Audio FM - Not Above Channel 10 (Encrypted)</i> <i>Selective Audio FM - Not Above Channel 17 (Encrypted)</i> <i>DCI 2K StEM (Encrypted)</i> <i>KDM for Selective Audio FM - No FM (Encrypted)</i> <i>KDM for Selective Audio FM - All FM (Encrypted)</i> <i>KDM for Selective Audio FM - Not Above Channel 6 (Encrypted)</i> <i>KDM for Selective Audio FM - Not Above Channel 8 (Encrypted)</i> <i>KDM for Selective Audio FM - Not Above Channel 10 (Encrypted)</i> <i>KDM for Selective Audio FM - Not Above Channel 17 (Encrypted)</i> <i>KDM with two selective audio FM mark URIs</i>

Consolidated Test Sequences

Sequence	Type	Measured Data
15.2. Integrated IMB Test Sequence	Pass/Fail	—
21.2. Integrated IMBO Test Sequence	Pass/Fail	—

6.4.6. FM Application Constraints (OBAE)

Objective

- Verify that FM is not applied to non-encrypted OBAE or image content.
- Verify that FM is not applied to Track Files that are not encrypted in case portions of a composition are encrypted and other portions are not.
- Verify that event log records reflect the FM state.

Procedures

1. Play back the *DCP 2K FM Application Constraints (OBAE) (Encrypted)*, keyed with *KDM for 2K FM Application Constraints (OBAE)* and present the reproduced image and OBAE-rendered audio channels to the appropriate Forensic Marking (FM) detector. With an **Accurate Real-Time Clock**, note the UTC time at the moment playback is started. This package has a CPL that selects between encrypted and plaintext, image and OBAE track files in a specific order.
2. Verify that the FM detectors report the following status for the presentation: Note: Each segment of the presentation is approximately 35 minutes long and contains slates at the head and tail.
 - a. The first segment of the presentation should indicate both image FM and OBAE FM are absent.
 - b. The second segment of the presentation should indicate image FM is present and OBAE FM is absent.
 - c. The third segment of the presentation should indicate image FM is absent and OBAE FM is present.
 - d. The last segment of the presentation should indicate both image FM and OBAE FM are present.

Any discrepancy between the expected and reported FM states is cause to fail this test.

3. Extract a security log from the Test Subject that includes the range of time during which step 1 was carried out.
4. Using a **Text Editor**, locate the `FrameSequencePlayed` records that correspond to the encrypted track files played during the presentation segments and:
 - a. Verify there are no `FrameSequencePlayed` records corresponding to the first segment of the presentation (plaintext track files do not generate these records).

- b. Verify that `FrameSequencePlayed` records corresponding to the second segment of the presentation contain values of the `ImageMark` parameter equal to `"true"` and do not contain an `OBAEMark` parameter.
- c. Verify that `FrameSequencePlayed` records corresponding to the third segment of the presentation contain values of the `OBAEMark` parameter equal to `"true"` and do not contain an `ImageMark` parameter.
- d. For the `FrameSequencePlayed` records corresponding to the last segment of the presentation:
 - i. Verify that records associated with image track files contain one `ImageMark` parameter with value `"true"` and do not contain an `OBAEMark` parameter; and
 - ii. verify that records associated with OBAE track files contain one `OBAEMark` parameter with value `"true"` and do not contain an `ImageMark` parameter

Failure of any these verifications is cause to fail this test.

Note: the equipment manufacturer is required to provide a suitable FM decoder (*i.e.*, software and hardware).

Supporting Materials

Reference Documents	DCI-DCSS, 9.4.6.2, 9.4.6.3.8
Test Equipment	FM Detector Accurate Real-Time Clock
Test Materials	<i>2K FM Application Constraints (OBAE) (Encrypted)</i> <i>KDM for 2K FM Application Constraints (OBAE)</i>

Consolidated Test Sequences

Sequence	Type	Measured Data
20.2. OMB Test Sequence	Pass/Fail	—
21.2. Integrated IMBO Test Sequence	Pass/Fail	—

6.4.7. Granularity of FM Control (OBAE)

Objective

- Verify that the `ForensicMarkFlagList` element of the KDM:
 - controls the application of forensic marking independently for OBAE and image essence kinds;
 - applies to the entire composition; and
 - applies exclusively to the Composition targeted by the KDM and no other composition, even if the other composition is part of the same show (*i.e.*, same Show Playlist).

- Verify that event log records reflect the application of the `ForensicMarkFlagList` element of the KDM.

Procedures

1. Build a show playlist out of the following four compositions, in the order listed:
 1. *2K FM Control Granularity - No FM (OBAE) (Encrypted)*, keyed with KDM for *2K FM Control Granularity - No FM (OBAE)*.
 2. *2K FM Control Granularity - Image Only FM (OBAE) (Encrypted)*, keyed with KDM for *2K FM Control Granularity - Image Only FM (OBAE)*.
 3. *2K FM Control Granularity - OBAE Only FM (OBAE) (Encrypted)*, keyed with KDM for *2K FM Control Granularity - OBAE Only FM (OBAE)*.
 4. *2K FM Control Granularity - Image and OBAE FM (OBAE) (Encrypted)*, keyed with KDM for *2K FM Control Granularity - Image and OBAE FM (OBAE)*.
2. Play back the show, and present the reproduced image and all OBAE-rendered audio channels to the appropriate Forensic Marking (FM) detector. With an **Accurate Real-Time Clock**, note the UTC time at the moment playback is started.
3. Verify that the FM detectors report the following status for the presentation:
 - a. *2K FM Control Granularity - No FM (OBAE) (Encrypted)*: No image FM and no OBAE FM for the whole composition.
 - b. *2K FM Control Granularity - Image Only FM (OBAE) (Encrypted)*: Image FM present, but no OBAE FM, for the whole composition.
 - c. *2K FM Control Granularity - OBAE Only FM (OBAE) (Encrypted)*: No image FM, but OBAE FM present, for the whole composition.
 - d. *2K FM Control Granularity - Image and OBAE FM (OBAE) (Encrypted)*: Image FM and OBAE FM present for the whole composition.

Any discrepancy between the expected and reported FM states is cause to fail this test.
4. Extract a security log from the Test Subject that includes the range of time during which step 2 was carried out.
5. Using a **Text Editor**, locate `FrameSequencePlayed` records corresponding to the playback and:
 - a. For the `FrameSequencePlayed` records corresponding to the playback of *2K FM Control Granularity - No FM (OBAE) (Encrypted)*:

- i. Verify that records associated with image track files contain one ImageMark parameter with value "false" and do not contain an OBAEMark parameter; and
 - ii. verify that records associated with OBAE track files contain one OBAEMark parameter with value "false" and do not contain an ImageMark parameter.
 - b. For the FrameSequencePlayed records corresponding to the playback of *2K FM Control Granularity - Image Only FM (OBAE) (Encrypted)*:
 - i. Verify that records associated with image track files contain one ImageMark parameter with value "true" and do not contain an OBAEMark parameter; and
 - ii. verify that records associated with OBAE track files contain one OBAEMark parameter with value "false" and do not contain an ImageMark parameter.
 - c. For the FrameSequencePlayed records corresponding to the playback of *2K FM Control Granularity - OBAE Only FM (OBAE) (Encrypted)*:
 - i. Verify that records associated with image track files contain one ImageMark parameter with value "false" and do not contain an OBAEMark parameter; and
 - ii. verify that records associated with OBAE track files contain one OBAEMark parameter with value "true" and do not contain an ImageMark parameter.
 - d. For the FrameSequencePlayed records corresponding to the playback of *2K FM Control Granularity - Image and OBAE FM (OBAE) (Encrypted)*:
 - i. Verify that records associated with image track files contain one ImageMark parameter with value "true" and do not contain an OBAEMark parameter; and
 - ii. verify that records associated with OBAE track files contain one OBAEMark parameter with value "true" and do not contain an ImageMark parameter.

Failure of any these verifications is cause to fail this test.

Note: the equipment manufacturer is required to provide a suitable FM decoder (*i.e.*, software and hardware).

Supporting Materials

Reference Documents	DCI-DCSS, 9.4.6.2, 9.4.6.3.8 SMPTE-430-1
Test Equipment	FM Detector Accurate Real-Time Clock
Test Materials	<i>2K FM Control Granularity - No FM (OBAE) (Encrypted)</i> <i>2K FM Control Granularity - Image Only FM (OBAE) (Encrypted)</i> <i>2K FM Control Granularity - OBAE Only FM (OBAE) (Encrypted)</i>

2K FM Control Granularity - Image and OBAE FM (OBAE) (Encrypted)
KDM for 2K FM Control Granularity - No FM (OBAE)
KDM for 2K FM Control Granularity - Image Only FM (OBAE)
KDM for 2K FM Control Granularity - OBAE Only FM (OBAE)
KDM for 2K FM Control Granularity - Image and OBAE FM (OBAE)

Consolidated Test Sequences

Sequence	Type	Measured Data
20.2. OMB Test Sequence	Pass/Fail	—
21.2. Integrated IMBO Test Sequence	Pass/Fail	—

6.4.8. FM Payload (OBAE)

Objective

- Verify that the Forensic Marking data payload for OBAE essence contains both time stamp and location data.
- Verify that every 15 minutes, 24 hours per day, 366 days/year are time stamped (will repeat annually).
- Verify that the correct number of bits is allocated for the time stamp and location data.
- Verify that the entire Forensic Marking data payload is included in each five minute segment.
- Verify that recovery is possible with a 30-minute content sample for positive identification.
- Verify that recovery is possible with a range of OBAE rendering configurations.

Procedures

Perform the following steps:

1. Determine, from the manufacturer, if the location data allows 524,288 (19 bits) or 1,048,576 (20 bits) distinct values.
2. Setup a show using the composition *2K FM Payload (OBAE) (Encrypted)*, keyed with *KDM for 2K FM Payload (OBAE) (Encrypted)*.
3. Setup the Test Subject with the maximum number of rendered channels supported by the system.
4. Perform the following steps:
 - A. Play a section 30 minutes in length and use appropriate OBAE FM detectors to extract the data payload of the Forensic Marking.
 - B. Verify that the Forensic Marking decoder indicates that a "positive identification" has been made.

C. Verify that the Forensic Marking decoder reports that the following data is contained within each of the rendered audio channels:

a. a 16-bit time stamp value.

b. a location value whose number of bits matches that determined in Step (1).

D. Verify that two or three sequential time stamps have been recovered during the 30 minute content sample.

Failure to verify any of the above conditions shall be cause to fail this test.

Note:

An assessment of whether any allowed value for the time stamp and location data can be included in each 5 minute segments is impractical. For example, verifying that all specified timestamp values are allowed would require testing to continue for a full calendar year. Instead a design review verifies that all specified timestamp and location values can be carried in the Forensic Marking.

Supporting Materials

Reference Documents	DCI-DCSS, 9.4.6.1.1
Test Equipment	FM Decoder
Test Materials	<i>2K FM Payload (OBAE) (Encrypted)</i> <i>KDM for 2K FM Payload (OBAE) (Encrypted)</i>

Consolidated Test Sequences

Sequence	Type	Measured Data
20.2. OMB Test Sequence	Pass/Fail	—
21.2. Integrated IMBO Test Sequence	Pass/Fail	—
20.4. OMB Confidence Sequence	Pass/Fail	—
21.4. Integrated IMBO Confidence Sequence	Pass/Fail	—

6.4.9. FM Audio Bypass (OBAE)

Objective

Verify that the Media Block does not alter the OBAE content essence when forensic marking is disabled using the KDM ForensicMarkFlagList "no FM mark" commands.

Procedures

1. Setup the Test Subject with the maximum number of rendered channels supported by the system.
2. Load and playback in their entirety the following CPLs using the associated KDM. For each, capture all rendered channels output from the Media Block using a **Digital Audio Recorder** in such a way that the

captured audio signal is bit-for-bit identical to the output audio signal.

- a. *2K FM Payload (OBAE) (Encrypted)* and *KDM for 2K FM Payload (OBAE) with FM Bypass (Encrypted)*, where forensic marking application to the OBAE essence is disabled using the "no FM mark" flag; and
- b. *2K FM Payload (plaintext OBAE) (Encrypted)* and *KDM for 2K FM Payload (plaintext OBAE) (Encrypted)*, where forensic marking is not applied to the OBAE essence since it is plaintext.

3. Using **Sound Editor** or equivalent software, verify that, for each audio channel captured in Step 2, the sequence of captured audio samples is bit-for-bit identical between Steps 2.a and 2.b. Any discrepancy is cause to fail this test.

Supporting Materials

Reference Documents	DCI-DCSS, 9.4.6.2
Test Equipment	Digital Audio Recorder Sound Editor
Test Materials	<i>2K FM Payload (OBAE) (Encrypted)</i> <i>KDM for 2K FM Payload (OBAE) with FM Bypass (Encrypted)</i> <i>2K FM Payload (plaintext OBAE) (Encrypted)</i> <i>KDM for 2K FM Payload (plaintext OBAE) (Encrypted)</i>

Consolidated Test Sequences

Sequence	Type	Measured Data
20.2. OMB Test Sequence	Pass/Fail	—
21.2. Integrated IMBO Test Sequence	Pass/Fail	—

6.5. Image Reproduction

6.5.1. Playback of Image Only Material

Objective

Verify that the theatre system is capable of playing back content that consists of image only, *i.e.*, has no corresponding audio or other track.

Procedures

Play back the DCP *DCI NIST Frame no sound files*. This package comprises image only. Verify that the image is displayed correctly. Failure to display the image is cause to fail this test.

Supporting Materials

Reference Documents	DCI-DCSS, 5.3.1.3
Test Materials	<i>DCI NIST Frame no sound files</i>

Consolidated Test Sequences

Sequence	Type	Measured Data
15.2. Integrated IMB Test Sequence	Pass/Fail	—
20.2. OMB Test Sequence	Pass/Fail	—
21.2. Integrated IMBO Test Sequence	Pass/Fail	—

6.5.2. Decoder Requirements

Objective

- Verify that the image decoder meets all requirements for JPEG 2000 image decoder presented in [DCI-DCSS], Section 4.3.2
- Verify that the decoder decodes each color component at 12 bits per sample, with equal color/component bandwidth, and does not subsample chroma (*i.e.*, does not generate any 4:2:2 signal or similar), except as permitted by [DCI-DCSS], Section 2.1.1.4
- For 2K decoders, verify that it shall decode 2K data for every frame in a 4K distribution.
- For 4K decoders, verify that it shall decode 4K data for every frame in a 4K distribution.

Procedures

1. Verify that the decoder output conforms to the following image specifications:

- a. 2K = 2048 x 1080 at 24 fps
- b. 2K = 2048 x 1080 at 48 fps
- c. 4K = 4096 x 2160 at 24 fps

To verify this, build and play a single show containing the compositions *DCI 2K Sync Test (2K@24fps)*, *DCI 2K Sync Test (48fps) (2K@48fps)* and *4K Sync Test (4K@24fps)*. Verify that playback is successful and that image and audio are properly reproduced as described below.

The test images used in the referenced compositions are similar for each of the 2K and 4K variants. In many cases, the features as they appear in the 2K image are simply scaled to create the 4K image. The description of the features of the 2k variant follows. Note that failure language declared in the 2k variant description will be modified later in this procedure to describe compliant display of the image on 24 fps 4K and 48 fps 2K displays.

In the image descriptions that follow, the term "source pixel" is used to define the respective image feature in terms of the input signal. The Imaging Device may have a different resolution than the image, in which case a given input -- the source pixel -- may be mapped to some number of display pixels other than one, and may also contribute to shading on adjacent pixels. For example, a line that is one source pixel in width in the 2K image should appear two pixels in width on a 4K display. Similarly, a line that is one source pixel in width in the 4K image will likely appear diminished -- perhaps significantly -- on a 2K display, and will perhaps not be centered on a particular line of the Imaging Device's pixels.

i. For the *DCI 2K Sync Test* composition (2K@24fps), locate and confirm the appearance of the following features of the test image:

- A. A yellow reticle defines the area of the 1:1.85 aspect ratio (1998 x 1080). The lines comprising the reticle are one source pixel in width. Small, outward facing arrows of matching color indicate the reticle position for the case where some occlusion prevents display of the horizontal lines (*i.e.*, the top-most or bottommost lines of the image.) Failure to display the full reticle shall be cause to fail the test.
- B. A green reticle defines the area of the 1:2.39 aspect ratio (2048 x 858). The lines comprising the reticle are one source pixel in width. Small, outward facing arrows of matching color indicate the reticle position for the case where some occlusion prevents display of the vertical lines (*i.e.*, the left-most or right-most lines of the image.) Failure to display the full reticle shall be cause to fail the test.
- C. A non-antialiased circle is placed in the center of the image. The source pixels comprising the circle are either ref-white or background-gray. The circle should appear to have equal height and width. Distortion of the circle geometry shall be cause to fail the test.
- D. To the left of the circle are six patches, in two rows of three. From left to right, top to bottom, the patches are designated P1, P2, P3, P4, P5, P6. (See [Figure 6.1](#) below for a graphical definition of the panel designations.)
 - a. Pattern P1 is a pair of grayscale concentric squares having two different luminances. The outer square is dark gray (12-bit X'Y'Z' code values 122,128,125). The inner square is absolute black (12-bit X'Y'Z' code values 0,0,0).
 - b. Pattern P2 is a set of sixty (60) horizontal lines, each line being one source pixel in height, alternating red-green-blue, from top to bottom. Failure to display the correct colors and number of lines shall be cause to fail the test.
 - c. Pattern P3 is a set of thirty (30) horizontal lines, each line being two source pixels in height, alternating red-green-blue, from top to bottom. Failure to display the correct colors and number of lines shall be cause to fail the test.
 - d. Pattern P4 is a 60 x 60 "checkerboard" array of black and white areas. The size of each black or white area is one source pixel. Failure to display the pattern with uniform color, contrast and area size shall be cause to fail the test.
 - e. Pattern P5 is a set of sixty (60) vertical lines, each line being one source pixel in width, alternating red-green-blue, from left to right. Failure to display the correct colors and number of lines shall be cause to fail the test.
 - f. Pattern P6 is a set of thirty (30) vertical lines, each line being two source pixels in width, alternating red-green-blue, from left to right. Failure to display the correct colors and number of lines shall be cause to fail the test.

E. To the right of the circle are six patches, in two rows of three. From left to right, top to bottom, the patches are designated P7, P8, P9, P10, P11, P12.

- a. Pattern P7 is a set of thirty (30) horizontal lines, each line being two source pixels in height, alternating black-white, from top to bottom. Failure to display the correct colors and number of lines shall be cause to fail the test.
- b. Pattern P8 is a set of sixty (60) horizontal lines, each line being one source pixel in height, alternating black-white, from top to bottom. Failure to display the correct colors and number of lines shall be cause to fail the test.
- c. Pattern P9 is a pair of grayscale concentric squares having two different luminances. The outer square is reference white (12-bit X'Y'Z' code values (3794, 3960, 3890)). The inner square is absolute white (12-bit X'Y'Z' code values (4095,4095,4095)). Note that the square having absolute white color will have red hue.
- d. Pattern P10 is a set of thirty (30) vertical lines, each line being two source pixels in width, alternating black-white, from left to right. Failure to display the correct colors and number of lines shall be cause to fail the test.
- e. Pattern P11 is a set of sixty (60) vertical lines, each line being one source pixel in width, alternating black-white, from left to right. Failure to display the correct colors and number of lines shall be cause to fail the test.
- f. Pattern P12 is a 30 x 30 "checkerboard" array of black and white areas. The size of each black or white area is two source pixels square. Failure to display the pattern with uniform color and area size shall be cause to fail the test.

F. Below the circle is a set of twenty (20) rectangular grayscale patches, in two centered horizontal rows of ten (10) patches each. Each patch has a distinct luminance, which are defined in [SMPTE-431-2]. No two adjacent patches should appear to have the same luminance. Failure to display twenty distinct patches shall be cause to fail the test.

ii. For the *4K Sync Test* composition (4K@24fps), locate and confirm the appearance of the features of the test image as described for the *DCI 2K Sync Test* composition, with the following exceptions:

- A. Pattern P2 is a set of one hundred twenty (120) horizontal lines, each line being one source pixel in height, alternating red-green-blue, From top to bottom. When displayed on a 2K display, no pass/fail criteria shall be applied. Failure to display the correct colors and number of lines shall be cause to fail the test.
- B. Pattern P3 is a set of sixty (60) horizontal lines, each line being two source pixels in height, alternating red-green-blue, From top to bottom. When displayed on a 2K display, this feature will appear as pattern P2 in the 2K test frame. Failure to display the correct colors and number of lines shall be cause to fail the test.

- C. Pattern P4 is a 120 x 120 "checkerboard" array of black and white areas. The size of each black or white area is one source pixel. When displayed on a 2K display, this feature will appear as a uniform (but perhaps variegated) gray field. Failure to display the pattern with uniform color, contrast and area size shall be cause to fail the test.

 - D. Pattern P5 is a set of one hundred twenty (120) vertical lines, each line being one source pixel in width, alternating red-green-blue, From left to right. When displayed on a 2K display, no pass/fail criteria shall be applied. Failure to display the correct colors and number of lines shall be cause to fail the test.

 - E. Pattern P6 is a set of sixty (60) vertical lines, each line being two source pixels in width, alternating redgreen- blue, from left to right. When displayed on a 2K display, this feature will appear as pattern P5 in the 2K test frame. Failure to display the correct colors and number of lines shall be cause to fail the test.

 - F. Pattern P7 is a set of sixty (60) horizontal lines, each line being two source pixels in height, alternating black-white, from top to bottom. When displayed on a 2K display, this feature will appear as pattern P8 in the 2K test frame. Failure to display the correct colors and number of lines shall be cause to fail the test.

 - G. Pattern P8 is a set of one hundred twenty (120) horizontal lines, each line being one source pixel in height, alternating black-white, from top to bottom. When displayed on a 2K display, no pass/fail criteria shall be applied. Failure to display the correct colors and number of lines shall be cause to fail the test.

 - H. Pattern P10 is a set of sixty (60) vertical lines, each line being two source pixels in width, alternating black- white, from left to right. When displayed on a 2K display, this feature will appear as pattern P11 in the 2K test frame. Failure to display the correct colors and number of lines shall be cause to fail the test.

 - I. Pattern P11 is a set of one hundred twenty (120) vertical lines, each line being one source pixel in width, alternating black-white, from left to right. When displayed on a 2K display, no pass/fail criteria shall be applied. Failure to display the correct colors and number of lines shall be cause to fail the test.

 - J. Pattern P12 is a 60 x 60 "checkerboard" array of black and white areas. The size of each black or white area is two source pixels square. Failure to display the pattern with uniform color and area size shall be cause to fail the test.
- iii. For the *DCI 2K Sync Test (48fps)* composition (2K@48fps), locate and confirm the appearance of the features of the test image as described for the *DCI 2K Sync Test* composition, with the following exceptions:
- A. In the case where the MB provides image data to the projector via dual 1.5 Gb/s (or single 3 Gb/s) SDI link, [DCI-DCSS], Section 2.1.1.4 allows chroma subsampling on 48 fps images (*i.e.* 4:2:2). In this case, patch P5 of the 2K test image is expected to be displayed with chroma blending. Patch P3 may display chroma blending, depending on the coincidence of the 2X

horizontal source pixels and the subsampling algorithm. Patch P6 is expected to be reproduced discretely, with no visible chroma blending. No blending shall be visible for any of the patches P7, P8, P10 and P11. The number of lines displayed in patterns P7 and P10 shall be thirty (30). The number of lines displayed in patterns P8 and P11 shall be sixty (60). Failure to display the correct number of lines in each of the panels P7, P8, P10 and P11 shall be cause to fail the test. Appearance of chroma blending deviating from the above shall be cause to fail the test.

2. Verify that the decoder outputs 12-bit X'Y'Z' color:
 - a. To test for 12 bit color reproduction play back the composition *DCI 2K Moving Gradient*. This clip contains a special moving pattern to reveal usage of all 12 bits. The pattern contains three vertical bands, each 250 horizontal pixels in width, corresponding to 12, 11 and 10 bit representations of a sine wave that advances in value by 1 degree per pixel. The bands are labeled with the 12 bit region on the left, 11 bit region in the center and 10 bit region on the right of the screen. Examine the image for artifacts such as contouring or vertical striations. Any such noticeable artifacts in the 12 bit region of the pattern is cause to fail this test. The 11 and 10 bit regions are provided for reference.
3. To test for X'Y'Z' color reproduction: Using a **DCI Projector**, properly calibrated for Luminance and Color Calibration and a **Spectroradiometer**, perform the following steps:
 - a. For each of the 12 Color Accuracy color patch code values referenced in [SMPTE-431-2], Table A.4, display the given X'Y'Z' code values. This may be achieved by displaying a suitable test file or by delivering the appropriate signal to an external interface (e.g. Dual-Link HD-SDI). Measure and record the displayed Luminance and Color Coordinates for each of the Color Accuracy patches.
 - b. Play back the composition *Color Accuracy Series* and measure and record the displayed Luminance and Color Coordinates for each of the Color Accuracy patches.
 - c. For each of the the corresponding reference and decoded values recorded in steps i and ii, calculate the x and y delta values and record them.

If any of the values recorded in step iii exceed the tolerances defined in [SMPTE-431-2], Table A, Section 7.9 this is cause to fail this test.

4. For 4K decoders, verify that it shall decode 4K data for every frame in a 4K distribution, or for 2K decoders, verify that it shall decode 2K data for every frame in a 4K distribution. To test this perform the following procedure:
 - a. Play back the composition *2K DCI Maximum Bitrate Composition (Encrypted)*, keyed with *KDM for 2K Maximum Bitrate Composition (Encrypted)*. This composition contains a codestream at the maximum allowable bitrate of an image with a burned in counter, incremented by one with every frame. The projected image must be filmed with a suitable camera and then be viewed in slow motion to verify that no counter numbers are skipped. Failure to observe all the numbered frames shall be cause to fail this test. Verify that the projected image contains a clearly visible, regular pattern that does not change over time (except for the burned in counter). If any other artifacts are noted (e.g. flickering or similar) this is cause to fail this test.

- b. Play back the composition *4K DCI Maximum Bitrate Composition (Encrypted)*, keyed with *KDM for 4K Maximum Bitrate Composition (Encrypted)*. This composition contains a codestream at the maximum allowable bitrate of an image with a burned in counter, incremented by one with every frame. The projected image must be filmed with a suitable camera and then be viewed in slow motion to verify that no counter numbers are skipped. Failure to observe all the numbered frames shall be cause to fail this test. Verify that the projected image contains a clearly visible, regular pattern that does not change over time (except for the burned in counter). If any other artifacts are noted (e.g. flickering or similar) this is cause to fail this test.

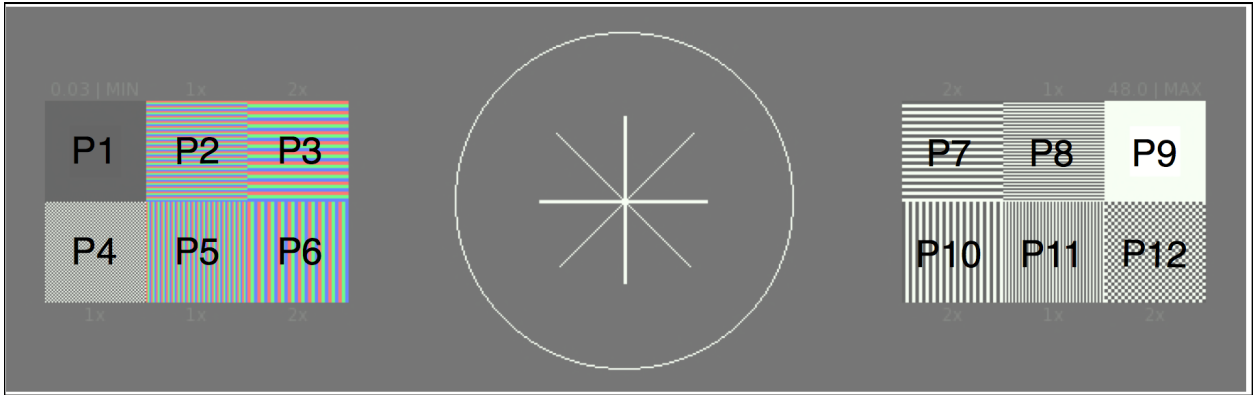

Figure 6.1. Standard Frame Panel Designations

Supporting Materials

Reference Documents	DCI-DCSS, 4.3.2, 2.1.1.4 SMPTE-428-1 SMPTE-430-2
Test Equipment	48 fps Camera
Test Materials	<i>DCI 2K Sync Test</i> <i>DCI 2K Sync Test (48fps)</i> <i>4K Sync Test</i> <i>DCI 2K Moving Gradient</i> <i>Color Accuracy Series</i> <i>2K DCI Maximum Bitrate Composition (Encrypted)</i> <i>4K DCI Maximum Bitrate Composition (Encrypted)</i> <i>KDM for 2K Maximum Bitrate Composition (Encrypted)</i> <i>KDM for 4K Maximum Bitrate Composition (Encrypted)</i>

Consolidated Test Sequences

Sequence	Type	Measured Data
15.2. Integrated IMB Test Sequence	Pass/Fail	—
21.2. Integrated IMBO Test Sequence	Pass/Fail	—

6.6. Audio Reproduction

6.6.1. Digital Audio Interfaces

Objective

Verify that the Media Block has a digital audio output interface with the capacity for delivering 16 channels of digital audio at 24-bit 48 kHz or (optionally) 96 kHz, and follows the [AES3-2003] recommended practice for serial transmission format for two-channel linearly represented digital audio data.

Procedures

1. Play the composition *DCI 1-16 Numbered Channel Identification* which contains spoken identification for each of the 16 audio channels and verify correct output. Failure to confirm correct reproduction on any channel is cause to fail this test.

2. Play the composition *DCI NIST Frame with Pink Noise* which contains 16 channels of Pink Noise at 48kHz sample rate and verify:
 - a. 48kHz AES3 signal at all outputs.

 - b. Pink noise bandwidth to 22kHz.

 - c. 24 active bits on analyzer.
Failure to confirm above conditions a, b and c, is cause to fail this test.

3. If the Test Subject supports playback of 96 kHz audio, play the composition *DCI NIST Frame with Pink Noise (96 kHz)* which contains 16 channels of Pink Noise at 96kHz sample rate and verify:
 - a. 96kHz AES3 signal at all outputs.

 - b. Pink noise bandwidth to 44kHz.

 - c. 24 active bits on analyzer.
Failure to confirm above conditions a, b and c, is cause to fail this test.

Supporting Materials

Reference Documents	AES3-2003 DCI-DCSS, 7.5.4.3, 7.5.6.1, 7.5.6.2
Test Equipment	AES3 Audio Analyzer
Test Materials	<i>DCI 1-16 Numbered Channel Identification</i> <i>DCI NIST Frame with Pink Noise</i> <i>DCI NIST Frame with Pink Noise (96 kHz)</i>

Consolidated Test Sequences

15.2. Integrated IMB Test Sequence	Pass/Fail	—
21.2. Integrated IMBO Test Sequence	Pass/Fail	—

6.6.2. Audio Sample Rate Conversion

Objective

If it supports playback of 96 kHz audio, verify that the Test Subject has the capability of performing Sample Rate Conversion (SRC) when needed.

Procedures

Only applies to a Test Subject that supports playback of 96 kHz audio.

1. Play back the DCP DCI NIST Frame with 1 kHz tone (-20 dB fs, 96kHz). Enable SRC on the system, select an output rate of 48kHz. With an AES analyzer, confirm that each of the AES-3 outputs are producing an AES signal with a 48kHz sample rate. Any other measured output sample rate is cause to fail this test.
2. Play back the DCP DCI NIST Frame with 1 kHz tone (-20 dB fs). Enable SRC on the system, select an output rate of 96kHz. With an AES analyzer, confirm that each of the AES-3 outputs are producing an AES signal with a 96kHz sample rate. Any other measured output sample rate is cause to fail this test.

Supporting Materials

Reference Documents	DCI-DCSS, 3.3.2.1
Test Equipment	AES3 Audio Analyzer
Test Materials	DCI NIST Frame with 1 kHz tone (-20 dB fs) DCI NIST Frame with 1 kHz tone (-20 dB fs, 96kHz)

Consolidated Test Sequences

Sequence	Type	Measured Data
15.2. Integrated IMB Test Sequence	Pass/Fail	—
21.2. Integrated IMBO Test Sequence	Pass/Fail	—

6.6.3. Audio Delay Setup

Objective

Verify that the system provides a method for adjusting the delay of the audio signal relative to the image. It must be possible to offset audio +/-200 ms in 10 ms increments.

Procedures

1. Connect channel 1 of the oscilloscope to the analog center channel output of the sound equipment.
2. Connect channel 2 of the oscilloscope to a photodiode that is placed in front of the screen of the Imaging Device, where the flashing rectangle is located.

3. Perform the following steps:

- a. Play back the composition *DCI 2K Sync Test*. This composition contains short beeps (one frame in length) and a white flashing rectangle at the bottom of the screen, synchronized to the beeps.
- b. Measure the delay between the light pulse and the audio pulse. This will depend on a combination of many factors such as the image processing delay of the imaging device, sound processing delay in the sound equipment, and digital signal transmission delays (buffering of data). Record the timing with zero offset applied to the unit under test. Use this nominal figure as the reference point for the following steps.
- c. Set the offset to -200 ms and verify that the delay observed at the oscilloscope corresponds is consistent with the nominal figure minus 200 ms. Failure to meet this requirement is cause to fail this test.
- d. Set the offset to +200 ms and verify that the delay observed at the oscilloscope corresponds is consistent with the nominal figure plus 200 ms. Failure to meet this requirement is cause to fail this test.
- e. Set the offset to -190 ms and verify that the delay observed at the oscilloscope corresponds is consistent with the nominal figure minus 190 ms. Failure to meet this requirement is cause to fail this test.
- f. Set the offset to +190 ms and verify that the delay observed at the oscilloscope corresponds is consistent with the nominal figure plus 190 ms. Failure to meet this requirement is cause to fail this test.
- g. Set the offset to -10 ms and verify that the delay observed at the oscilloscope corresponds is consistent with the nominal figure minus 10 ms. Failure to meet this requirement is cause to fail this test.
- h. Set the offset to +10 ms and verify that the delay observed at the oscilloscope corresponds is consistent with the nominal figure plus 10 ms. Failure to meet this requirement is cause to fail this test.

4. Repeat the above test, but this time for 48 fps (use the composition *DCI 2K Sync Test (48fps)*). Record the results obtained.

The image below shows what a typical measurement is expected to look like. The upper trace shows the light output of the Imaging Device, measured by means of the photo diode. The photo diode signal is shown inverted, *i.e.*, low means high light output. The lower trace shows the analog center channel output of the Media Block after D/A conversion from the AES-EBU signal.

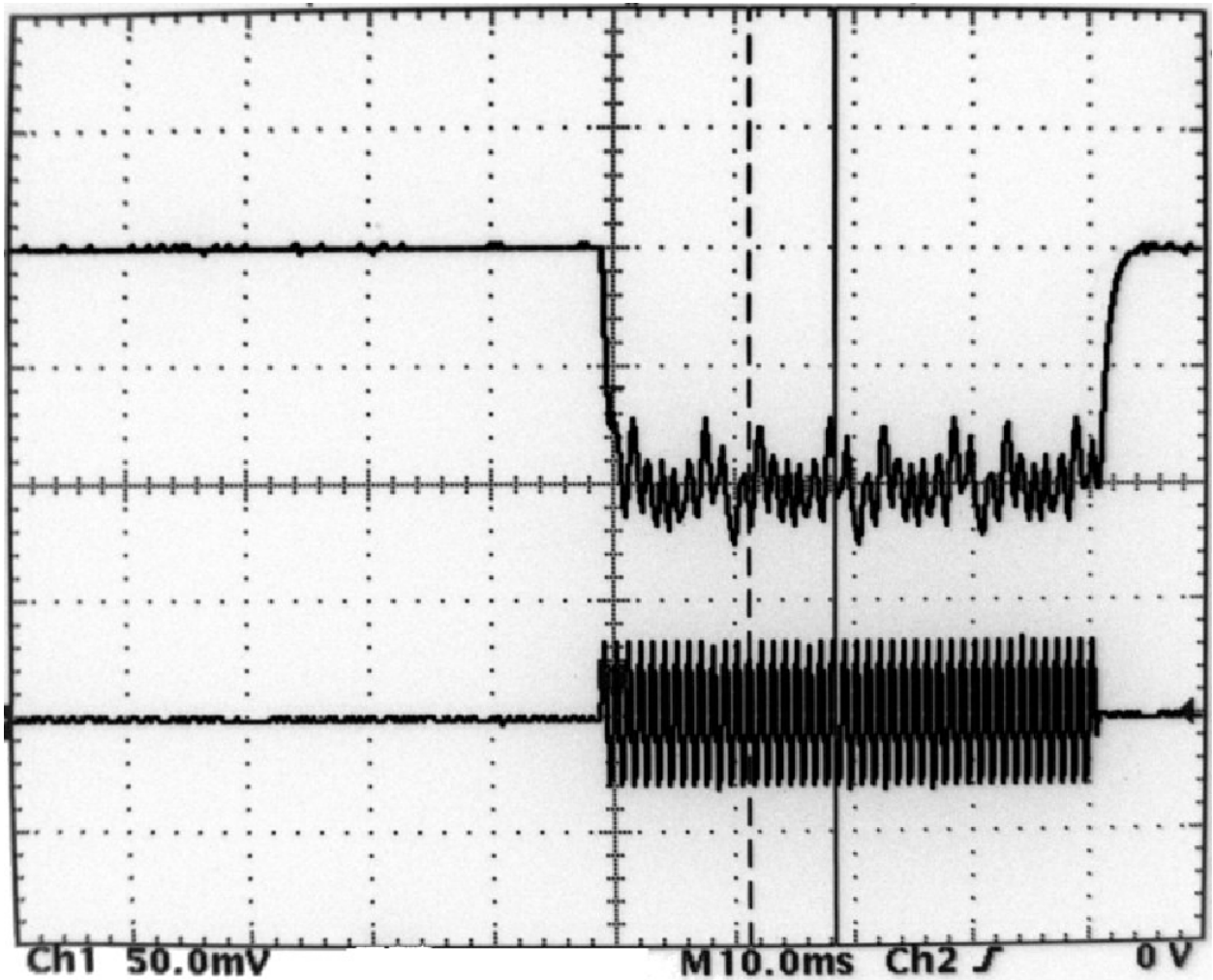

Figure 6.2. Audio Delay Timing

Warning: the optical flashes generated during this test can cause physiological reactions in some people. People who are sensitive to such optical stimuli should not view the test material.

Supporting Materials

Reference Documents	DCI-DCSS, 7.4.1.8
Test Equipment	Oscilloscope Photodiode
Test Materials	<i>DCI 2K Sync Test</i> <i>DCI 2K Sync Test (48fps)</i>

Consolidated Test Sequences

Sequence	Type	Measured Data
15.2. Integrated IMB Test Sequence	Pass/Fail	—
21.2. Integrated IMBO Test Sequence	Pass/Fail	—

6.6.4. Click Free Splicing of Audio Track Files

Objective

Verify that the playback system allows click free splicing of the audio track files.

Note:

Note: Playback of this test must be done in a properly equipped and set up movie theater, at reference level, *i.e.*, fader setting 7.0 for Dolby and compatibles or fader setting 0 dB for Sony and compatibles. A single channel of pink noise at -20dBFS should produce a Sound Pressure Level (SPL) of 85dBc, from any of the front loudspeakers, at the monitoring position. Monitoring by means of smaller monitor boxes or headphones is not sufficient.

Procedures

Play back *DCP for Audio Tone Multi-Reel (Encrypted)*, which contains a sequence of audio track files arranged such that no discontinuity exists at the splice points.

Any audible snap, crackle, pop or other unpleasant artifact at any splice point shall be cause to fail this test.

Supporting Materials

Reference Documents	DCI-DCSS, 5.3.1.6
Test Equipment	Sound System
Test Materials	<i>DCP for Audio Tone Multi-Reel (Encrypted)</i>

Consolidated Test Sequences

Sequence	Type	Measured Data
15.2. Integrated IMB Test Sequence	Pass/Fail	—
21.2. Integrated IMBO Test Sequence	Pass/Fail	—

6.7. Timed Text Reproduction

6.7.1. Media Block Overlay

Objective

Verify that the Test Subject renders Timed Text essence correctly.

Procedures

1. Using an Imaging Device that does not provide an internal subtitle rendering capability (or one in which subtitle rendering capability is disabled), load and play back each of the compositions:
 - a. *2K Scope Subtitle Test (Encrypted)*, keyed with *KDM for 2K Scope Subtitle Test (Encrypted)*.
 - b. *2K Flat Subtitle Test (Encrypted)*, keyed with *KDM for 2K Flat Subtitle Test (Encrypted)*.

- c. *2K Full Subtitle Test (Encrypted)*, keyed with *KDM for 2K Full Subtitle Test (Encrypted)*.
- d. *4K Scope Subtitle Test (Encrypted)*, keyed with *KDM for 4K Scope Subtitle Test (Encrypted)*.
- e. *4K Flat Subtitle Test (Encrypted)*, keyed with *KDM for 4K Flat Subtitle Test (Encrypted)*.
- f. *4K Full Subtitle Test (Encrypted)*, keyed with *KDM for 4K Full Subtitle Test (Encrypted)*.
- g. *2K 48fps Scope Subtitle Test (Encrypted)*, keyed with *KDM for 2K 48fps Scope Subtitle Test (Encrypted)*.
- h. *2K 48fps Flat Subtitle Test (Encrypted)*, keyed with *KDM for 2K 48fps Flat Subtitle Test (Encrypted)*.
- i. *2K 48fps Full Subtitle Test (Encrypted)*, keyed with *KDM for 2K 48fps Full Subtitle Test (Encrypted)*.

2. Refer to Appendix I. Subtitle Test Evaluation and Pass/Fail Criteria and for each scene in each composition, record the state of compliance with the basic and specific pass/fail criteria listed therein. Failure of any compliance criterion is cause to fail this test.

Supporting Materials

Reference Documents	DCI-DCSS, 7.5.4.2.5, 7.5.4.2.6, 7.5.4.2.7 SMPTE-429-2
Test Materials	<i>2K Scope Subtitle Test (Encrypted)</i> <i>2K Flat Subtitle Test (Encrypted)</i> <i>2K Full Subtitle Test (Encrypted)</i> <i>4K Scope Subtitle Test (Encrypted)</i> <i>4K Flat Subtitle Test (Encrypted)</i> <i>4K Full Subtitle Test (Encrypted)</i> <i>2K 48fps Scope Subtitle Test (Encrypted)</i> <i>2K 48fps Flat Subtitle Test (Encrypted)</i> <i>2K 48fps Full Subtitle Test (Encrypted)</i> <i>KDM for 2K Scope Subtitle Test (Encrypted)</i> <i>KDM for 2K Flat Subtitle Test (Encrypted)</i> <i>KDM for 2K Full Subtitle Test (Encrypted)</i> <i>KDM for 4K Scope Subtitle Test (Encrypted)</i> <i>KDM for 4K Flat Subtitle Test (Encrypted)</i> <i>KDM for 4K Full Subtitle Test (Encrypted)</i> <i>KDM for 2K 48fps Scope Subtitle Test (Encrypted)</i> <i>KDM for 2K 48fps Flat Subtitle Test (Encrypted)</i> <i>KDM for 2K 48fps Full Subtitle Test (Encrypted)</i>

Consolidated Test Sequences

Sequence	Type	Measured Data
15.2. Integrated IMB Test Sequence	Pass/Fail	—

21.2. Integrated IMBO Test Sequence	Pass/Fail	—
-------------------------------------	-----------	---

6.7.2. Deleted Section

The section "Timed Text Synchronization" was deleted. The section number is maintained here to preserve the numbering of subsequent sections

6.7.3. Deleted Section

The section "Support for Multiple Captions" was deleted. The section number is maintained here to preserve the numbering of subsequent sections.

6.7.4. Default Timed Text Font

Objective

Only applies to a Test Subject that implements an alpha channel overlay module, a subpicture renderer (a module that converts the subpicture file into a baseband image file with an alpha channel) and a Timed Text renderer (a module that converts Timed Text data into a baseband image file with an alpha channel).

Verify that the Test Subject provides a default font to be used in the case where no font files are supplied with the DCP.

Procedures

1. Load and play the composition *DCI Malformed Test 8: DCP with timed text and a missing font*.
2. Verify that the timed text instances contain multiple lines of text.
3. Failure to correctly display multiple lines of text shall be cause to fail this test.

Supporting Materials

Reference Documents	DCI-DCSS, 3.4.3 SMPTE-428-7 SMPTE-429-5
Test Materials	<i>DCI Malformed Test 8: DCP with timed text and a missing font</i>

Consolidated Test Sequences

Sequence	Type	Measured Data
15.2. Integrated IMB Test Sequence	Pass/Fail	—
21.2. Integrated IMBO Test Sequence	Pass/Fail	—
24.2. SDR Projector Test Sequence	Pass/Fail	—

6.7.5. Deleted Section

The section "Support for Subpicture Display" was deleted. The section number is maintained here to preserve the numbering of subsequent sections.

6.7.6. Timed Text Decryption

Objective

Verify that an SM can play a composition that contains encrypted timed text essence.

Procedures

1. Load the composition *DCI 2K Sync test with Subtitles (Encrypted)* and KDM *KDM for DCI 2K Sync Test with Subtitles (Encrypted)*.
2. Play the composition *DCI 2K Sync test with Subtitles (Encrypted)*.
3. Verify that the timed text appears on screen as indicated by the main picture.
4. Failure to correctly display multiple lines of text shall be cause to fail the test.

Supporting Materials

Reference Documents	DCI-DCSS, 9.7.2, 9.4.3.6.3, 9.4.3.5 SMPTE-428-7 SMPTE-429-5
Test Materials	<i>DCI 2K Sync test with Subtitles (Encrypted)</i> <i>KDM for DCI 2K Sync Test with Subtitles (Encrypted)</i>

Consolidated Test Sequences

Sequence	Type	Measured Data
15.2. Integrated IMB Test Sequence	Pass/Fail	—
21.2. Integrated IMBO Test Sequence	Pass/Fail	—

6.8. OBAE Reproduction

6.8.1. Click Free Splicing of OBAE Track Files

Objective

Verify that the playback system allows click free splicing of OBAE track files.

Note:

Playback of this test must be done in a theatrical environment calibrated and setup for OBAE reproduction. Monitoring by means of smaller monitor boxes or headphones is not sufficient.

Procedures

1. Setup the **OBAE Sound System** with the maximum number of rendered channels supported by the system.
2. Play back *DCP for OBAE Tone Multi-Reel (Encrypted)*, which contains a sequence of OBAE Track Files arranged such that no discontinuity exists at the splice points.

Any audible snap, crackle, pop or other unpleasant artifact at any splice point shall be cause to fail this test.

Supporting Materials

Reference Documents	DCI-DCSS, 5.3.1.6
Test Equipment	OBAE Sound System
Test Materials	<i>DCP for OBAE Tone Multi-Reel (Encrypted)</i>

Consolidated Test Sequences

Sequence	Type	Measured Data
20.2. OMB Test Sequence	Pass/Fail	—
21.2. Integrated IMBO Test Sequence	Pass/Fail	—

6.8.2. OBAE Delay Setup

Objective

Verify that the system provides a method for adjusting the delay of rendered OBAE essence relative to the image. It must be possible to offset audio +/-200 ms in 10 ms increments.

Procedures

1. Connect channel 1 of the oscilloscope to the analog center channel output of the sound equipment.
2. Connect channel 2 of the oscilloscope to a photodiode that is placed in front of the screen of the Imaging Device, where the flashing rectangle is located.
3. Perform the following steps:
 - a. Play back the composition *DCI 2K Sync Test (OBAE)*. This composition contains short beeps (one frame in length) and a white flashing rectangle at the bottom of the screen, synchronized to the beeps.
 - b. Measure the delay between the light pulse and the audio pulse. This will depend on a combination of many factors such as the image processing delay of the imaging device, sound processing delay in the sound equipment, and digital signal transmission delays (buffering of data). Record the timing with zero offset applied to the unit under test. Use this nominal figure as the reference point for the following steps.
 - c. Set the offset to -200 ms and verify that the delay observed at the oscilloscope corresponds is consistent with the nominal figure minus 200 ms. Failure to meet this requirement is cause to fail this test.
 - d. Set the offset to +200 ms and verify that the delay observed at the oscilloscope corresponds is consistent with the nominal figure plus 200 ms. Failure to meet this requirement is cause to fail this test.

- e. Set the offset to -190 ms and verify that the delay observed at the oscilloscope corresponds is consistent with the nominal figure minus 190 ms. Failure to meet this requirement is cause to fail this test.
 - f. Set the offset to +190 ms and verify that the delay observed at the oscilloscope corresponds is consistent with the nominal figure plus 190 ms. Failure to meet this requirement is cause to fail this test.
 - g. Set the offset to -10 ms and verify that the delay observed at the oscilloscope corresponds is consistent with the nominal figure minus 10 ms. Failure to meet this requirement is cause to fail this test.
 - h. Set the offset to +10 ms and verify that the delay observed at the oscilloscope corresponds is consistent with the nominal figure plus 10 ms. Failure to meet this requirement is cause to fail this test.
4. Repeat the above test, but this time for 48 fps (use the composition *DCI 2K Sync Test (48fps)*). Record the results obtained.

Figure 6.2 shows what a typical measurement is expected to look like. The upper trace shows the light output of the Imaging Device, measured by means of the photo diode. The photo diode signal is shown inverted, *i.e.*, low means high light output. The lower trace shows the analog center channel output.

Note:
 The optical flashes generated during this test can cause physiological reactions in some people. People who are sensitive to such optical stimuli should not view the test material.

Supporting Materials

Reference Documents	DCI-DCSS, 7.4.1.8
Test Equipment	Oscilloscope Photodiode
Test Materials	<i>DCI 2K Sync Test (OBAE)</i> <i>DCI 2K Sync Test (48fps) (OBAE)</i>

Consolidated Test Sequences

Sequence	Type	Measured Data
20.2. OMB Test Sequence	Pass/Fail	—
21.2. Integrated IMBO Test Sequence	Pass/Fail	—

6.8.3. Maximum Bitrate OBAE

Objective

Verify that the playback system supports playback of OBAE content that consists of maximum size frames, as defined in [SMPTE-429-18].

Procedures

Perform the following steps:

1. Select and play *Maximum Bitrate OBAE (Encrypted)* keyed with *KDM for Maximum Bitrate OBAE (Encrypted)*.
2. Select and play *Maximum Bitrate OBAE 48 fps (Encrypted)* keyed with *KDM for Maximum Bitrate OBAE 48 fps (Encrypted)*.

Any audible artifact, interruption in playback or inability to start playback is cause to fail this test.

Supporting Materials

Reference Documents	DCI-DCSS, 3.3.4.3, 5.3.4.5 [SMPTE-429-18]
Test Equipment	OBAE Sound System
Test Materials	<i>Maximum Bitrate OBAE (Encrypted)</i> <i>KDM for Maximum Bitrate OBAE (Encrypted)</i> <i>Maximum Bitrate OBAE 48 fps (Encrypted)</i> <i>KDM for Maximum Bitrate OBAE 48 fps (Encrypted)</i>

Consolidated Test Sequences

Sequence	Type	Measured Data
20.2. OMB Test Sequence	Pass/Fail	—
21.2. Integrated IMBO Test Sequence	Pass/Fail	—

6.8.4. OBAE Rendering Expectations

Objective

Verify that the **OBAE Sound System** meets acoustic rendering expectations.

Procedures

Perform the following steps:

1. Configure the **OBAE Sound System** according to J.2. Configuration.
2. Playback *OBAE Rendering Expectations* in its entirety, subject to the requirements specified at J.3. Requirements. Deviation from any of these requirements is cause to fail this test.

Supporting Materials

Reference Documents	DCI-DCSS, 7.5.6.1 [SMPTE-2098-3]
Test Equipment	

OBAE Sound System		
<table border="0" style="width: 100%;"> <tr> <td style="width: 30%;">Test Materials</td> <td><i>OBAE Rendering Expectations</i></td> </tr> </table>	Test Materials	<i>OBAE Rendering Expectations</i>
Test Materials	<i>OBAE Rendering Expectations</i>	

Consolidated Test Sequences

Sequence	Type	Measured Data
20.2. OMB Test Sequence	Pass/Fail	—
21.2. Integrated IMBO Test Sequence	Pass/Fail	—

Chapter 7. Imaging Device

7.1. Test Environment for Image Measurements

7.1.1 General

When making image measurements on any Imaging Device:

- All required setup and calibration procedures, as recommended by the manufacturer, shall be carried out or verified prior to all measurements.
- Stray light on the screen shall be minimized. The room lights in test environment shall be turned off, with the exception of the minimal lighting provided for working or safety reasons. The use of black nonreflective surfaces with recessed lighting is encouraged.

Note that, outside of the Test Environment, e.g. in exhibition theaters or review rooms, safety regulations and the placement of exit lights or access lights can result in a higher ambient light level.

- Unless otherwise specified or required:
 - the distance between the front of the **Spectroradiometer** lens and the screen shall be equal to 1.6 times the height of the screen; and
 - the position of the **Spectroradiometer** shall be equidistant from the left and right edges of the screen.
 - the position of the **Spectroradiometer** shall be equidistant from the top and bottom edges of the screen.

In all cases the location of the **Spectroradiometer** shall be appropriate for the **Spectroradiometer** that is used and for the test being conducted.

7.1.2 Projector

With the Projector turned off or the douser closed, the level of ambient light reflected by the screen shall be:

- less than 0.01 cd/m² for an SDR Projector; and
- less than 0.0005 cd/m² for an HDR Projector.

The screen shall be non-specular and equally reflective over the entire visible spectrum. The screen should have variable black masking, adjustable to tightly frame the projected image (at a minimum, this should include the 1.85:1 and 2.39:1 image formats).

When making image measurements on a Projector:

- The Projector shall be turned on (including the lamp) and allowed to thermally stabilize for 20 to 30 minutes prior to all measurements.
- Unless specified otherwise, the douser shall be open from beginning to end of each test procedure.

7.5.13. Projector Test Environment records information about the test environment in which projector test procedures were conducted.

7.1.3 Direct View Display

With the Direct View Display turned off, the level of ambient light reflected by the screen shall be less than 0.0005 cd/m².

The Direct View Display shall be turned on and allowed to thermally stabilize for 20 to 30 minutes prior to all measurements.

7.5.30. Direct View Display Test Environment records information about the test environment in which the test procedures were conducted.

7.1.4 Stereoscopic Measurements

When performing stereoscopic measurements:

- The Imaging Device shall be enabled for stereoscopic presentations.
- The stereoscopic glasses shall be enabled, if they are active glasses.

7.2. SPB Type 2

7.2.1. Projector and Direct View Display Physical Protection

Objective

- Verify that the projector's or direct view display's companion SPB (MB) and its plaintext image interfaces are physically inside of, or otherwise mechanically connected to, the type 2 SPB.
- Verify that SPB type 2 protection requirements are provided by the Projector or Direct View SPB.

Procedures

- If the Test Subject is a Projector:
 1. By physical examination and using documentation provided by the manufacturer, determine the physical perimeter that provides the type 2 SPB protection for the Projector. Verify that the type 2 SPB provides a hard, opaque physical security perimeter that surrounds the electronics and prevents access to internal circuitry.
Failure of this verification is cause to fail this test.
- If the Test Subject is a Projector or a Direct View Display:

By physical examination and using documentation provided by the manufacturer:

 2. Locate, and for each of any removable access covers and/or doors of the type 2 SPB intended for Security Servicing (*i.e.*, openings that enable access to Security-Sensitive Signals), record whether

they are protected by either (1) mechanical locks employing physical or logical keys and tamper-evident seals (e.g., evidence tape or holographic seals), or (2) pick resistant locks employing physical or logical keys.

The absence of protection as required on any of these security access covers or doors is cause to fail this test.

3. Locate the companion SPB's and type 2 SPB's Security Sensitive Signals. Verify that:
 - a. Security Sensitive Signals are not accessible via (i) any removable access covers and/or doors other than those located in step 2, (ii) any ventilation holes or other openings; and
 - b. Access to Security Sensitive Signals and circuits would cause permanent and easily visible damage. Failure of either of these verifications is cause to fail this test.
4. Locate the Companion SPB (MB). Verify that the Companion SPB is entirely enclosed within, or mechanically connected to, the SPB type 2 enclosure.
Failure to meet this requirement is cause to fail this test.

- If the Test Subject is a Direct View Display:

5. By physical examination and using documentation provided by the manufacturer, verify that:
 - a. The physical intrusion barrier presented by the light emitting front surface of the Direct View Display's Cabinets or Modules is not penetrate-able without permanently destroying the proper operation of a Cabinet and/or Module penetrated, and leaving permanent and easily visible damage.
 - b. Cabinets and/or Modules are mechanically interlocked to each other directly and/or via the supporting frame structure such that any separation that would enable access to internal signals causes permanent and easily visible damage.
 - c. Access to light emitting (pixel generating) component electrical signals from the surface of the screen is limited to individual component pins, and there is no access to signals that would constitute a portion of the picture image beyond the pixel by pixel level.

Failure to meet any of these requirements is cause to fail this test.

Supporting Materials

Reference Documents	DCI-DCSS, 9.4.2.2, 9.4.3.6.1, 9.5.2.2, 9.5.2.4, 9.5.2.4.1
----------------------------	---

Consolidated Test Sequences

Sequence	Type	Measured Data
24.2. SDR Projector Test Sequence	Pass/Fail	—
26.2. HDR Direct View Display Test Sequence	Pass/Fail	—

28.2. HDR Projector Test Sequence	Pass/Fail	—
-----------------------------------	-----------	---

7.2.2. Projector and Direct View Display Security Servicing

Objective

- Verify that the projector or direct view display SPB implements a "security access opening" event signal to the companion SPB.
- Verify that playback terminates and/or is not permitted if the security access opening event is active, or a front removable module has been removed.

Procedures

- If the Test Subject is a Projector or Direct View Display:
By physical examination and using documentation provided by the manufacturer, locate each of the type 2 SPB access door and/or panel openings intended for Security Servicing (*i.e.*, openings that enable access to Security- Sensitive Signals). Execute the following tests 1-4 for each opening found, and record the results.
 1. Play back the DCP *DCI 2K StEM*.
 2. Open the SPB access door/panel and observe that playback terminates. If playback does not terminate, this is cause to fail this test.
 3. Attempt to start playback with the door/panel open. If playback starts, this is cause to fail this test.
 4. Close the opening and examine the logs from the SPB's companion SPB and verify that an "SPBOpen" event was created for each time a door/panel was opened, and an "SPBClose" event was created for each closure. If any log record is missing, this is cause to fail this test.
- If the Test Subject is a Direct View Display:
With the exception of step 6(c), the following tests may be verified by physical examination of the direct view display's type 2 SPB and using documentation provided by the manufacturer:
 5. Noting the servicing method exception defined for step 6 below: Identify and document each distinct method that can be used for replacing (disassembly and reassembly, etc.) a Cabinet or Module. For each method that exposes Security-Sensitive Signals, verify that:
 - a. a security access opening event is triggered, and
 - b. playback is prevented while the security access opening event is active.
Failure of either of the above requirements is cause to fail this test. (It is allowed for one security access opening event to be triggered in the course of simultaneously replacing multiple Cabinets and/or Modules as part of a single servicing event.)
 6. For Cabinets having *front removable Modules* designed for non-security servicing (*i.e.*, designed for Module replacement without triggering a security access opening event), verify that the removal of any front-serviceable Module:

a. exposes only those pixel signals accessible via the electrical connection(s) associated with the Module removed and does not otherwise expose Security-Sensitive Signals or compromise the SPB type 2 perimeter. Note that signaling multiplexing may have a multiplier effect that exposes signals associated with other Modules via the connection(s); this is allowed, but must be considered in step (c) below. Display Security Servicing Failure to meet this requirement is cause to fail this test.

b. is detected and prevents playback of an encrypted composition. Failure to meet this requirement is cause to fail this test.

c. Quantity over 15 (*i.e.*, removal of more than 15 modules), or a quantity that exposes pixel signals constituting more than 5% of the screen area, whichever is less within any 8 hour period, shall trigger a security access opening event.

To execute this step:

i. calculate the minimum number of Modules required to expose pixel signals constituting more than 5% of the screen area, considering the multiplier effect noted in (a). If the number is less than 16, record this number as MaxNumber, otherwise set MaxNumber to 16.

ii. determine a Module removal selection sequence for removing a quantity of (MaxNumber + 1) of Modules which are most likely to stress the Imaging Device's opening detection design.

iii. Recording a test start time as "T0", begin removing and replacing Modules in the sequence order determined in step (ii) until an access opening event has been triggered, or 16 Modules have been removed and replaced. Record this quantity.

iv. Following the manufacturers requirements, clear (reset) the access opening event. After 7 hours and 55 minutes from T0 of step (iii), remove and replace the next Module in sequence. Verify that a security access opening event has been triggered.

A quantity recorded in step (iii) of not less than MaxNumber is cause to fail this test. Failure of a security access opening event to trigger for step (iv) is cause to fail this test.

7. For each occurrence of a security access opening event of tests 4, 5 and 6, verify that:

a. clearing (resetting) of the alarm event requires the use of a physical key or entry of a code,

b. SPBOpen and SPBClose events are logged for each occurrence.

Failure of either of the above requirements is cause to fail this test.

Supporting Materials

Reference Documents	DCI-DCSS, 9.4.3.6.1, 9.5.2.4, 9.5.2.4.1
---------------------	---

Consolidated Test Sequences

Sequence	Type	Measured Data
24.2. SDR Projector Test Sequence	Pass/Fail	—
24.4. SDR Projector Confidence Sequence	Pass/Fail	—
26.2. HDR Direct View Display Test Sequence	Pass/Fail	—
26.4. HDR Direct View Display Confidence Sequence	Pass/Fail	—
27.2. SDR Direct View Display Test Sequence	Pass/Fail	—
27.4. SDR Direct View Display Confidence Sequence	Pass/Fail	—
28.2. HDR Projector Test Sequence	Pass/Fail	—
28.4. HDR Projector Confidence Sequence	Pass/Fail	—

7.2.3. Deleted Section

The section "SPB2 Requirements" was deleted. The section number is maintained here to preserve the numbering of subsequent sections

7.2.4. Deleted Section

The section "SPB2 Secure Silicon Requirements" was deleted. The section number is maintained here to preserve the numbering of subsequent sections.

7.2.5. Deleted Section

The section "SPB2 Tamper Evidence" was deleted. The section number is maintained here to preserve the numbering of subsequent sections.

7.2.6. SPB2 Secure Silicon Field Replacement

Objective

Verify that the secure silicon device, contained within a SPB Type 2, is not field serviceable (though it may be field replaceable). Verify that it is not accessible during normal SPB Type 2 operation or non-security-related servicing.

Procedures

By careful optical and physical examination, verify that the secure silicon device contained within a SPB Type 2

1. is not field serviceable (but may be field replaceable), *i.e.*, there are no provisions for direct access to the SPB Type 2 secure silicon circuitry.
2. is not accessible during normal SPB Type 2 operation or non-security-related servicing, *i.e.*, is mounted in a special compartment separated from areas accessible during operations or normal servicing. If the SPB2 secure silicon device is accessible during non-security servicing or normal operations, this shall be cause to fail this test.

Supporting Materials

Reference Documents	DCI-DCSS, 9.5.2.3
---------------------	-------------------

Consolidated Test Sequences

Sequence	Type	Measured Data
24.2. SDR Projector Test Sequence	Pass/Fail	—
26.2. HDR Direct View Display Test Sequence	Pass/Fail	—
27.2. SDR Direct View Display Test Sequence	Pass/Fail	—
28.2. HDR Projector Test Sequence	Pass/Fail	—

7.2.7. Systems without Electronic Marriage

Objective

Verify that in the configuration of a permanently married companion SPB (MB), the companion SPB is not field replaceable and requires the Imaging Device SPB and companion SPB system to both be replaced in the event of an SPB failure.

Procedures

Verify that the companion SPB Type 1 is not field- replaceable. Careful optical and physical inspection is necessary for this. Any deviation from these requirements is cause to fail this test.

Supporting Materials

Reference Documents	DCI-DCSS, 9.4.3.6.6
---------------------	---------------------

Consolidated Test Sequences

Sequence	Type	Measured Data
24.2. SDR Projector Test Sequence	Pass/Fail	—
26.2. HDR Direct View Display Test Sequence	Pass/Fail	—
27.2. SDR Direct View Display Test Sequence	Pass/Fail	—
28.2. HDR Projector Test Sequence	Pass/Fail	—

7.2.8. Electronic Marriage Break Key Retaining

Objective

Verify that breaking the marriage between the Imaging Device and its companion SPB (MB) does not zeroize the Imaging Device SPB type 2 long term identity keys (RSA private keys).

Procedures

(Only applies to systems that implement an Electronic Marriage, *i.e.*, those that have field replaceable MBs.)

1. Using procedures and tools provided by the manufacturer of the Imaging Device, obtain the device certificate representing the identity of the SPB type 2 in PEM encoded format.

2. Using the procedure illustrated in [Section 2.1.11](#), record the public key thumbprint of the certificate obtained in the above step.
3. Intentionally break the marriage and remarry the systems (this may require support by the manufacturer).
4. Using the same procedure as described in steps 1 and 2, verify that the public key in the certificate supplied by the Imaging Device is the same as before the remarriage. Mismatching public key thumbprints are cause to fail this test.

Supporting Materials

Reference Documents	DCI-DCSS, 9.4.3.6.1
----------------------------	---------------------

Consolidated Test Sequences

Sequence	Type	Measured Data
24.2. SDR Projector Test Sequence	Pass/Fail	—
26.2. HDR Direct View Display Test Sequence	Pass/Fail	—
27.2. SDR Direct View Display Test Sequence	Pass/Fail	—
28.2. HDR Projector Test Sequence	Pass/Fail	—

7.3. Companion SPB Type 1

7.3.1. Deleted Section

The section "Projector Companion SPB Location" was deleted. The section number is maintained here to preserve the numbering of subsequent sections

7.3.2. Companion SPBs with Electronic Marriage

Objective

This test only applies to field replaceable companion SPBs (MB) that implement electronic marriage functions.

- Verify that as part of the installation, or reinstallation, (*i.e.*, mechanical connection to the Imaging Device and electrical initiation) an electrical and logical marriage of the companion SPB (MB) with the Imaging Device SPB is performed.
- Verify that upon initiation of the marriage a "SPBMarriage" log record is written (per [SMPTE-430-5]) and that the record contains all required data.
- Verify that upon break of the marriage a "SPBDivorce" log record is written (per [SMPTE-430-5]) and that the record contains all required data.

Procedures

1. Verify system is functional prior to breaking the marriage. This can be achieved by loading and successfully playing the composition *DCI 2K Sync Test (Encrypted)*.
2. Power down the system, locate the field-replaceable companion SPB (MB), break the marriage by disconnecting and/or removing the SPB.
3. Replace and reconnect the companion SPB, power up the system, examine the logs and verify that a "SPBDivorce" log record has been written. Absence of this entry is cause to fail this test.
4. Verify the following are contained in the SPBDivorce record:
 - a. The DeviceSourceID element contains the Certificate Thumbprint of the companion SPB.
 - b. The DeviceConnectedID element contains the Certificate Thumbprint of the Imaging Device SPB2.
 - c. The log entry contains an AuthId record.

Failure to meet requirements a, b and c above is cause to fail this test.

5. Setup a show with composition from Step 1. Verify that the system does not play the composition. Failure to meet this requirement is cause to fail this test.
6. Perform the marriage installation procedure and repeat Step 1 to verify that the system is now capable of payout. Failure to meet this requirement is cause to fail this test.
7. Examine the logs and verify that a "SPBMarriage" log entry has been written. Absence of this entry is cause to fail this test.
8. Verify the following are contained in the SPBMarriage record:
 - a. The DeviceSourceID element contains the Certificate Thumbprint of the companion SPB.
 - b. The DeviceConnectedID element contains the Certificate Thumbprint of the Imaging Device SPB2.
 - c. The log entry contains an AuthId record.

Failure to meet requirements a, b and c above is cause to fail this test.

Supporting Materials

Reference Documents	DCI-DCSS, 9.4.3.6.1, 9.4.3.6.3 SMPTE-430-5
Test Materials	<i>DCI 2K Sync Test (Encrypted)</i>

Consolidated Test Sequences

Sequence	Type	Measured Data
15.2. Integrated IMB Test Sequence	Pass/Fail	—
15.4. Integrated IMB Confidence Sequence	Pass/Fail	—
21.2. Integrated IMBO Test Sequence	Pass/Fail	—
21.4. Integrated IMBO Confidence Sequence	Pass/Fail	—

7.3.3. Companion SPB Marriage Break Key Retaining

Objective

Verify that breaking the marriage between the Media Block (MB) companion SPB (Type 1) and the Imaging Device SPB (type 2) does not zeroize the MB's long term identity keys (RSA private keys).

Procedures

Note:

This section only applies to systems that implement an Electronic Marriage, *i.e.*, those that have field replaceable companion MBs.

In the case of an MB that is married to an Imaging Device SPB and *implements dual certificates* as defined in Section 9.5.1.2 of [DCI-DCSS]:

1. Set up and play a show using the composition *DCI 2K Sync Test (Encrypted)*, keyed with *KDM for DCI 2K Sync Test (Encrypted)*.
2. Extract a signed [SMPTE-430-5] security log report from the Test Subject that includes the range of time during which the above step was carried out.
3. Using the procedures illustrated in [Section 3.1.3](#), use the **checksig** program to verify the signature of the log report collected in step 2. Note: Depending on the order of the certificates contained in the log report, the **dsig_cert.py** program may need to be used to re-order the certificates for the **checksig** program.
4. Using the procedures illustrated in [Section 3.1.3.1](#), extract the certificates in the signing chain of the log report collected in step 2. Note: This may be accomplished using the **dsig_extract.py** program.
5. Using the procedures illustrated in [Section C.2](#), use the **dc-thumbprint** program to calculate the thumbprint of the Log Signer Certificate that signed the log report collected in step 2. Record the value of the calculated thumbprint.
6. Intentionally break the marriage and remarry the companion SPB and the Imaging Device SPB (this may require support by the manufacturer).
7. Repeat steps 1 and 2 using the same composition and KDM as before. Failure to successfully play content or retrieve a log report after remarriage is cause to fail this test.
8. Repeat step 3 using the log report collected after remarriage. Failure to successfully verify the signature is cause to fail this test.

- Repeat steps 4 and 5 using the log report collected after remarriage. Confirm that the Log Signer Certificate public key thumbprint calculated after remarriage matches the one from step 5. Mismatching Log Signer Certificate public key thumbprints are cause to fail this test.

In the case of an MB that is married to a Imaging Device SPB and *implements a single certificate* as defined in Section 9.5.1.1 of [DCI-DCSS]:

- Set up and play a show using the composition *DCI 2K Sync Test (Encrypted)*, keyed with *KDM for DCI 2K Sync Test (Encrypted)*.
- Extract a signed [SMPTE-430-5] security log report from the Test Subject that includes the range of time during which the above step was carried out.
- Using the procedures illustrated in [Section 3.1.3](#), use the **checksig** program to verify the signature of the log report collected in step 2. Note: Depending on the order of the certificates contained in the log report, the **dsig_cert.py** program may need to be used to re-order the certificates for the **checksig** program.
- Using the procedures illustrated in [Section 3.1.3.1](#), extract the certificates in the signing chain of the log report collected in step 2. Note: This may be accomplished using the **dsig_extract.py** program.
- Using the procedures illustrated in [Section C.2](#), use the **dc-thumbprint** program to calculate the thumbprint of the certificate that signed the log report collected in step 2. Record the value of the calculated thumbprint.
- Intentionally break the marriage and remarry the companion SPB and the Imaging Device SPB (this may require support by the manufacturer).
- Repeat steps 1 and 2 using the same composition and KDM as before. Failure to successfully play content or retrieve a log report after remarriage is cause to fail this test.
- Repeat step 3 using the log report collected after remarriage. Failure to successfully verify the signature is cause to fail this test.
- Repeat steps 4 and 5 using the log report collected after remarriage. Confirm that the certificate thumbprint calculated after remarriage matches the one from step 5. Mismatching public key thumbprints are cause to fail this test.

Supporting Materials

Reference Documents	DCI-DCSS, 9.4.3.6.3, 9.5.1.2
Test Materials	<i>DCI 2K Sync Test (Encrypted)</i> <i>KDM for DCI 2K Sync Test (Encrypted)</i>

Consolidated Test Sequences

Sequence	Type	Measured Data
----------	------	---------------

15.4. Integrated IMB Confidence Sequence	Pass/Fail	—
21.2. Integrated IMBO Test Sequence	Pass/Fail	—

7.3.4. Deleted Section

The section "Remote SPB Clock Adjustment" was deleted. The section number is maintained here to preserve the numbering of subsequent sections.

7.4. Link Decryptor Block

7.4.1. Deleted Section

The section "LDB without Electronic Marriage" was deleted. The section number is maintained here to preserve the numbering of subsequent sections.

7.4.2. Deleted Section

The section "LDB TLS Session Constraints" was deleted. The section number is maintained here to preserve the numbering of subsequent sections.

7.4.3. Deleted Section

The section "LDB Time-Awareness" was deleted. The section number is maintained here to preserve the numbering of subsequent sections.

7.4.4. Deleted Section

The section "LDB ASM Conformity" was deleted. The section number is maintained here to preserve the numbering of subsequent sections.

7.4.5. Deleted Section

The section "LDB Key Storage" was deleted. The section number is maintained here to preserve the numbering of subsequent sections.

7.4.6. Deleted Section

The section "LDB Key Purging" was deleted. The section number is maintained here to preserve the numbering of subsequent sections.

7.4.7. Deleted Section

The section "LDB Logging" was deleted. The section number is maintained here to preserve the numbering of subsequent sections.

7.5. Image Reproduction

7.5.1. Deleted Section

The section "Projector Overlay" was deleted. The section number is maintained here to preserve the numbering of subsequent sections.

7.5.2. Deleted Section

The section "Projector Lens" was deleted. The section number is maintained here to preserve the numbering of subsequent sections.

7.5.3. Imaging Device Pixel Count/Structure

Objective

Verify that the sampling structure of the displayed picture array (pixel count of the imaging device) is equal that of the respective specified image containers (either 4096 x 2160 or 2048 x 1080).

Procedures

Note: Prior to performing the following procedures, it is necessary to verify that any electronic rescaling of the image is fully disabled. This may include turning off resizing, keystone correction, filters and/or other related processes.

- For 2K Projectors: Display the test composition *Pixel Structure Pattern S 2k* Verify that the complete set of 16x16 and 8x8 pixel blocks is displayed.
- For 4K Projectors and Direct View Displays: Display the test pattern *Pixel Structure Pattern S 4k*. Verify that the complete set of 16x16 pixel blocks is displayed.

Deviation from the expected image is cause to fail this test. The figures below illustrate the features of the pixel array test pattern. The 2k pattern consists of a 128 x 67 grid of 16 x 16 pixel blocks as illustrated in [Figure 7.1](#). A single-pixel white border surrounds the pattern. Each 16 x 16 block contains a horizontal and vertical location index encoded as a 8-bit binary ladder, with the MSb being at the top or left side of the vertical and horizontal ladders, respectively. The example below shows a block with index $X = 81$, $Y = 37$. The pixel at location 0,0 in the block is located at pixel $x = 1296 = X * 16$, $y = 592 = Y * 16$ on the screen. The bottom 8 pixels of the 2k pattern consist of similar, un-indexed 8 x 8 patterns as illustrated in [Figure 7.2](#).

The 4k pattern consists of a 256 x 135 grid of 16 x 16 pixel arrays. A single-pixel white border surrounds the pattern.

Within each block, color-coded bands mark pixel positions. The bands may have North, South, East or West orientation (the example blocks have South orientation). Pixel positions are coded left to right (top to bottom for East and West orientations) with the following color sequence: brown, red, orange, yellow, green, blue, violet, gray.

Note: North, South, East and West orientations are provided in the test materials set to support investigation of anomalies.

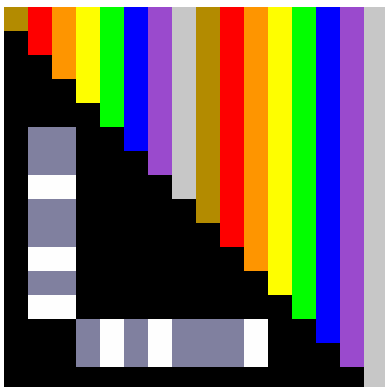

Figure 7.1. Pixel Structure 16 x 16 Array



Figure 7.2. Pixel Structure 8 x 8 Array

Warning: the patterns displayed during this test can cause vertigo in some people. People who are sensitive to such optical stimuli should not view the test material.

Supporting Materials

Reference Documents	DCI-DCSS, 8.2.2.6, 8.2.2.7 [DV-ADD]
Test Materials	<i>Pixel Structure Pattern N 2k</i> <i>Pixel Structure Pattern S 2k</i> <i>Pixel Structure Pattern E 2k</i> <i>Pixel Structure Pattern W 2k</i> <i>Pixel Structure Pattern N 4k</i> <i>Pixel Structure Pattern S 4k</i> <i>Pixel Structure Pattern E 4k</i> <i>Pixel Structure Pattern W 4k</i>

Consolidated Test Sequences

Sequence	Type	Measured Data
24.2. SDR Projector Test Sequence	Pass/Fail	—
24.4. SDR Projector Confidence Sequence	Pass/Fail	—
26.2. HDR Direct View Display Test Sequence	Pass/Fail	—
26.4. HDR Direct View Display Confidence Sequence	Pass/Fail	—
27.2. SDR Direct View Display Test Sequence	Pass/Fail	—
27.4. SDR Direct View Display Confidence Sequence	Pass/Fail	—
28.2. HDR Projector Test Sequence	Pass/Fail	—
28.4. HDR Projector Confidence Sequence	Pass/Fail	—

7.5.4. Deleted Section

The section "Projector Spatial Resolution and Frame Rate Conversion" was deleted. The section number is maintained here to preserve the numbering of subsequent sections.

7.5.5. Deleted Section

The section "White Point Luminance and Uniformity" was deleted. The section number is maintained here to preserve the numbering of subsequent sections.

7.5.6. Deleted Section

The section "White Point Chromaticity and Uniformity" was deleted. The section number is maintained here to preserve the numbering of subsequent sections.

7.5.7. Deleted Section

The section "Sequential Contrast" was deleted. The section number is maintained here to preserve the numbering of subsequent sections.

7.5.8. SDR Intra-frame Contrast

Objective

Verify that the Imaging Device maintains white and black luminance when a non-uniform picture is presented.

Procedures

1. Ensure that the Imaging Device setup and test environment requirements detailed in 7.1. Test Environment for Image Measurements have been performed.
2. Display the checkerboard test pattern *Intra-Frame Contrast Sequence*.
3. Measure L_{WL} , L_{WR} , L_{KL} and L_{KR} according to:
 - o the *checkerboard luminance & contrast (n×m)* procedure at [ICDM IDMS], if the Test Subject is a Direct View Display; or
 - o the *checkerboard contrast ratio* procedure at [ICDM IDMS], if the Test Subject is a Projector; or
4. Verify that:
 - o if the Test Subject is a Direct View Display, L_{WL} and L_{WR} are each equal to 48.0 ± 3.5 cd/m², and L_{KL} and L_{KR} are each within the range [0.01, 0.024] cd/m²; or
 - o if the Test Subject is a Projector, L_{WL} and L_{WR} are each equal to 48.0 ± 3.5 cd/m², and L_{KL} and L_{KR} each do not exceed 0.52 cd/m².

Any verification that fails is cause to fail this test.

Supporting Materials

Reference Documents	DCI-DCSS, 8.3.4.8 SMPTE-431-2
Test Equipment	Spectroradiometer

Test Materials

Intra-Frame Contrast Sequence

Consolidated Test Sequences

Sequence	Type	Measured Data
24.2. SDR Projector Test Sequence	Pass/Fail	—
26.2. HDR Direct View Display Test Sequence	Pass/Fail	—
27.2. SDR Direct View Display Test Sequence	Pass/Fail	—
28.2. HDR Projector Test Sequence	Pass/Fail	—

7.5.9. Grayscale Tracking

Objective

Using the black-to-white gray and the black-to-dark gray step-scale test patterns, verify that the entire step-scale appears neutral without any visible color non-uniformity or non-monotonic luminance steps in the test pattern.

Procedures

Note: Prior to taking measurements, ensure that the test environment requirements detailed in [Section 7.1](#) have been performed.

1. Power-down the Test Subject. Alternatively, the douser can be closed if the Test Subject is a Projector.
2. Use a **Spectroradiometer** to measure and record the Luminance of the ambient light reflected from the screen.
3. Power-up the Test Subject. Alternatively, the douser can be open if the Test Subject is a Projector.
4. Display no image or display black code values, and, using a **Spectroradiometer**, measure and record the Luminance of the light reflected from the screen.
5. Play back the DCP *DCI White Steps* (black-to-white gray step-scale test pattern).
6. For each of the ten steps of the pattern listed in Table A-2 of [SMPTE-431-2], measure and record the Output Luminance and Chromaticity Coordinates with a **Spectroradiometer**.
7. The entire step-scale should appear neutral without any visible color non-uniformity or non-monotonic luminance steps in the test pattern. Record the presence of any perceived deviation from a neutral scale.
8. Play back the DCP *DCI Gray Steps* (black-to-dark gray step-scale test pattern).
9. For each of the ten steps of the pattern listed in Table A-3 of [SMPTE-431-2], measure and record the Luminance and Chromaticity Coordinates with a **Spectroradiometer**.
10. The entire step-scale should appear neutral without any visible color non-uniformity or non-monotonic luminance steps in the test pattern. Record the presence of any perceived deviation from a neutral scale.

Supporting Materials

Reference Documents	DCI-DCSS, 8.3.4.9 SMPTE-431-2
Test Equipment	Spectroradiometer
Test Materials	<i>DCI White Steps</i> <i>DCI Gray Steps</i>

Consolidated Test Sequences

Sequence	Type	Measured Data
24.2. SDR Projector Test Sequence	Data only	—
26.2. HDR Direct View Display Test Sequence	Data only	—
27.2. SDR Direct View Display Test Sequence	Data only	—
28.2. HDR Projector Test Sequence	Data only	—

7.5.10. SDR Contouring

Objective

Confirm the Imaging Device exhibits no visible contouring when presenting an SDR composition.

Procedures

1. Ensure that the Imaging Device setup and test environment requirements detailed in [7.1. Test Environment for Image Measurements](#) have been performed.
2. Play back *SDR Dark Gray Scale* and measure, using a **Spectroradiometer**, the luminance L_i at the center of the screen of each full-screen gray patch.
3. Calculate the set of second approximate derivatives from the set of measurements $\{L_i\}$ according to the *slope monotonicity of gray scale* procedure at [ICDM IDMS].
4. Verify that all the second approximate derivatives are greater than 0.

Any verification that fails is cause to fail this test.

Supporting Materials

Reference Documents	DCI-DCSS, 8.3.3 [SMPTE-431-2]
Test Materials	<i>SDR Dark Gray Scale</i>

Consolidated Test Sequences

24.2. SDR Projector Test Sequence	Pass/Fail	—
26.2. HDR Direct View Display Test Sequence	Pass/Fail	—
27.2. SDR Direct View Display Test Sequence	Pass/Fail	—
28.2. HDR Projector Test Sequence	Pass/Fail	—

7.5.11. SDR Transfer Function

Objective

Verify that the correct SDR transfer function is used by the imaging device.

Procedures

Note: Prior to taking measurements, ensure that the setup and test environment requirements detailed in [Section 7.1](#) have been performed.

1. Display *2K Full SDR Black* and, using a **Spectroradiometer**, measure the output luminance to a precision of 1 mcd/m², and record the result as the *screen black level*.
2. Play back the DCP *DCI White Steps*.
3. For each of the ten steps of the pattern listed in Table A-2 of [SMPTE-431-2], measure the output luminance with a **Spectroradiometer**, subtract the *screen black level* obtained in step (1), and verify that the result is within the tolerance specified in [Table 7.5](#).
4. Play back the DCP *DCI Gray Steps*.
5. For each of the ten steps of the pattern listed in Table A-3 of [SMPTE-431-2], measure the output luminance with a **Spectroradiometer**, subtract the *screen black level* obtained in step (1), and verify that the result is within the tolerance specified in [Table 7.5](#).

Any verification that fails is cause to fail this test.

Table 7.5.11(a) Black-to-white gray step-scale test pattern nominal luminance values

Step Number	Nominal Luminance above the Screen Black Level (cd/m ²)	Tolerance
1	0.121	±5%
2	0.731	±5%
3	2.098	±3%
4	4.432	±3%
5	7.917	±3%
6	12.718	±3%
7	18.988	±3%
8	26.870	±3%
9	36.497	±3%
10	47.999	±3%

Table 7.5.11(b) Black-to-dark gray step-scale test pattern nominal luminance values

Step Number	Nominal Luminance above the Screen Black Level (cd/m ²)	Tolerance
1	0.006	±20%
2	0.038	±5%
3	0.111	±5%
4	0.234	±5%
5	0.418	±5%
6	0.670	±5%
7	1.002	±3%
8	1.418	±3%
9	1.928	±3%
10	2.531	±3%

Supporting Materials

Reference Documents	DCI-DCSS, 9.3.4.11 SMPTE-431-2 [DV-ADD]
Test Equipment	Spectroradiometer
Test Materials	<i>DCI White Steps</i> <i>DCI Gray Steps</i> <i>2K Full SDR Black</i>

Consolidated Test Sequences

Sequence	Type	Measured Data
24.2. SDR Projector Test Sequence	Pass/Fail	—
26.2. HDR Direct View Display Test Sequence	Pass/Fail	—
27.2. SDR Direct View Display Test Sequence	Pass/Fail	—
28.2. HDR Projector Test Sequence	Pass/Fail	—

7.5.12. SDR Color Accuracy

Objective

Verify that all colors are accurately reproduced within the tolerances as specified in [SMPTE-431-2].

Procedures

1. Setup the Imaging Device and test environment according to 7.1. Test Environment for Image Measurements.
2. Using *Color Accuracy Series*, measure and record the luminance and chromaticity coordinates for the following patches, according to the *full-screen arbitrary color (R, G, B)* procedure at [ICDM IDMS]:

Red-1

- o *Green-1*
- o *Blue-1*

3. Verify that the measured chromaticity coordinates for each of the patches are equal to the *Red*, *Green* and *Blue* reference values for *Color Accuracy* that are specified at [SMPTE-431-2], Table A.1, within review room tolerances.

4. Verify that the measured luminance for each of the patches is $\pm 3\%$ of the *Output Luminance* values specified at [SMPTE-431-2], Table A.4.

Any measurement outside of specified tolerances is caused to fail this test.

Supporting Materials

Reference Documents	DCI-DCSS, 8.3.3 SMPTE-431-2
Test Equipment	Spectroradiometer
Test Materials	<i>Color Accuracy Series</i>

Consolidated Test Sequences

Sequence	Type	Measured Data
24.2. SDR Projector Test Sequence	Pass/Fail	—
26.2. HDR Direct View Display Test Sequence	Pass/Fail	—
27.2. SDR Direct View Display Test Sequence	Pass/Fail	—
28.2. HDR Projector Test Sequence	Pass/Fail	—

7.5.13. Projector Test Environment

Objective

Record information about the test environment in which the reported projector measurements were made.

Procedures

1. Record the distance between the front of the projector lens and the center of the screen.
2. Record the approximate vertical angle of incidence of the front of the projector lens to the center of the screen.
3. Record the approximate horizontal angle of incidence of the front of the projector lens to the center of the screen.
4. Record the distance between the front of the **Spectroradiometer** lens and the center of the screen.

5. Record the approximate vertical angle of incidence of the front of the **Spectroradiometer** lens to the center of the screen.
6. Record the approximate horizontal angle of incidence of the front of the **Spectroradiometer** lens to the center of the screen.
7. Record the size of the screen.
8. Record the approximate gain of the screen.
9. Record the perforation configuration of the screen.
10. With the projector lamp switched off (or doused), record the luminance at the center of the screen in units of Cd/m².

Consolidated Test Sequences

Sequence	Type	Measured Data
24.2. SDR Projector Test Sequence	Pass/Fail	All data recorded per the test procedure
28.2. HDR Projector Test Sequence	Pass/Fail	All data recorded per the test procedure

7.5.14. HDR White Luminance and Chromaticity

Objective

Verify that the luminance and chromaticity of HDR white are within tolerances:

- at the center of the Imaging Device; and
- at the edges of the Imaging Device.

Procedures

1. Ensure that the Imaging Device setup and test environment requirements detailed in 7.1. Test Environment for Image Measurements have been performed.
2. Display the white frame of *HDR Sequential Contrast and Uniformity Sequence*.
3. Measure the luminance and chromaticity coordinates according to the *full-screen arbitrary color (R, G, B)* procedure at [ICDM IDMS].
4. Verify that the measured luminance and chromaticity coordinates are within the *center luminance* and *center chromaticity* tolerances, respectively, specified for specified at Table 7.5 for the Test Subject. Any measurement outside of the specified tolerances is caused to fail this test.

5. Measure the luminance nonuniformity \mathcal{N} and maximum chromaticity difference $\Delta u'v'$ according to the *sampled vantage-point uniformity* procedure at [ICDM IDMS].
6. Verify that \mathcal{N} and $\Delta u'v'$ do not exceed their respective maximum values specified at [Table 7.5](#) for the Test Subject.

Any verification that fails is cause to fail this test.

Table 7.5.14(a) HDR White (Peak)

Parameter	Test Subject	
	Projector	Direct View Display
Center luminance (cd/m ²)	299.6 ± 18	299.6 ± 9
Center chrominance (x, y)	(0.3127 ± 0.002, 0.3290 ± 0.002)	

Table 7.5.14(b) HDR White (Angular Nonuniformity)

Parameter	Test Subject	
	Projector	Direct View Display
Maximum \mathcal{N}	15%	6%
Maximum $\Delta u'v'$	0.0182	

Supporting Materials

Reference Documents	[ICDM IDMS] [DCI-HDR] [DV-ADD]
Test Equipment	Spectroradiometer
Test Materials	<i>HDR Sequential Contrast and Uniformity Sequence</i>

Consolidated Test Sequences

Sequence	Type	Measured Data
26.2. HDR Direct View Display Test Sequence	Pass/Fail	—
28.2. HDR Projector Test Sequence	Pass/Fail	—

7.5.15. SDR White Luminance and Chromaticity

Objective

Verify that the luminance and chromaticity of SDR white are within tolerances:

- at the center of the Imaging Device; and
- at the edges of the Imaging Device.

Procedures

1. Ensure that the Imaging Device setup and test environment requirements detailed in 7.1. Test Environment for Image Measurements have been performed. For the remainder of this test procedure, the **Spectroradiometer** shall be positioned as specified at 7.1.1 General, disregarding positioning recommendations made at [ICDM IDMS].
2. Display the white frame of *Sequential Contrast and Uniformity Sequence*.
3. Measure the luminance and chromaticity coordinates according to the *full-screen arbitrary color (R, G, B)* procedure at [ICDM IDMS].
4. Verify that the measured luminance and chromaticity coordinates are within the *center luminance* and *center chromaticity* tolerances, respectively, specified for specified at Table 7.5 for the Test Subject. Any measurement outside of the specified tolerances is caused to fail this test.
5. Measure the luminance nonuniformity N and maximum chromaticity difference $\Delta u'v'$ according to the *sampled vantage-point uniformity* procedure at [ICDM IDMS].
6. Verify that N and $\Delta u'v'$ do not exceed their respective maximum values specified at Table 7.5 for the Test Subject.

Any verification that fails is cause to fail this test.

Table 7.5.15(a) SDR White (Peak)

Parameter	Test Subject	
	Projector	Direct View Display
Center luminance (cd/m ²)	48.0 ± 3.5	
Center chrominance (x, y)	(0.314 ± 0.002, 0.351 ± 0.002)	

Table 7.5.15(b) SDR White (Angular Nonuniformity)

Parameter	Test Subject	
	Projector	Direct View Display
Maximum N	20%	6%
Maximum $\Delta u'v'$	0.0171	

Supporting Materials

Reference Documents	[ICDM IDMS] [DV-ADD] DCI-DCSS, 8.3.4.3, 8.3.4.4 SMPTE-431-1
Test Equipment	Spectroradiometer
Test Materials	<i>Sequential Contrast and Uniformity Sequence</i>

Consolidated Test Sequences

Sequence	Type	Measured Data
24.2. SDR Projector Test Sequence	Pass/Fail	—
26.2. HDR Direct View Display Test Sequence	Pass/Fail	—
27.2. SDR Direct View Display Test Sequence	Pass/Fail	—
28.2. HDR Projector Test Sequence	Pass/Fail	—

7.5.16. HDR Color Luminance and Chromaticity

Objective

Confirm that HDR color reproduction, as measured at the center of the Imaging Device, is within tolerances.

Procedures

1. Setup the Imaging Device and test environment according to 7.1. Test Environment for Image Measurements.
2. Using *HDR Color Accuracy Series*, measure and record the luminance and chromaticity coordinates for the following Patch Code Values, according to the *full-screen arbitrary color (R, G, B)* procedure at [ICDM IDMS]:
 - o *Red-1*
 - o *Green-1*
 - o *Blue-1*
3. Verify that the measured chromaticity coordinates for *Red-1*, *Green-1* and *Blue-1* are equal to the reference values for *Color Accuracy* that are specified at [DCI-HDR], within the review room tolerances corresponding to the Test Subject.
4. Verify that the measured luminance for *Red-1*, *Green-1* and *Blue-1* are within the tolerances specified at Table 7.5.

Any measurement outside of specified tolerances is caused to fail this test.

Table 7.5.16 Target HDR color luminances and chromaticities

Patch	Nominal values (cd/m ²)	Tolerances	
		Projector	Direct View Display
Red-1	68.13	±6%	±3%
Green-1	207.35		
Blue-1	23.86		

Supporting Materials

Reference Documents	[ICDM IDMS]
---------------------	-------------

	[DCI-HDR] [DV-ADD]
Test Equipment	Spectroradiometer
Test Materials	<i>HDR Color Accuracy Series</i>

Consolidated Test Sequences

Sequence	Type	Measured Data
26.2. HDR Direct View Display Test Sequence	Pass/Fail	—
28.2. HDR Projector Test Sequence	Pass/Fail	—

7.5.17. HDR Minimum Active Black Level

Objective

Confirm that the minimum active black level as measured in the center of the Imaging Device is within tolerances.

Procedures

1. Ensure that the Imaging Device setup and test environment requirements detailed in [7.1. Test Environment for Image Measurements](#) have been performed.
2. Display the black frame of *HDR Sequential Contrast and Uniformity Sequence*.
3. Measure the luminance according to the *full-screen black* procedure at [ICDM IDMS].
4. Verify that each measured luminance is equal to the nominal value for *Minimum Active Black Level* specified at [DCI-HDR], within the review room tolerances corresponding to the Test Subject. Any measurement outside of the specified tolerances is caused to fail this test.

Supporting Materials

Reference Documents	[ICDM IDMS] [DCI-HDR] [DV-ADD]
Test Equipment	Spectroradiometer
Test Materials	<i>HDR Sequential Contrast and Uniformity Sequence</i>

Consolidated Test Sequences

Sequence	Type	Measured Data
26.2. HDR Direct View Display Test Sequence	Pass/Fail	—
28.2. HDR Projector Test Sequence	Pass/Fail	—

7.5.18. SDR Inactive Black Level (Direct View Display)

Objective

1. Verify that pixels outside the decoded image area are not emitting any light.
2. Verify that pixels outside the area specified by the MainPictureActiveArea item of the CPL metadata are not emitting any light.

Procedures

1. Ensure that the Imaging Device setup and test environment requirements detailed in [7.1. Test Environment for Image Measurements](#) have been performed.
2. For each of the following test materials, display the material and verify by visual inspection that: (a) registration marks are visible and (b) pixels outside the rectangular area delineated by the registration marks are not emitting any light:
 - o *2K Full SDR Black with Marks*
 - o *2K Scope SDR Black with Marks*
 - o *2K Flat SDR Black with Marks*
 - o *4K Full SDR Black with Marks*
 - o *4K Scope SDR Black with Marks*
 - o *4K Flat SDR Black with Marks*

Any verification that fails is cause to fail this test.

3. For each of the following test materials, display the material and verify by visual inspection that: (a) registration marks are visible and (b) no red pixels are visible:
 - o *2K Full SDR Black with Active Area*
 - o *2K Scope SDR Black with Active Area*
 - o *2K Flat SDR Black with Active Area*
 - o *4K Full SDR Black with Active Area*
 - o *4K Scope SDR Black with Active Area*
 - o *4K Flat SDR Black with Active Area*

Any verification that fails is cause to fail this test.

Supporting Materials

Reference Documents	[DV-ADD]
Test Materials	2K Full SDR Black with Marks 2K Scope SDR Black with Marks 2K Flat SDR Black with Marks 4K Full SDR Black with Marks 4K Scope SDR Black with Marks 4K Flat SDR Black with Marks 2K Full SDR Black with Active Area 2K Scope SDR Black with Active Area 2K Flat SDR Black with Active Area 4K Full SDR Black with Active Area 4K Scope SDR Black with Active Area 4K Flat SDR Black with Active Area

Consolidated Test Sequences

Sequence	Type	Measured Data
26.2. HDR Direct View Display Test Sequence	Pass/Fail	—
27.2. SDR Direct View Display Test Sequence	Pass/Fail	—

7.5.19. Horizontal and Vertical Full Screen Off-Axis Uniformity (Direct View Display)

Objective

Verify the full screen off-axis uniformity performance of the Imaging Device.

Procedures

1. Ensure that the Imaging Device setup and test environment requirements detailed in 7.1. Test Environment for Image Measurements have been performed.
2. Display the white frame from *Sequential Contrast and Uniformity Sequence* and, for each of the angular positions specified in Table 7.1:
 - o measure the *luminance change ratio* according to the *viewing-angle luminance change ratio* procedure at [ICDM IDMS].
 - o measure the *viewing-angle color variation* according to the *viewing-angle color variation* procedure at [ICDM IDMS].
3. Verify that each of the measured *luminance change ratio* and *viewing-angle color variation* satisfy the tolerance specified at Table 7.1.

Any verification that fails is cause to fail this test.

Table 7.1. Measurement positions and tolerances for horizontal and vertical full screen off-axis performance measurements

Angular positions	Luminance change ratio tolerance	Viewing-angle color variation tolerance
+10° vertically (up)	Full Screen Vertical Off-Axis Luminance Uniformity at [DV-ADD]	Full Screen Vertical Off-Axis White Chromaticity Uniformity at [DV-ADD]
-35° vertically (down)		
-60° horizontally (left)	Full Screen Horizontal Off-Axis Luminance Uniformity at [DV-ADD]	Full Screen Horizontal Off-Axis White Chromaticity Uniformity at [DV-ADD]
+60° horizontally (right)		

Supporting Materials

Reference Documents	[ICDM IDMS] [DV-ADD]
Test Equipment	Spectroradiometer
Test Materials	<i>Sequential Contrast and Uniformity Sequence</i>

Consolidated Test Sequences

Sequence	Type	Measured Data
26.2. HDR Direct View Display Test Sequence	Pass/Fail	—
27.2. SDR Direct View Display Test Sequence	Pass/Fail	—

7.5.20. Stereoscopic Extinction Ratio

Objective

Confirm that, when reproducing stereoscopic presentations, the Imaging Device achieves the required minimum extinction ratio.

Procedures

This test procedure only applies to a Test Subject that supports stereoscopic presentations.

1. Ensure that the Imaging Device setup and test environment requirements detailed in [7.1. Test Environment for Image Measurements](#) have been performed.
2. Using *Stereoscopic SDR Contrast Test Patterns*, measure the extinction ratios χ_{sysL} and χ_{sysR} according to the *stereoscopic extinction ratio & crosstalk* procedure at [ICDM IDMS].
3. Verify that χ_{sysL} and χ_{sysR} each equals or exceeds the *Tolerance* for the *Stereoscopic Extinction Ratio* specified at [DV-ADD].

Any verification that fails is cause to fail this test.

Supporting Materials

Reference Documents	[ICDM IDMS] [DV-ADD]
Test Equipment	Spectroradiometer
Test Materials	<i>Stereoscopic SDR Contrast Test Patterns</i>

Consolidated Test Sequences

Sequence	Type	Measured Data
26.2. HDR Direct View Display Test Sequence	Pass/Fail	—
27.2. SDR Direct View Display Test Sequence	Pass/Fail	—

7.5.21. SDR Stereoscopic Peak White Luminance

Objective

Confirm that, when reproducing stereoscopic presentations, the Imaging Device achieves the required SDR peak white luminance.

Procedures

This test procedure only applies to a Test Subject that supports SDR stereoscopic presentations.

1. Ensure that the Imaging Device setup and test environment requirements detailed in 7.1. Test Environment for Image Measurements have been performed.
2. Using *Stereoscopic SDR Contrast Test Patterns*, measure the average stereo luminance L_{ave} according to the *stereoscopic luminance & luminance difference* procedure at [ICDM IDMS].
3. Verify that L_{ave} is within the tolerances for the *Stereoscopic Peak White Luminance* specified at [DV-ADD].

Any verification that fails is cause to fail this test.

Supporting Materials

Reference Documents	[ICDM IDMS] [DV-ADD]
Test Equipment	Spectroradiometer
Test Materials	<i>Stereoscopic SDR Contrast Test Patterns</i>

Consolidated Test Sequences

Sequence	Type	Measured Data
----------	------	---------------

26.2. HDR Direct View Display Test Sequence	Pass/Fail	—
27.2. SDR Direct View Display Test Sequence	Pass/Fail	—

7.5.22. Surface Reflectivity (Direct View Display)

Objective

- Verify that the diffuse surface reflectivity of the imaging device is within limits
- Verify that the specular surface reflectivity of the imaging device is within limits

Procedures

Note:

If the measurement device or procedure reports the diffuse reflectivity at different optical wavelengths, the weighted average using the CIE Y Color Matching Function shall be used to combine different values at different wavelengths into a single diffuse reflectivity value that is photometrically weighted.

1. Ensure that the Imaging Device setup and test environment requirements detailed in 7.1. Test Environment for Image Measurements have been performed.
2. With the Imaging Device turned off, measure the *reflectance with specular excluded*, $\rho_{\theta/de}$, according to the *sampling-sphere implementation (specular excluded)* procedure at [ICDM IDMS].
3. Verify that $\rho_{\theta/de}$ is less than or equal to the *Diffuse Reflectivity* specified at [DV-ADD].
4. With the Imaging Device turned off, measure the *reflectance*, $\rho_{\theta/di}$, according to the *sampling-sphere implementation* procedure at [ICDM IDMS].
5. Verify that $\rho_{\theta/di} - \rho_{\theta/de}$ is less than or equal to the *Spectral Reflectivity* specified at [DV-ADD].

Any verification that fails is cause to fail this test.

Supporting Materials

Reference Documents	[ICDM IDMS] [DV-ADD]
Test Equipment	Spectroradiometer

Consolidated Test Sequences

Sequence	Type	Measured Data
26.2. HDR Direct View Display Test Sequence	Pass/Fail	—
27.2. SDR Direct View Display Test Sequence	Pass/Fail	—

7.5.23. Vignetting (Direct View Display)

Objective

Verify that the imaging device does not exhibit vignetting.

Procedures

1. Ensure that the Imaging Device setup and test environment requirements detailed in 7.1. Test Environment for Image Measurements have been performed.
2. Using the full-frame white target from *Sequential Contrast and Uniformity Sequence*, measure the nonuniformity \mathcal{N} according to the *sampled uniformity* procedure at [ICDM IDMS].
3. Verify that \mathcal{N} meets the tolerance for the *Full-Screen Sampled Nonuniformity* specified at [DV-ADD].

Any verification that fails is cause to fail this test.

Supporting Materials

Reference Documents	[ICDM IDMS] [DV-ADD]
Test Equipment	Spectroradiometer
Test Materials	<i>Sequential Contrast and Uniformity Sequence</i>

Consolidated Test Sequences

Sequence	Type	Measured Data
26.2. HDR Direct View Display Test Sequence	Pass/Fail	—
27.2. SDR Direct View Display Test Sequence	Pass/Fail	—

7.5.24. SDR Stereoscopic Minimum Active Black Level

Objective

Confirm that the stereoscopic display system achieves the required SDR minimum active black level.

Procedures

This test procedure only applies to a Test Subject that supports SDR stereoscopic presentations.

1. Ensure that the Imaging Device setup and test environment requirements detailed in 7.1. Test Environment for Image Measurements have been performed.
2. Using *Stereoscopic SDR Contrast Test Patterns*, measure the left eye black level, $L_{\mathcal{L}KK}$, and the right eye black level, $R_{\mathcal{R}KK}$, according to the *stereoscopic contrast ratio* procedure at [ICDM IDMS].
3. Verify that both $L_{\mathcal{L}KK}$ and $R_{\mathcal{R}KK}$ are within the limits for the *Stereoscopic Minimum Active Black Level* specified at [DV-ADD].

Any verification that fails is cause to fail this test.

Supporting Materials

Reference Documents	[ICDM IDMS] [DV-ADD]
Test Equipment	Spectroradiometer
Test Materials	<i>Stereoscopic SDR Contrast Test Patterns</i>

Consolidated Test Sequences

Sequence	Type	Measured Data
26.2. HDR Direct View Display Test Sequence	Pass/Fail	—
27.2. SDR Direct View Display Test Sequence	Pass/Fail	—

7.5.25. Image Upscaling Artifacts

Objective

Confirm that the imaging system does not exhibit upscaling artifacts.

Procedures

1. Ensure that the Imaging Device setup and test environment requirements detailed in [7.1. Test Environment for Image Measurements](#) have been performed.
2. Display *4K Scaling Test Patterns*.
3. Verify that, when viewed from a distance of one screen height from the imaging device, the displayed image appear as illustrated at [Figure A.2.254](#) and is free of artifacts, including spatial discontinuity artifacts (jaggies), ringing artifacts and aliasing artifacts, as illustrated in [Figure 7.25\(a\)](#), [Figure 7.25\(b\)](#) and [Figure 7.25\(c\)](#).

Any verification that fails is cause to fail this test.

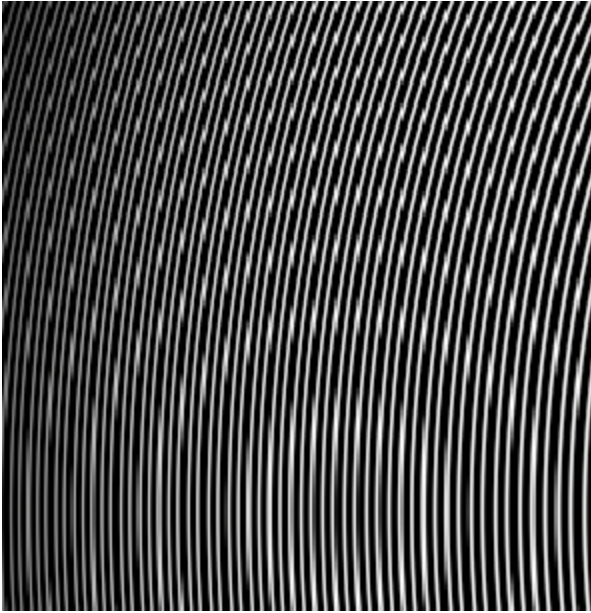

Figure 7.25(a). Sample aliasing artifacts

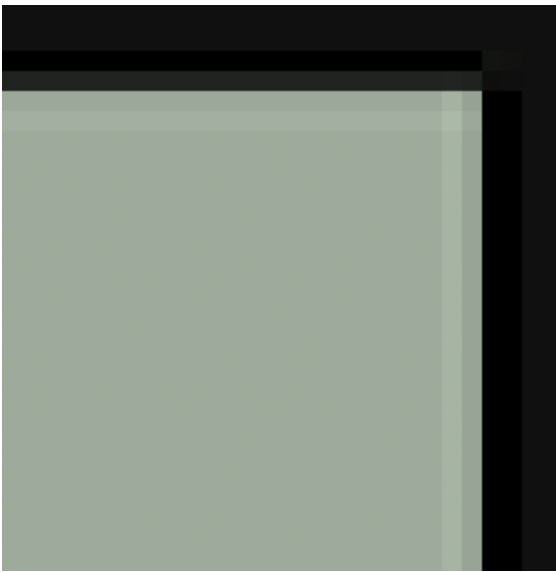

Figure 7.25(b). Sample ringing artifacts

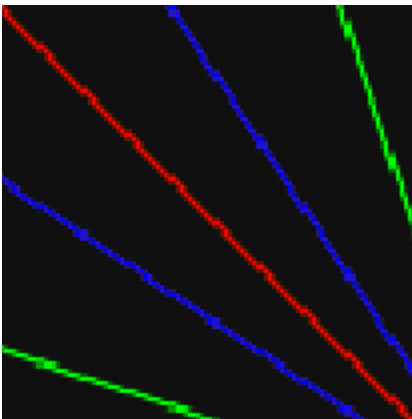

Figure 7.25(c). Sample spatial discontinuities (jaggies)

Supporting Materials

Reference Documents	[ICDM IDMS] [DV-ADD]
Test Materials	<i>4K Scaling Test Patterns</i>

Consolidated Test Sequences

Sequence	Type	Measured Data
26.2. HDR Direct View Display Test Sequence	Pass/Fail	—
27.2. SDR Direct View Display Test Sequence	Pass/Fail	—

7.5.26. SDR Stereoscopic Color Accuracy

Objective

Verify that, when reproducing a stereoscopic presentation, the Imaging Device reproduces colors within the tolerances specified in [SMPTE-431-2].

Procedures

1. Setup the Imaging Device and test environment according to 7.1. Test Environment for Image Measurements.
2. Using *Stereoscopic Color Accuracy Series*, measure and record the luminance and chromaticity coordinates for the following patches, according to the *full-screen arbitrary color (R, G, B)* procedure at [ICDM IDMS]:
 - o *Red-1*
 - o *Green-1*
 - o *Blue-1*
3. Verify that the measured chromaticity coordinates for each of the patches are equal to the *Red*, *Green* and *Blue* reference values for *Color Accuracy* that are specified at [SMPTE-431-2], Table A.1, within review room tolerances.
4. Verify that the measured luminance for each of the patches is $\pm 3\%$ of the *Output Luminance* values specified at [SMPTE-431-2], Table A.4.

Any measurement outside of specified tolerances is caused to fail this test.

Supporting Materials

Reference Documents	DCI-DCSS, 8.3.3 SMPTE-431-2
----------------------------	--------------------------------

	[DV-ADD]
Test Equipment	Spectroradiometer
Test Materials	<i>Stereoscopic Color Accuracy Series</i>

Consolidated Test Sequences

Sequence	Type	Measured Data
26.2. HDR Direct View Display Test Sequence	Pass/Fail	—
27.2. SDR Direct View Display Test Sequence	Pass/Fail	—

7.5.27. Sub-pixel Spatial Coincidence (Direct View Display)

Objective

Verify that the spatial arrangement of the color primary elements do not introduce objectionable geometric anomalies such as fringing artifacts.

Procedures

1. Ensure that the Imaging Device setup and test environment requirements detailed in [7.1. Test Environment for Image Measurements](#) have been performed.
2. Using *4K White Lines*, verify that no color fringing artifacts are visible. [Figure 7.5](#) illustrates one example of fringing artifacts where a nominally vertical white line appears, as seen from the normal seating area, as disjointed line segments of varying colors.

Any verification that fails is cause to fail this test.

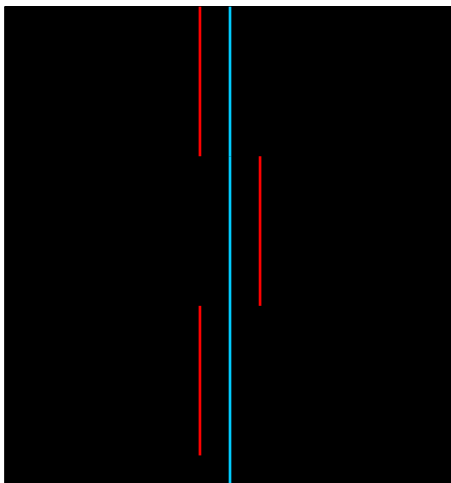

Figure 7.5.27 Illustration of a fringing artifact (not to scale)

Supporting Materials

Reference Documents	[DV-ADD]
Test Materials	

Consolidated Test Sequences

Sequence	Type	Measured Data
26.2. HDR Direct View Display Test Sequence	Pass/Fail	—
27.2. SDR Direct View Display Test Sequence	Pass/Fail	—

7.5.28. HDR Transfer Function

Objective

Verify that the correct HDR transfer function is used by the Imaging Device.

Procedures

Note: Prior to taking measurements, ensure that the setup and test environment requirements detailed in [Section 7.1](#) have been performed.

1. Play back the DCP *DCI HDR White Steps*.
2. For each of the ten steps of Table 3 at [DCI-HDR], measure the output luminance with a **Spectroradiometer** and verify that the result is within the tolerance specified in [Table 7.5](#).
3. Play back the DCP *DCI HDR Gray Steps*.
4. For each of the ten steps of Table 4 at [DCI-HDR], measure the output luminance with a **Spectroradiometer** and verify that the result is within the tolerance specified in [Table 7.5](#).

Any verification that fails is cause to fail this test.

Table 7.5.28(a) HDR black-to-white gray step-scale test pattern nominal luminance values

Step Number	Nominal Luminance (cd/m ²)	Tolerance	
		Projector	Direct View Display
1	0.50	±5%	±12%
2	1.00	±5%	±12%
3	2.00	±3%	±6%
4	5.00	±3%	±6%
5	9.99	±3%	±6%
6	20.00	±3%	±6%
7	50.01	±3%	±6%
8	100.10	±3%	±6%
9	200.21	±3%	±6%
10	299.64	±3%	±6%

Table 7.5.28(b) HDR black-to-dark gray step-scale test pattern nominal luminance values

Step Number	Nominal Luminance (cd/m ²)	Tolerance	
		Projector	Direct View Display
1	0.0050	±20%	±20%
2	0.0075	±20%	±20%
3	0.0100	±20%	±20%
4	0.0151	±20%	±20%
5	0.0202	±5%	±12%
6	0.0352	±5%	±12%
7	0.0501	±5%	±12%
8	0.0752	±5%	±12%
9	0.0998	±5%	±12%
10	0.1997	±5%	±12%

Supporting Materials

Reference Documents	[DCI-HDR] [DV-ADD]
Test Equipment	Spectroradiometer
Test Materials	<i>DCI HDR Gray Steps</i> <i>DCI HDR White Steps</i> <i>HDR Sequential Contrast and Uniformity Sequence</i>

Consolidated Test Sequences

Sequence	Type	Measured Data
26.2. HDR Direct View Display Test Sequence	Pass/Fail	—
28.2. HDR Projector Test Sequence	Pass/Fail	—

7.5.29. SDR Minimum Active Black Level

Objective

Verify that the Imaging Device achieves the required minimum luminance when presented with an SDR full black signal.

Procedures

1. Ensure that the Imaging Device setup and test environment requirements detailed in 7.1. Test Environment for Image Measurements have been performed.
2. For each of the following test materials, display the material and measure the luminance according to the *full-screen black* procedure at [ICDM IDMS]:

2K Full SDR Black

- o *2K Scope SDR Black*
- o *2K Flat SDR Black*
- o *4K Full SDR Black*
- o *4K Scope SDR Black*
- o *4K Flat SDR Black*

3. Verify that the measured luminance is within the range:

- o [0.01, 0.024] cd/m², if the Test Subject is a Direct View Display; or
- o [0.01, 0.032] cd/m², if the Test Subject is a Projector.

Any verification that fails is cause to fail this test.

Supporting Materials

Reference Documents	[ICDM IDMS] SMPTE-431-2
Test Equipment	Spectroradiometer
Test Materials	<i>2K Full SDR Black</i> <i>2K Scope SDR Black</i> <i>2K Flat SDR Black</i> <i>4K Full SDR Black</i> <i>4K Scope SDR Black</i> <i>4K Flat SDR Black</i>

Consolidated Test Sequences

Sequence	Type	Measured Data
24.2. SDR Projector Test Sequence	Pass/Fail	—
26.2. HDR Direct View Display Test Sequence	Pass/Fail	—
27.2. SDR Direct View Display Test Sequence	Pass/Fail	—
28.2. HDR Projector Test Sequence	Pass/Fail	—

7.5.30. Direct View Display Test Environment

Objective

Record information about the test environment in which the reported Direct View Display measurements were made.

Procedures

1. Setup the test environment as specified in 7.1. Test Environment for Image Measurements.
2. Record the height and width of the Direct View Display in units of meters.
3. Record the number of modules that comprise the Direct View Display, in both the horizontal and vertical directions.
4. With the Direct View Display switched off, record, in units of cd/m^2 , the luminance at the center of the Direct View Display.

Failure to record any data is cause to fail this test.

Supporting Materials

Test Equipment	Spectroradiometer
----------------	-------------------

Consolidated Test Sequences

Sequence	Type	Measured Data
26.2. HDR Direct View Display Test Sequence	Pass/Fail	All data recorded per the test procedure
27.2. SDR Direct View Display Test Sequence	Pass/Fail	All data recorded per the test procedure

7.5.31. Automatic SDR/HDR mode switching

Objective

Verify that the projection system automatically switches between SDR and HDR presentation.

Procedures

1. Setup the test environment as specified in 7.1. Test Environment for Image Measurements.
2. Build a show playlist out of the following compositions, in the order listed and without any automation or configuration related to HDR and SDR presentation:
 - a. *SDR Detection*
 - b. *HDR Detection*
 - c. *SDR Detection*
3. Play back the show, and measure and record the luminance for each of the *SDR dark*, *SDR light*, *HDR dark* and *HDR light* patches according to the *full-screen arbitrary color (R, G, B)* procedure at [ICDM IDMS].
4. Build a show playlist out of the following compositions, in the order listed and without any automation or configuration related to HDR and SDR presentation:

a. HDR Detection

b. SDR Detection

c. HDR Detection

5. Play back the show, and measure and record the luminance for each of the *SDR dark*, *SDR light*, *HDR dark* and *HDR light* patches according to the *full-screen arbitrary color (R, G, B)* procedure at [ICDM IDMS].

6. Verify that, in all cases, the measured luminance for the patches are within the allowable luminance ranges specified at [Table 7.5](#).

Any verification that fails is cause to fail this test.

Table 7.5.31 Target SDR and HDR luminances

Patch	Allowable luminance range (cd/m ²)	
	Projector	Direct View Display
SDR dark	[0.01, 0.032]	[0.01, 0.024]
SDR light	15.20 ± 0.46	
HDR dark	0.005 ± 0.001	
HDR light	299.6 ± 18	299.6 ± 9

Supporting Materials

Reference Documents	[DCI-HDR]
Test Materials	<i>SDR Detection</i> <i>HDR Detection</i>

Consolidated Test Sequences

Sequence	Type	Measured Data
26.2. HDR Direct View Display Test Sequence	Pass/Fail	—
28.2. HDR Projector Test Sequence	Pass/Fail	—

7.5.32. HDR Inactive Black Level (Direct View Display)

Objective

1. Verify that pixels outside the decoded image area are not emitting any light.
2. Verify that pixels outside the area specified by the *MainPictureActiveArea* item of the CPL metadata are not emitting any light.

Procedures

1. Ensure that the Imaging Device setup and test environment requirements detailed in 7.1. Test Environment for Image Measurements have been performed.

2. For each of the following test materials, display the material and verify by visual inspection that: (a) registration marks are visible and (b) pixels outside the rectangular area delineated by the registration marks are not emitting any light:
 - o *2K Full HDR Black with Marks*
 - o *2K Scope HDR Black with Marks*
 - o *2K Flat HDR Black with Marks*
 - o *4K Full HDR Black with Marks*
 - o *4K Scope HDR Black with Marks*
 - o *4K Flat HDR Black with Marks*

Any verification that fails is cause to fail this test.

3. For each of the following test materials, display the material and verify by visual inspection that: (a) registration marks are visible and (b) no red pixels are visible:
 - o *2K Full HDR Black with Active Area*
 - o *2K Scope HDR Black with Active Area*
 - o *2K Flat HDR Black with Active Area*
 - o *4K Full HDR Black with Active Area*
 - o *4K Scope HDR Black with Active Area*
 - o *4K Flat HDR Black with Active Area*

Any verification that fails is cause to fail this test.

Supporting Materials

Reference Documents	[DV-ADD] [DCI-HDR]
Test Materials	<i>2K Full HDR Black with Marks</i> <i>2K Scope HDR Black with Marks</i> <i>2K Flat HDR Black with Marks</i>

4K Scope HDR Black with Marks
 4K Flat HDR Black with Marks
 2K Full HDR Black with Active Area
 2K Scope HDR Black with Active Area
 2K Flat HDR Black with Active Area
 4K Full HDR Black with Active Area
 4K Scope HDR Black with Active Area
 4K Flat HDR Black with Active Area

Consolidated Test Sequences

Sequence	Type	Measured Data
26.2. HDR Direct View Display Test Sequence	Pass/Fail	—

7.5.33. Image Frame Rates

Objective

Verify that the Imaging Device displays every frame at all required frame rates.

Procedures

1. Ensure that the Imaging Device setup and test environment requirements detailed in [7.1. Test Environment for Image Measurements](#) have been performed.
2. Play each of the following compositions in turn:
 - a. If the Test Subject is an SDR Projector:
 - 2K 2D 24 FPS Test
 - 2K 2D 48 FPS Test
 - 4K 2D 24 FPS Test
 - b. For all other Test Subjects:
 - 2K 2D 24 FPS Test
 - 2K 2D 48 FPS Test
 - 2K 2D 60 FPS Test
 - 2K 2D 96 FPS Test
 - 2K 2D 120 FPS Test
 - 4K 2D 24 FPS Test

- 4K 2D 48 FPS Test
- 4K 2D 60 FPS Test

3. For each of the compositions played above, and as illustrated at [Figure 7.5](#), verify that:

- the movement of the pendulum is smooth and uninterrupted;
- the timecode is displayed at the bottom of the frame matches the one displayed at the top right of the frame;
- for 4K compositions, the word 4K is displayed at the center of the image;
- the words "left" and "right" are heard through the **Sound System** as the pendulum reaches the extreme left and right of its trajectory, respectively; and
- the following words appear: 1, 2, 3, 4, 5, even and odd.

Any verification that fails is cause to fail this test.

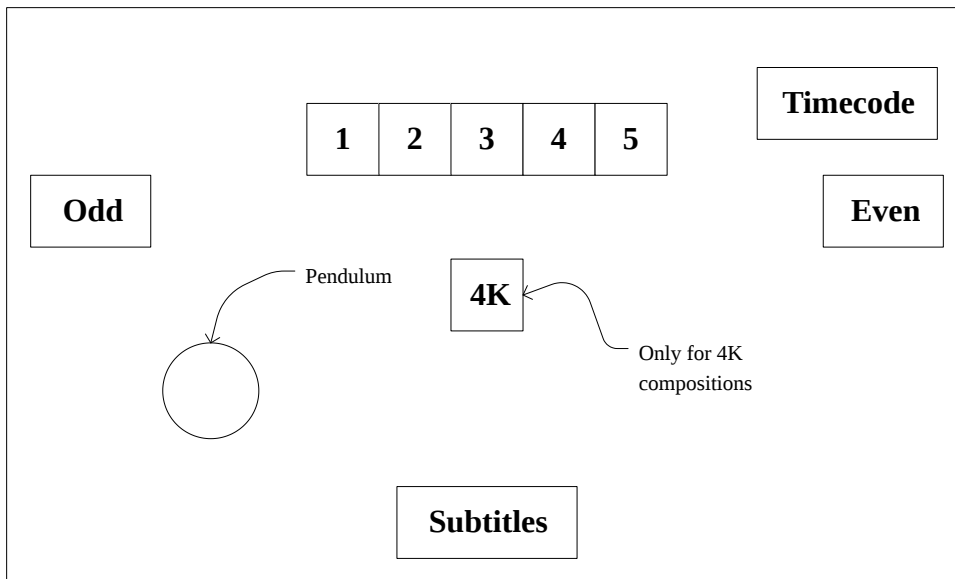

Figure 7.5.33. Location of the elements displayed when testing image frame rates (not to scale)

Supporting Materials

Reference Documents	[DV-ADD] DCI-DCSS, 3.2.1
Test Equipment	Sound System
Test Materials	2K 2D 24 FPS Test 2K 2D 48 FPS Test 2K 2D 60 FPS Test

2K 2D 96 FPS Test
 2K 2D 120 FPS Test
 4K 2D 24 FPS Test
 4K 2D 48 FPS Test
 4K 2D 60 FPS Test

Consolidated Test Sequences

Sequence	Type	Measured Data
24.2. SDR Projector Test Sequence	Pass/Fail	—
26.2. HDR Direct View Display Test Sequence	Pass/Fail	—
27.2. SDR Direct View Display Test Sequence	Pass/Fail	—
28.2. HDR Projector Test Sequence	Pass/Fail	—

7.5.34. Stereoscopic Image Frame Rates

Objective

Verify that, for stereoscopic presentations, the Imaging Device displays every frame at all required frame rates.

Procedures

This test procedure only applies to Test Subject that support stereoscopic presentations.

1. Ensure that the Imaging Device setup and test environment requirements detailed in [7.1. Test Environment for Image Measurements](#) have been performed.
2. Play each of the following compositions in turn:
 - o 2K Stereoscopic 24 FPS Test
 - o 2K Stereoscopic 48 FPS Test
 - o 2K Stereoscopic 60 FPS Test
3. For each of the compositions played above, and as illustrated at [Figure 7.5](#), verify that:
 - o the movement of the pendulum is smooth and uninterrupted;
 - o the pendulum pops out of the screen;
 - o the timecode is displayed at the bottom of the frame matches the one displayed at the top right of the frame;
 - o the words "left" and "right" are heard through the **Sound System** as the pendulum reaches the extreme left and right of its trajectory, respectively;

- o the words `left` and `right` appear only in the left and right eye, respectively; and
- o the following words appear: 1, 2, 3, 4, 5, even and odd.

Any verification that fails is cause to fail this test.

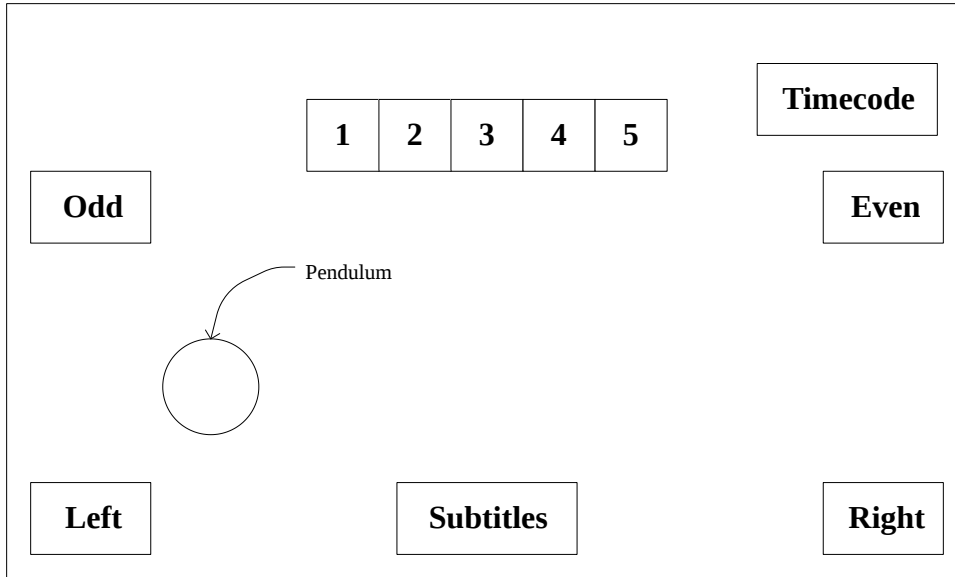

Figure 7.5.34. Location of the elements displayed when testing stereoscopic image frame rates (not to scale)

Supporting Materials

Reference Documents	[DV-ADD] DCI-DCSS, 10.2.2
Test Equipment	Sound System
Test Materials	<i>2K Stereoscopic 24 FPS Test</i> <i>2K Stereoscopic 48 FPS Test</i> <i>2K Stereoscopic 60 FPS Test</i>

Consolidated Test Sequences

Sequence	Type	Measured Data
26.2. HDR Direct View Display Test Sequence	Pass/Fail	—
27.2. SDR Direct View Display Test Sequence	Pass/Fail	—

7.5.35. HDR Contouring

Objective

Confirm the Imaging Device exhibits no visible contouring when presenting an HDR composition.

Procedures

1. Ensure that the Imaging Device setup and test environment requirements detailed in 7.1. Test Environment for Image Measurements have been performed.
2. Play back *HDR Dark Gray Scale* and measure, using a **Spectroradiometer**, the luminance L_i at the center of the screen of each full-screen gray patch.
3. Calculate the set of second approximate derivatives from the set of measurements $\{L_i\}$ according to the *slope monotonicity of gray scale* procedure at [ICDM IDMS].
4. Verify that all the second approximate derivatives are greater than 0.

Any verification that fails is cause to fail this test.

Supporting Materials

Reference Documents	DCI-DCSS, 8.3.3 [SMPTE-431-2] [DCI-HDR]
Test Materials	<i>HDR Dark Gray Scale</i>

Consolidated Test Sequences

Sequence	Type	Measured Data
26.2. HDR Direct View Display Test Sequence	Pass/Fail	—
28.2. HDR Projector Test Sequence	Pass/Fail	—

Chapter 8. Screen Management System

A Screen Management System (SMS) (or Theater Management System (TMS)) is responsible for providing the operator's interface for ingest, scheduling, reporting, etc. In this document the term SMS will be used exclusively, although the same test procedures can apply to a TMS that is able to directly manage a suite of equipment for a screen.

The SMS is not hosted on secure hardware (*i.e.*, it is not required to be within an SPB).

8.1. Ingest and Storage

8.1.1. Storage System Ingest Interface

Objective

Verify that the system provides an interface to the storage system, for DCP ingest, that is Ethernet, 1Gb/s or better, over copper (1000Base-T) or fiber (1000Base-FX), as described in [IEEE-802-3], running the TCP/IP protocol.

Procedures

1. Use a computer with the appropriate interface cards, *e.g.*, 1000Base-T copper Ethernet and network analysis tools such as Wireshark installed, to tap the ingest interface.

2. Ingest *DCI 2K StEM Test Sequence (Encrypted)* and verify that the packets can be read by the computer that runs the network analysis tools. Failure to observe the packets contained in the DCP is cause to fail this test.
3. Verify that the data packets read are valid TCP/IP data packets. Use of any other protocol to ingest the DCP is cause to fail this test.

Supporting Materials

Reference Documents	DCI-DCSS, 6.2.3 IEEE-802-3
Test Equipment	Network Analyzer
Test Materials	<i>DCI 2K StEM Test Sequence (Encrypted)</i>

Consolidated Test Sequences

Sequence	Type	Measured Data
----------	------	---------------

8.1.2. Storage System Capacity

Objective

Verify that the storage system available to the SMS has a capacity of at least 1TByte of content.

Procedures

Verify that the storage system has the capacity to hold at least 1TByte of content. This can be done in three ways:

1. Verify by using the specification of the manufacturer.
2. Examine the capacity of the file system representing the storage system, and verify that there is enough available storage to hold 1 TByte of content data. Use appropriate file system tools to perform this task.
3. Measure the storage capacity by copying 1TByte of content to the storage and verifying that no content has been purged by playing back all content.

If the capacity of the storage system is less than 1TByte, this is cause to fail this test.

Supporting Materials

Reference Documents	DCI-DCSS, 7.2.3.11
----------------------------	--------------------

Consolidated Test Sequences

Sequence	Type	Measured Data
----------	------	---------------

8.1.3. Storage System Redundancy

Objective

Verify that the storage system available to the SMS provides redundancy in the case of a drive failure.

Procedures

Verify the existence and functionality of an appropriate RAID configuration by performing the following:

1. Ingest the composition *DCI 2K StEM (Encrypted)* i.e., load it into the storage system.
2. Power down the system.
3. Disconnect one drive of the RAID configuration.
4. Re-power the system.
5. Set up and play a show that contains the composition *DCI 2K StEM (Encrypted)*, keyed with *KDM for 2K StEM (Encrypted)* and verify that playback is successful, i.e., playback can be started, is not interrupted and does not show any picture or sound artifacts. Unsuccessful playback is cause to fail this test.
6. Power down the system and reconnect the drive that was disconnected in step 3.
7. Repower the system and perform any necessary manufacturer-specified procedures to restore the RAID configuration to normal.
8. Repeat steps 2 through 7 for all other drives contained in the storage system.

Supporting Materials

Reference Documents	DCI-DCSS, 7.5.3.2
Test Materials	<i>DCI 2K StEM (Encrypted)</i> <i>KDM for 2K StEM (Encrypted)</i>

Consolidated Test Sequences

Sequence	Type	Measured Data
15.2. Integrated IMB Test Sequence	Pass/Fail	—
21.2. Integrated IMBO Test Sequence	Pass/Fail	—

8.1.4. Storage System Performance

Objective

Verify that the storage system available to the SMS is able to sustain a minimum peak data rate of 307 MBit/sec to allow for uninterrupted digital cinema playback.

Procedures

1. Setup and play the composition *2K DCI Maximum Bitrate Composition (Encrypted)*, keyed with *KDM for 2K Maximum Bitrate Composition (Encrypted)*. This composition starts with a count to check synchronization between picture and sound. 10 minutes of an image with minimal compression and 16 audio channels (each 24 bit per sample, 96 kHz) follows, then a second synchronization count. The content between the synchronization counts will require the maximum allowable data rate for successful reproduction.
2. Verify that playback is successful, *i.e.*, playback can be started, is not interrupted and does not show any picture or sound artifacts. Unsuccessful playback is cause to fail this test.
3. Extract the logs from the Test Subject and examine the associated `FrameSequencePlayed` and `PlayoutComplete` events recorded during the playback for complete and successful reproduction. Any exceptions or missing `FrameSequencePlayed` or `PlayoutComplete` events are cause to fail this test.

Supporting Materials

Reference Documents	DCI-DCSS, 7.5.3.3, 7.5.3.4, 7.5.3.6
Test Materials	<i>2K DCI Maximum Bitrate Composition (Encrypted)</i> <i>KDM for 2K Maximum Bitrate Composition (Encrypted)</i>

Consolidated Test Sequences

Sequence	Type	Measured Data
15.2. Integrated IMB Test Sequence	Pass/Fail	—
21.2. Integrated IMBO Test Sequence	Pass/Fail	—

8.1.5. Deleted Section

The section "Storage System Redundancy (OBAE)" was deleted. The section number is maintained here to preserve the numbering of subsequent sections.

8.1.6. Storage System Performance (OBAE)

Objective

Verify that the storage system available to the OBAE-capable SMS allows uninterrupted playback of maximum bitrate content.

Procedures

1. Setup and play the composition *2K DCI Maximum Bitrate Composition (OBAE) (Encrypted)*, keyed with *KDM for 2K DCI Maximum Bitrate Composition (OBAE) (Encrypted)*. This composition requires the maximum allowable data rate for successful reproduction.
2. Verify that playback is successful, *i.e.*, playback can be started, is not interrupted and does not show any picture or sound artifacts. Unsuccessful playback is cause to fail this test.

3. Extract the logs from the Test Subject and examine the associated `FrameSequencePlayed` and `PlayoutComplete` events recorded during the playback for complete and successful reproduction. Any exceptions or missing `FrameSequencePlayed` or `PlayoutComplete` events are cause to fail this test.

Supporting Materials

Reference Documents	DCI-DCSS, 7.5.3.3, 7.5.3.4, 7.5.3.6
Test Materials	2K DCI Maximum Bitrate Composition (OBAE) (Encrypted) KDM for 2K DCI Maximum Bitrate Composition (OBAE) (Encrypted)

Consolidated Test Sequences

Sequence	Type	Measured Data
20.2. OMB Test Sequence	Pass/Fail	—
21.2. Integrated IMBO Test Sequence	Pass/Fail	—

8.2. Screen Management System

8.2.1. Deleted Section

The section "Screen Management System" was deleted. The section number is maintained here to preserve the numbering of subsequent sections.

8.2.2. Show Playlist Creation

Objective

- Verify that the SMS provides the necessary functions for managing Composition Play Lists (CPLs) and for assembling them into shows (SPL creation).
- Verify that the SMS allows only authorized persons to build a Show Playlist (SPL).

Procedures

1. Ingest the composition *DCI 2K StEM* into the system.
2. Using the system, locate the composition *DCI 2K StEM*.
3. Create a new Show Play List (SPL) and add *DCI 2K StEM* twice to the show. The two instances of *DCI 2K StEM* are herein referred to as *DCI 2K StEM X* and *DCI 2K StEM Y*.
4. Ingest the composition *DCI 2K StEM (Encrypted)* and the KDM *KDM for 2K StEM (Encrypted)* into the system.
5. Using the system, locate the composition *DCI 2K StEM (Encrypted)*.

6. Append the composition *DCI 2K StEM (Encrypted)* to the end of the show.
7. In the show, move the composition *DCI 2K StEM (Encrypted)* in between *DCI 2K StEM X* and *DCI 2K StEM Y*.
8. Ingest *DCI Black Spacer - 5 seconds* and insert it between each of the compositions in the show.
9. Start playback and verify that the presentation proceeds as expected and the inserted black frames and silence are presented correctly.
10. Attempt to delete each of the compositions *DCI 2K StEM*, *DCI 2K StEM (Encrypted)* and *DCI Black Spacer - 5 seconds* from system storage. The system is required to warn that the content is part of a current show and not allow deletion.
11. Wait until playback is completed.
12. Remove *DCI 2K StEM X* from the show.
13. Attempt to delete *DCI 2K StEM* from storage. It is expected that the SMS warns the user that this composition is part of an SPL.
14. Delete the show then delete *DCI 2K StEM* and *DCI 2K StEM (Encrypted)*. It is expected that this operation succeeds.
15. Verify that the aforementioned compositions have been removed.
16. Verify that the above functions for assembling content into an SPL are executable with an easy to use graphical user interface.

Supporting Materials

Reference Documents	DCI-DCSS, 7.2.3.5, 7.2.3.7, 7.3.4, 7.4.1.1, 7.4.1.2, 7.4.1.3, 7.4.1.4, 7.4.1.5, 7.4.1.6
Test Materials	<i>DCI 2K StEM</i> <i>DCI 2K StEM (Encrypted)</i> <i>KDM for 2K StEM (Encrypted)</i> <i>DCI Black Spacer - 5 seconds</i>

Consolidated Test Sequences

Sequence	Type	Measured Data
15.2. Integrated IMB Test Sequence	Data only	—
21.2. Integrated IMBO Test Sequence	Data only	—

8.2.3. Show Playlist Format

Objective

Verify that the SMS supports the required Show Playlist Format.

Procedures

1. Export the Show Playlist (SPL) to external media.
2. Use the software command **schema-check** to verify that the SPL exported in the above step is well formed XML. XML format errors are cause to fail this test. An example is shown below.

```
$ schema-check <input-file>  
schema validation successful
```

Supporting Materials

Reference Documents	DCI-DCSS, 7.3, 7.4.1.6
Test Equipment	schema-check

Consolidated Test Sequences

Sequence	Type	Measured Data
15.2. Integrated IMB Test Sequence	Pass/Fail	—
21.2. Integrated IMBO Test Sequence	Pass/Fail	—

8.2.4. Deleted Section

The section "KDM Validity Checks" was deleted. The section number is maintained here to preserve the numbering of subsequent sections.

8.2.5. Automation Control and Interfaces

Objective

Verify that the SMS supports theater automation interface via any one or more of:

- contact closures (general purpose I/O)
- serial data interface
- network (e.g., Ethernet)

Procedures

1. Configure an automation test setup that allows the Test Subject to signal an event using a visible state change (e.g. an L.E.D.), and allows the Test Subject to be signalled via external stimulus (e.g., an SPST switch).
2. Verify that the Test Subject can change the state of the event indicator at pre-determined times using the playlist. Failure to meet this requirement shall be cause to fail this test.

3. Verify that playback of a playlist on the Test Subject can be started by external stimulus. Failure to meet this requirement shall be cause to fail this test.

Supporting Materials

Reference Documents	DCI-DCSS, 7.3.4, 7.4.1.6, 7.4.1.7, 7.5.7.2
Test Equipment	GPIO Test Fixture
Test Materials	<i>DCI 2K StEM Test Sequence</i>

Consolidated Test Sequences

Sequence	Type	Measured Data
15.2. Integrated IMB Test Sequence	Pass/Fail	—
21.2. Integrated IMBO Test Sequence	Pass/Fail	—

8.2.6. Interrupt Free Playback

Objective

Verify that the system can play a sequence of CPLs (a Show Playlist) without noticeable interruptions such as unexpected pauses or visual or audible artifacts.

Procedures

To verify that playback is possible without any interruptions:

1. Assemble a show containing the compositions *4K DCI NIST Frame with silence*, *DCI 5.1 Channel Identification DCI 2K Sync test with Subtitles (Encrypted)* and *DCI 2K StEM (Encrypted)*, keyed with *KDM for DCI 2K Sync Test with Subtitles (Encrypted)* and *KDM for 2K StEM (Encrypted)*
2. Play back the show. Verify that playback succeeds and is completed without any image or sound distortions and without any interruption. Incomplete or interrupted playback or the presence of distortions or artifacts shall be cause to fail this test.

Supporting Materials

Reference Documents	DCI-DCSS, 7.4.1.8
Test Materials	<i>4K DCI NIST Frame with silence</i> <i>DCI 5.1 Channel Identification</i> <i>DCI 2K Sync test with Subtitles (Encrypted)</i> <i>DCI 2K StEM (Encrypted)</i> <i>KDM for DCI 2K Sync Test with Subtitles (Encrypted)</i> <i>KDM for 2K StEM (Encrypted)</i>

Consolidated Test Sequences

Sequence	Type	Measured Data
15.2. Integrated IMB Test Sequence	Pass/Fail	—
21.2. Integrated IMBO Test Sequence	Pass/Fail	—

8.2.7. Artifact Free Transition of Image Format

Objective

Verify artifact free transition between differing pixel array sizes.

Procedures

To verify that mode transitions do not cause any artifacts:

1. Assemble a Show that contains 3 repetitions of the following 2 compositions *DCI 2K Image with Frame Number Burn In (Flat)*, which contains two reels of 1.85:1 content, followed by *DCI 2K Image with Frame Number Burn In (Scope)*, which contains two reels of 2.39:1 content.
2. Start playback and observe the projected image. Transitions between reels and compositions are announced visually by means of a burned-in counter. Verify that for all transitions, no visible artifacts, e.g., rolling, flashes, distorted images etc, are visible, and that every frame is displayed correctly on each outgoing and incoming transition. If any visible artifact is present or any incoming or outgoing frame is not displayed, this is cause to fail the test. *Note: Use of a camera to shoot the display off screen to confirm display of all frames can be helpful in this test.*

Supporting Materials

Reference Documents	DCI-DCSS, 7.4.1.6
Test Materials	<i>DCI 2K Image with Frame Number Burn In (Flat)</i> <i>DCI 2K Image with Frame Number Burn In (Scope)</i>

Consolidated Test Sequences

Sequence	Type	Measured Data
15.2. Integrated IMB Test Sequence	Pass/Fail	—
15.4. Integrated IMB Confidence Sequence	Pass/Fail	—
21.2. Integrated IMBO Test Sequence	Pass/Fail	—
21.4. Integrated IMBO Confidence Sequence	Pass/Fail	—

8.2.8. Restarting Playback

Objective

Verify that power failures cause the system to enter a stable stop/idle condition and that the system provides the ability to restart playback at a point prior to a power interruption.

Procedures

1. Load *DCI 2K Image with Frame Number Burn In (Encrypted)* and *KDM for DCI 2K Image with Frame Number Burn In (Encrypted)*, then assemble and start a show.
2. Interrupt the presentation by interrupting the Test Subject's power supply. If possible, a projector power supply should not be interrupted as this may cause overheating and damage the projector.
3. Re-establish power and verify that the system enters a stable stop/idle state. Failure to meet this requirement is cause to fail this test.
4. Verify that the system notifies the user that the last playback was abnormally interrupted, and offers the possibility of restarting the show. Failure to meet this requirement is cause to fail this test.
5. Attempt to restart the presentation at a point prior to the power interruption and verify that the restart was successful. Failure to meet this requirement is cause to fail this test.

Supporting Materials

Reference Documents	DCI-DCSS, 7.2.3.13, 7.4.1.2, 7.4.1.8
Test Materials	<i>KDM for DCI 2K Image with Frame Number Burn In (Encrypted)</i> <i>DCI 2K Image with Frame Number Burn In (Encrypted)</i>

Consolidated Test Sequences

Sequence	Type	Measured Data
15.2. Integrated IMB Test Sequence	Pass/Fail	—
21.2. Integrated IMBO Test Sequence	Pass/Fail	—

8.2.9. SMS User Accounts

Objective

Verify that the SMS supports multiple levels of user accounts.

Procedures

1. Study the user manual to discover factory-created account names and passwords.
2. If required by the system, create the necessary operating accounts.
3. Return the system to the "logged out" state.
4. For each account, log on to the system using the account information and note the privileges available to the account user (*e.g.*, run show, load content, create account, etc.). Failure of the system to provide privilege separation using distinct user accounts is cause to fail this test.

Supporting Materials

Reference Documents	DCI-DCSS, 7.4.1.3
----------------------------	-------------------

Consolidated Test Sequences

Sequence	Type	Measured Data
15.2. Integrated IMB Test Sequence	Pass/Fail	Record the available operator roles (names) and whether locally-defined accounts can be created.
21.2. Integrated IMBO Test Sequence	Pass/Fail	Record the available operator roles (names) and whether locally-defined accounts can be created.

8.2.10. SMS Operator Identification

Objective

Verify that the security system requires the SMS and SMS operator to be identified to the Security Manager.

Procedures

1. List all the methods available to the Test Subject that can cause playback of a composition or show. This could include any preset or created user accounts/logins to the SMS/TMS, direct command, e.g., by front panel controls or automation inputs and events initiated by an automatic scheduler. Manufacturer-supplied documentation, including manuals, may be consulted to assist with this step.
2. For each of the cases from the list created in Step 1, cause the composition *DCI 2K StEM (Encrypted)*, or a show that contains it, to play back. Record the time of day at the end of each playback.
3. Retrieve the audit logs from the system.
4. By using the time values recorded in Step 2, for each of the cases from the list created in Step 1:
 - a. Locate the corresponding `FrameSequencePlayed` playout events.
 - b. Verify that there is a `FrameSequencePlayed` event for both audio and image and that they each contain a parameter named `AuthId` with a value that is not absent.
 - c. Record each `AuthId` value. Any missing `AuthId` parameter or any `AuthId` parameter that has a value that is unpopulated is cause to fail this test.

Supporting Materials

Reference Documents	DCI-DCSS, 9.4.1.1
Test Materials	<i>DCI 2K StEM (Encrypted)</i> <i>KDM for 2K StEM (Encrypted)</i>

Consolidated Test Sequences

Sequence	Type	Measured Data
----------	------	---------------

15.2. Integrated IMB Test Sequence	Pass/Fail	—
21.2. Integrated IMBO Test Sequence	Pass/Fail	—

8.2.11. SMS Identity and Certificate

Objective

- Verify that the SMS carries a [SMPTE-430-2] compliant digital certificate that identifies the SMS entity.
- Verify that the SMS certificate indicates either the SMS role, or the TMS role, unless the SMS is contained within an SPB meeting the protection requirements for any other designated roles.

Procedures

1. Obtain the SMS certificate (and chain if available):
 - If the SMS communicates with the SM via a network accessible to test equipment, use network analysis tools (e.g., Wireshark) to monitor the packets exchanged between the SMS and SM and extract the leaf certificate and, if present, the associated signing certificate(s). If signing certificates are not present, obtain them from the manufacturer.
 - If network monitoring is not possible, obtain the complete certificate chain from the manufacturer.
2. Extract the Subject Common Name field from the leaf certificate collected in step 1. Failure for the Common Name to include either the SMS role, or the TMS role, is cause to fail the test.
3. Verify that the Subject Common Name field of the leaf certificate collected in step 1 contains the serial number of the Test Subject. Additional identifying information may be present. Failure of this verification is cause to fail the test.
4. Verify that information identifying the make and model of the Test Subject is carried in the Subject field of the certificate collected in step 1. Additional identifying information may be present. Failure of this verification is cause to fail the test.
5. Verify that either the make, model and serial number of the Test Subject, or information that is unambiguously traceable by the manufacturer to the Subject field from the leaf certificate obtained in step 1, is clearly placed on the exterior of the device containing the Test Subject. Failure of this verification is cause to fail the test.

Supporting Materials

Reference Documents	DCI-DCSS, 9.4.2.5, 9.5.1
Test Equipment	Network Analyzer openssl

Consolidated Test Sequences

Sequence	Type	Measured Data
----------	------	---------------

15.2. Integrated IMB Test Sequence	Pass/Fail	—
15.4. Integrated IMB Confidence Sequence	Pass/Fail	—
21.2. Integrated IMBO Test Sequence	Pass/Fail	—
21.4. Integrated IMBO Confidence Sequence	Pass/Fail	—

8.2.12. Content Keys and TDL check

Objective

1. Verify that the SMS, working with the security infrastructure, checks that, prior to initiating playback of a Show Playlist (scheduled exhibition), (i) all content keys required for the playback of the Show Playlist are available and valid, and (ii) playback is disallowed when the KDM's TDL is empty, and allowed when the KDM's TDL is Assume Trust.
2. Verify that the SMS does this check for every composition individually.

Procedures

With the test materials specified below, perform the following procedures:

1. Try to assemble and play a show using *DCI 2K StEM (Encrypted)* without providing a KDM. If playback begins this is cause to fail this test.
2. Try to assemble and play a show using *DCI 2K Sync Test (Encrypted)*, keyed with *KDM for DCI 2K Sync Test (Encrypted)* and *DCI 2K StEM (Encrypted)*, keyed with *KDM with incorrect message digest* in that order. The *KDM with incorrect message digest* is invalid (wrong signature/hash error). If playback begins this is cause to fail this test.
3. Try to assemble and play a show using *DCI 2K Sync Test (Encrypted)*, keyed with *KDM for DCI 2K Sync Test (Encrypted)* and *DCI 2K StEM (Encrypted)*, keyed with *KDM that has expired* which contains an expired time window. If playback begins this is cause to fail this test.
4. Try to assemble and play a show using *DCI 2K Sync Test (Encrypted)*, keyed with *KDM for DCI 2K Sync Test (Encrypted)* and *DCI 2K StEM (Encrypted)*, keyed with *KDM with future validity period* which contains a time window in the future. If playback begins this is cause to fail this test.
5. Try to assemble and play a show using *DCI 2K Sync Test (Encrypted)*, keyed with *KDM for DCI 2K Sync Test (Encrypted)* and *DCI 2K StEM (Encrypted)*, keyed with *KDM with invalid XML* which contains an XML malformation. If playback begins this is cause to fail this test.
6. Try to assemble and play a show using *DCI 2K Sync Test (Encrypted)*, with *KDM for DCI 2K Sync Test (Encrypted)* and *DCI 2K StEM (Encrypted)*, keyed with *KDM with empty TDL*, which is a KDM that does not list any trusted devices in its TDL. If playback begins this is cause to fail this test.
7. Try to assemble and play a show using *DCI 2K Sync Test (Encrypted)*, keyed with *KDM for DCI 2K Sync Test (Encrypted)* and *DCI 2K StEM (Encrypted)*, keyed with *KDM with Assume Trust TDL Entry for 2K StEM (Encrypted)*, which is a KDM that carries only the "assume trust" empty-string thumbprint. Attempt to play the composition and record the result. If playback does not begin this is cause to fail this test.

Supporting Materials

Reference Documents	DCI-DCSS, 9.4.3.2 SMPTE-430-1
Test Materials	<i>DCI 2K StEM (Encrypted)</i> <i>DCI 2K Sync Test (Encrypted)</i> <i>KDM for DCI 2K Sync Test (Encrypted)</i> <i>KDM with incorrect message digest</i> <i>KDM that has expired</i> <i>KDM with future validity period</i> <i>KDM with invalid XML</i> <i>KDM with empty TDL</i> <i>KDM with Assume Trust TDL Entry for 2K StEM (Encrypted)</i>

Consolidated Test Sequences

Sequence	Type	Measured Data
15.2. Integrated IMB Test Sequence	Pass/Fail	—
15.4. Integrated IMB Confidence Sequence	Pass/Fail	—
21.2. Integrated IMBO Test Sequence	Pass/Fail	—
21.4. Integrated IMBO Confidence Sequence	Pass/Fail	—

8.2.13. Content Keys and TDL check (OBAE)

Objective

1. Verify that the SMS checks that, prior to initiating playback of a Show Playlist that contains OBAE content, (i) all content keys required for the playback of the Show Playlist are available and valid, and (ii) playback is disallowed when the KDM's TDL is empty, and allowed when the KDM's TDL is Assume Trust.
2. Verify that the SMS does this check for every composition individually.

Note:

Two instances of each KDM listed below are needed if the Test Subject is an OMB: one instance of each KDM for the IMB and one instance of each KDM for the OMB.

Procedures

With the test materials specified below, perform the following procedures:

1. Try to assemble and play a show using *DCI 2K StEM (OBAE) (Encrypted)* without providing a KDM. If playback begins this is cause to fail this test.
2. Try to assemble and play a show using *DCI 2K Sync Test (OBAE) (Encrypted)*, keyed with *KDM for DCI 2K Sync Test (OBAE) (Encrypted)* and *DCI 2K StEM (OBAE) (Encrypted)*, keyed with *KDM with incorrect message digest (OBAE)* in that order. If playback begins this is cause to fail this test.

3. Try to assemble and play a show using *DCI 2K Sync Test (OBAE) (Encrypted)*, keyed with *KDM for DCI 2K Sync Test (OBAE) (Encrypted)* and *DCI 2K StEM (OBAE) (Encrypted)*, keyed with *KDM that has expired (OBAE)*. If playback begins this is cause to fail this test.
4. Try to assemble and play a show using *DCI 2K Sync Test (OBAE) (Encrypted)*, keyed with *KDM for DCI 2K Sync Test (OBAE) (Encrypted)* and *DCI 2K StEM (OBAE) (Encrypted)*, keyed with *KDM with future validity period (OBAE)*. If playback begins this is cause to fail this test.
5. Try to assemble and play a show using *DCI 2K Sync Test (OBAE) (Encrypted)*, keyed with *KDM for DCI 2K Sync Test (OBAE) (Encrypted)* and *DCI 2K StEM (OBAE) (Encrypted)*, keyed with *KDM with invalid XML (OBAE)*. If playback begins this is cause to fail this test.
6. Try to assemble and play a show using *DCI 2K Sync Test (OBAE) (Encrypted)*, keyed with *KDM for DCI 2K Sync Test (OBAE) (Encrypted)* and *DCI 2K StEM (OBAE) (Encrypted)*, keyed with *KDM with empty TDL (OBAE)*. If playback begins this is cause to fail this test.
7. Try to assemble and play a show using *DCI 2K Sync Test (OBAE) (Encrypted)*, keyed with *KDM for DCI 2K Sync Test (OBAE) (Encrypted)* and *DCI 2K StEM (OBAE) (Encrypted)*, keyed with *KDM with Assume Trust TDL Entry (OBAE)*. If playback does not begin this is cause to fail this test.

Supporting Materials

Reference Documents	DCI-DCSS, 9.4.3.2 SMPTE-430-1
Test Materials	<i>DCI 2K StEM (OBAE) (Encrypted)</i> <i>DCI 2K Sync Test (OBAE) (Encrypted)</i> <i>KDM for DCI 2K Sync Test (OBAE) (Encrypted)</i> <i>KDM with incorrect message digest (OBAE)</i> <i>KDM that has expired (OBAE)</i> <i>KDM with future validity period (OBAE)</i> <i>KDM with invalid XML (OBAE)</i> <i>KDM with empty TDL (OBAE)</i> <i>KDM with Assume Trust TDL Entry (OBAE)</i>

Consolidated Test Sequences

Sequence	Type	Measured Data
20.2. OMB Test Sequence	Pass/Fail	—
21.2. Integrated IMBO Test Sequence	Pass/Fail	—
20.4. OMB Confidence Sequence	Pass/Fail	—
21.4. Integrated IMBO Confidence Sequence	Pass/Fail	—

8.2.14. KDM Content Keys Check

Objective

Verify that the SMS checks that, prior to initiating playback of a Show Playlist, content keys carried in the KDM associated with a CPL included in the Show Playlist match exactly those content keys used by the CPL.

Procedures

For each of the rows of [Table 8.2](#), create a Show Playlist with the *Composition* and attempt to play it using the *Malformed KDM*. If playback begins this is cause to fail this test.

Table 8.2.14. List of Compositions and associated KDMs with mismatched content keys

Composition	Malformed KDM
sync_test_with_subs_ct.cpl.xml	m0100_missing_key_pict.kdm.xml
sync_test_with_subs_ct.cpl.xml	m0102_missing_key_snd.kdm.xml
sync_test_with_subs_ct.cpl.xml	m0104_missing_key_sub.kdm.xml
2K_sync_test_with_subs_obae_ct.cpl.xml	m0106_missing_key_pict_obae.kdm.xml
2K_sync_test_with_subs_obae_ct.cpl.xml	m0108_missing_key_snd_obae.kdm.xml
2K_sync_test_with_subs_obae_ct.cpl.xml	m0110_missing_key_sub_obae.kdm.xml
2K_sync_test_with_subs_obae_ct.cpl.xml	m0112_missing_key_obae_obae.kdm.xml

Supporting Materials

Reference Documents	DCI-DCSS, 9.4.3.5, 9.4.3.6.4 SMPTE-430-1
Test Equipment	Accurate Real-Time Clock Text Editor
Test Materials	<i>DCI 2K Sync test with Subtitles (Encrypted)</i> <i>DCI 2K Sync Test with subtitles (OBAE) (Encrypted)</i> <i>KDM for DCI 2K Sync test with Subtitles (Encrypted): missing picture essence key</i> <i>KDM for DCI 2K Sync test with Subtitles (Encrypted): missing sound essence key</i> <i>KDM for DCI 2K Sync test with Subtitles (Encrypted): missing subtitle essence key</i> <i>KDM for DCI 2K Sync Test with subtitles (OBAE) (Encrypted): missing picture essence key</i> <i>KDM for DCI 2K Sync Test with subtitles (OBAE) (Encrypted): missing sound essence key</i> <i>KDM for DCI 2K Sync Test with subtitles (OBAE) (Encrypted): missing picture subtitle key</i> <i>KDM for DCI 2K Sync Test with subtitles (OBAE) (Encrypted): missing OBAE key</i>

Consolidated Test Sequences

Sequence	Type	Measured Data
15.2. Integrated IMB Test Sequence	Pass/Fail	—
20.2. OMB Test Sequence	Pass/Fail	—

21.2. Integrated IMBO Test Sequence	Pass/Fail	—
-------------------------------------	-----------	---

8.2.15. Validity of SMS Certificates

Objective

Verify that the SMS certificates are valid.

Procedures

1. Obtain the SMS certificate (and chain if available):
 - o If the SMS communicates with the SM via a network accessible to test equipment, use network analysis tools (e.g., Wireshark) to monitor the packets exchanged between the SMS and SM and extract the leaf certificate and, if present, the associated signing certificate(s). If signing certificates are not present, obtain them from the manufacturer.
 - o If network monitoring is not possible, obtain the complete certificate chain from the manufacturer.
2. For each certificate, perform the following tests:
 - o 2.1.1. Basic Certificate Structure
 - o 2.1.2. SignatureAlgorithm Fields
 - o 2.1.3. SignatureValue Field
 - o 2.1.4. SerialNumber Field
 - o 2.1.5. SubjectPublicKeyInfo Field
 - o 2.1.6. Deleted Section
 - o 2.1.7. Validity Field
 - o 2.1.8. AuthorityKeyIdentifier Field
 - o 2.1.9. KeyUsage Field
 - o 2.1.10. Basic Constraints Field
 - o 2.1.11. Public Key Thumbprint
 - o 2.1.12. Organization Name Field
 - o 2.1.13. OrganizationUnitName Field
 - o 2.1.14. Entity Name and Roles Field

- o 2.1.15. Unrecognized Extensions
- o 2.1.16. Signature Validation

3. For the complete chain of signer certificates, perform 2.1.17. Certificate Chains

Failure of any of these above conditions is cause to fail this test.

Supporting Materials

Reference Documents	DCI-DCSS, 9.4.2.5, 9.5.1 SMPTE-430-2
Test Equipment	Network Analyzer openssl

Consolidated Test Sequences

Sequence	Type	Measured Data
15.2. Integrated IMB Test Sequence	Pass/Fail	—
15.4. Integrated IMB Confidence Sequence	Pass/Fail	—
21.2. Integrated IMBO Test Sequence	Pass/Fail	—
21.4. Integrated IMBO Confidence Sequence	Pass/Fail	—

8.2.16. Interrupt Free Playback (OBAE)

Objective

Verify that the OBAE-capable system can play a sequence of CPLs (a Show Playlist) without noticeable interruptions such as unexpected pauses or visual or audible artifacts.

Procedures

To verify that playback is possible without any interruptions:

1. Assemble a show containing the compositions:
 - o *DCI 2K Sync Test with subtitles (OBAE) (Encrypted) keyed with KDM for DCI 2K Sync Test with subtitles (OBAE) (Encrypted)*
 - o *OBAE Rendering Expectations (Clip)*
 - o *DCI 2K StEM (OBAE) (Encrypted) keyed with KDM for 2K StEM (Encrypted) (OBAE)*
2. Play back the show. Verify that playback succeeds and is completed without any image or sound distortions and without any interruption. Incomplete or interrupted playback or the presence of distortions or artifacts shall be cause to fail this test.

Supporting Materials

Reference Documents	DCI-DCSS, 7.4.1.8
Test Materials	<i>DCI 2K Sync Test with subtitles (OBAE) (Encrypted)</i> <i>KDM for DCI 2K Sync Test with subtitles (OBAE) (Encrypted)</i> <i>OBAE Rendering Expectations (Clip)</i> <i>DCI 2K StEM (OBAE) (Encrypted)</i> <i>KDM for 2K StEM (Encrypted) (OBAE)</i>

Consolidated Test Sequences

Sequence	Type	Measured Data
20.2. OMB Test Sequence	Pass/Fail	—
21.2. Integrated IMBO Test Sequence	Pass/Fail	—

8.2.17. Restarting Playback (OBAE)

Objective

Verify that power failures cause the system to enter a stable stop/idle condition and that the OBAE-capable system provides the ability to restart playback at a point prior to a power interruption.

Procedures

1. Load *DCI 2K Image with Frame Number Burn In (OBAE) (Encrypted)* and *KDM for DCI 2K Image with Frame Number Burn In (OBAE) (Encrypted)*, then assemble and start a show.
2. Interrupt the presentation by interrupting the Test Subject's power supply. If possible, a projector power supply should not be interrupted as this may cause overheating and damage the projector.
3. Re-establish power and verify that the system enters a stable stop/idle state. Failure to meet this requirement is cause to fail this test.
4. Verify that the system notifies the user that the last playback was abnormally interrupted, and offers the possibility of restarting the show. Failure to meet this requirement is cause to fail this test.
5. Attempt to restart the presentation at a point prior to the power interruption and verify that the restart was successful. Failure to meet this requirement is cause to fail this test.

Supporting Materials

Reference Documents	DCI-DCSS, 7.2.3.13, 7.4.1.2, 7.4.1.8
Test Materials	<i>KDM for DCI 2K Image with Frame Number Burn In (OBAE) (Encrypted)</i> <i>DCI 2K Image with Frame Number Burn In (OBAE) (Encrypted)</i>

Consolidated Test Sequences

Sequence	Type	Measured Data
20.2. OMB Test Sequence	Pass/Fail	—
21.2. Integrated IMBO Test Sequence	Pass/Fail	—

8.2.18. Show Playlist Creation (OBAE)

Objective

- Verify that the OBAE-capable SMS provides the necessary functions for managing Composition Play Lists (CPLs) and for assembling them into shows (SPL creation).
- Verify that the OBAE-capable SMS allows only authorized persons to build a Show Playlist (SPL).

Procedures

1. Ingest the composition *DCI 2K StEM (OBAE)* into the system.
2. Using the system, locate the composition *DCI 2K StEM (OBAE)*.
3. Create a new Show Play List (SPL) and add *DCI 2K StEM (OBAE)* twice to the show. The two instances of *DCI 2K StEM (OBAE)* are herein referred to as *DCI 2K StEM (OBAE) X* and *DCI 2K StEM (OBAE) Y*.
4. Ingest the composition *DCI 2K StEM (OBAE) (Encrypted)* and the *KDM KDM for 2K StEM (Encrypted) (OBAE)* into the system.
5. Using the system, locate the composition *DCI 2K StEM (OBAE) (Encrypted)*.
6. Append the composition *DCI 2K StEM (OBAE) (Encrypted)* to the end of the show.
7. In the show, move the composition *DCI 2K StEM (OBAE) (Encrypted)* in between *DCI 2K StEM (OBAE) X* and *DCI 2K StEM (OBAE) Y*.
8. Ingest *DCI Black Spacer - 5 seconds* and insert it between each of the compositions in the show.
9. Start playback and verify that the presentation proceeds as expected and the inserted black frames and silence are presented correctly.
10. Attempt to delete each of the compositions *DCI 2K StEM (OBAE)*, *DCI 2K StEM (Encrypted)* and *DCI Black Spacer - 5 seconds* from system storage. The system is required to warn that the content is part of a current show and not allow deletion.
11. Wait until playback is completed.
12. Remove *DCI 2K StEM (OBAE) X* from the show.
13. Attempt to delete *DCI 2K StEM (OBAE)* from storage. It is expected that the SMS warns the user that this composition is part of an SPL.

14. Delete the show then delete *DCI 2K StEM (OBAE)* and *DCI 2K StEM (OBAE) (Encrypted)*. It is expected that this operation succeeds.
15. Verify that the aforementioned compositions have been removed.
16. Verify that the above functions for assembling content into an SPL are executable with an easy to use graphical user interface.

Supporting Materials

Reference Documents	DCI-DCSS, 7.2.3.5, 7.2.3.7, 7.3.4, 7.4.1.1, 7.4.1.2, 7.4.1.3, 7.4.1.4, 7.4.1.5, 7.4.1.6
Test Materials	<i>DCI 2K StEM (OBAE)</i> <i>DCI 2K StEM (OBAE) (Encrypted)</i> <i>KDM for 2K StEM (Encrypted) (OBAE)</i> <i>DCI Black Spacer - 5 seconds</i>

Consolidated Test Sequences

Sequence	Type	Measured Data
20.2. OMB Test Sequence	Data only	—
21.2. Integrated IMBO Test Sequence	Data only	—

8.2.19. Deleted Section

The section "Automation Control and Interfaces (OBAE)" was deleted. The section number is maintained here to preserve the numbering of subsequent sections.

8.2.20. SMS Operator Identification (OBAE)

Objective

Verify that the security system requires the SMS and SMS operator to be identified to the OBAE-capable Security Manager.

Procedures

1. List all the methods available to the Test Subject that can cause playback of a composition or show. This could include any preset or created user accounts/logins to the SMS/TMS, direct command, e.g., by front panel controls or automation inputs and events initiated by an automatic scheduler. Manufacturer-supplied documentation, including manuals, may be consulted to assist with this step.
2. For each of the cases from the list created in Step 1, cause the composition *DCI 2K StEM (OBAE) (Encrypted)*, or a show that contains it, to play back. Record the time of day at the end of each playback.
3. Retrieve the audit logs from the system.

4. By using the time values recorded in Step 2, for each of the cases from the list created in Step 1:
 - a. Locate the corresponding `FrameSequencePlayed` playout events.
 - b. Verify that there is a `FrameSequencePlayed` event for both audio and image and that they each contain a parameter named `AuthId` with a value that is not absent.
 - c. Record each `AuthId` value. Any missing `AuthId` parameter or any `AuthId` parameter that has a value that is unpopulated is cause to fail this test.

Supporting Materials

Reference Documents	DCI-DCSS, 9.4.1.1
Test Materials	<i>DCI 2K StEM (OBAE) (Encrypted)</i> <i>KDM for 2K StEM (Encrypted) (OBAE)</i>

Consolidated Test Sequences

Sequence	Type	Measured Data
20.2. OMB Test Sequence	Pass/Fail	—

PART II. DESIGN EVALUATION GUIDELINES

Chapter 9. FIPS Requirements for a Type 1 SPB

Type 1 Secure Processing Blocks (SPB) are required by DCI to conform to a U.S. National Institute of Standards and Technology (NIST) FIPS 140 version in effect at the time of DCI compliance testing. Testing for compliance with FIPS 140 is performed by independent CMVP testing laboratories accredited by NIST NVLAP.

In May 2019, NIST announced the plan and schedule to migrate the security requirements for cryptographic modules from FIPS 140-2 to FIPS 140-3. In order to simplify accommodation of this [Chapter 9. FIPS Requirements for a Type 1 SPB](#) for FIPS 140-2 and FIPS 140-3 (and references to these documents throughout the CTP), FIPS 140-2 and FIPS 140-3 references have been revised to refer generically to FIPS 140, unless otherwise noted.

The testing program, known as the Cryptographic Module Validation Program (CMVP), is a joint effort of NIST's Computer Systems Laboratory (CSL) and the Communications Security Establishment (CSE) of the Government of Canada. More information about CMVP can be found on the NIST web site at <http://csrc.nist.gov/groups/STM/>. To be compliant with the DCI System Specification, a Type 1 SPB device must be tested by an accredited CMVP testing laboratory, the resulting documentation must be submitted to NIST/CSE for examination, and a validation certificate must be issued by NIST/CSE. Throughout this document, the term "FIPS 140-2 testing" will refer to this entire process.

FIPS 140 testing is very thorough but also very selective. To determine whether Type 1 SPB meets the DCI requirements, the documents prepared for and presented to the CMVP testing laboratory by the manufacturer must be reviewed by an examiner as guided by the requirements presented in this chapter. This chapter will briefly explain the FIPS testing process and the

documentation that is produced. A procedure will be presented that will guide the examiner through the task of evaluating a FIPS 140 test report and determining the DCI compliance status of the respective Test Subject.

9.1. FIPS Testing Procedures

This section will explain the process of obtaining a FIPS 140 validation certificate from NIST/CSE. This information is intended to guide the examiner in understanding the documentation that will be produced in that process. This information is not exhaustive and is not intended to guide a manufacturer in obtaining a validation certificate. The following sub-sections illustrate the tasks in a typical validation process.

Accredited CMVP Testing Laboratory

FIPS 140 testing is performed by an accredited CMVP testing laboratory. This CMVP testing laboratory will assist the manufacturer in preparing the required documentation and will test sample devices for conformance to the documentation. The CMVP testing laboratory may help the manufacturer resolve compliance issues in the design, but this help is limited to comments on proposed designs, actual design participation may not occur. The documentation and test reports may be submitted to NIST/CSE by the CMVP testing laboratory or the manufacturer.

NIST makes available the list of accredited CMVP testing laboratories on the agency web site (see http://csrc.nist.gov/groups/STM/testing_labs/index.html). Any of the testing laboratories can be used, but some restrictions may apply. For example, a laboratory that is owned by the Test Subject manufacturer or one that contributed to the design of the Test Subject will be disqualified from testing that Test Subject. More information about CMVP testing laboratories and CMVP testing laboratory selection can be found in *Frequently Asked Questions for the Cryptographic Module Validation Program* (<http://csrc.nist.gov/groups/STM/cmvp/documents/CMVPFAQ.pdf>).

Note:

The FIPS 140 validation test report prepared by the CMVP testing laboratory is a proprietary and closely controlled document. The manufacturer must ensure that it has permission to disclose the test report to the Testing Organization.

Standards and Supporting Documentation

The manufacturer must obtain and understand all of the NIST documentation that is relevant to the FIPS 140 testing process. In addition to the documentation about the validation process itself, the manufacturer will also need documentation which addresses the requirements for particular algorithms implemented in the device.

Security Element Documentation

All design elements which are addressed by FIPS 140, e.g., cryptographic algorithms and Critical Security Parameters (CSP), must be documented and tested according to CMVP procedures. The manufacturer must work with the CMVP testing laboratory to identify all such design features and prepare the required documentation.

Design Modification

The Cryptographic Algorithm Validation Program (CAVP) and CMVP validation testing processes may require design modifications to the cryptographic module hardware, software, firmware, or documentation. The CMVP testing laboratory performing the validation testing identifies the compliance issues, but does not design or redesign the cryptographic module with the manufacturer, or for the manufacturer.

Note:

The manufacturer is responsible for implementing a compliant design, and submitting required testing evidence to the CMVP testing laboratory for review and testing

Test Subject Instrumentation

Where it is not possible to test a particular subsystem from outside the module (e.g., the seed method for a random number generator), the manufacturer must provide the instrumentation necessary to allow the CMVP testing

laboratory to test the subsystem. A simulator may be used, for example, to prove the correct functioning of microcode for an ASIC or FPGA.

Additionally, the manufacturer may be required to develop test jigs to facilitate the error injection process; for example, to simulate tamper events and other hardware failures.

Operational Testing

The CMVP testing laboratory exercises the cryptographic module through all major states, including error states, while monitoring all external ports and interfaces using manufacturer testing tools and equipment. This may require the ability to manipulate program execution and record the contents of memory, thus requiring instrumentation as described above.

Report Submission

Upon successful completion of the validation testing (no failed test assertions exist), the CMVP testing laboratory submits a FIPS 140-2 validation report to the CMVP for certification. CMVP personnel examine the submission for correctness, sending any necessary requests for clarification to the CMVP testing laboratory. The submission may be rejected, in which case the manufacturer and CMVP testing laboratory must work to resolve the issue(s) raised and re-submit the validation report. Once the submission is accepted by CMVP, a certificate is issued for the cryptographic module.

The CMVP maintains a list of all cryptographic modules validated to FIPS 140 requirements. This list is published online at <http://csrc.nist.gov/groups/STM/cmvp/validation.html>. The CMVP also maintains a list of cryptographic modules currently undergoing FIPS 140 testing (a listing on the CMVP pre-validation website does not equate to having a FIPS 140-2 validation). The pre-validation list is at <http://csrc.nist.gov/groups/STM/cmvp/inprocess.html>.

Maintenance

Changes to the module design require re-validation. The effort required to validate an updated design may be small if the design changes are minor.

9.2. Submitted Materials

The CMVP testing laboratory will review and analyze design materials during the validation testing process. The following list shows the documents generally expected to be submitted.

- Master Components List (bill of materials); All items submitted as test evidence to the CMVP testing laboratory (*e.g.*, software, firmware, hardware, source code, documentation, etc.) must be specified on the Master Components List, along with a unique identifier and version
- Production grade samples of the cryptographic module (minimum of five for Level 3)
- Security policy
- Data sheets for hardware components
- Listing of all significant information flows
- Finite state model
- Clearly annotated source code
- Functional specifications
- Block diagrams
- Schematics

- VHDL for custom components
- Software design documentation (such as an API or developers guide)
- Mechanical drawings & assembly drawings (approximately to scale)
- Printed circuit board layout drawings
- Cryptographic Key and Critical Security Parameter documentation
- Delivery and operations procedures
- Cryptographic Officer & User guidance
- Configuration management specification
- Operational testing plan(s), and associated testing equipment
- Rationale for exclusion of any components from the security requirements of FIPS 140
- Proof of conformance to FCC Part 15, Subpart B Class A requirements
- CAVP Algorithm validation certificates for all implemented Approved cryptographic algorithms
- Documentation detailing the correspondence of all security rules to the implementation

9.3. CMVP Testing Laboratory Reports

A FIPS 140 validation test report is created by CMVP testing laboratory engineers for submission to CMVP. The report details the documentation received and the test engineer's evaluation of the implementation's fidelity to the documentation and FIPS 140 requirements. The module tested receives a FIPS 140 validation certificate (i.e., either [FIPS-140-2] or [FIPS-140-3]) once the CMVP reviews and approves the test report.

9.4. Interpreting FIPS Test Reports

The CMVP testing laboratory assessments contained within a FIPS 140 validation test report address each of the applicable "TE" requirements corresponding to the eleven areas specified in the FIPS 140 Derived Test Requirements (DTR). These requirements instruct the tester as to what he or she must do in order to test the cryptographic module with respect to the given assertion (which is a statement that must be true for the module to satisfy the requirement of a given area at a given level).

For each applicable FIPS 140 "TE", the tester's assessment includes:

- A statement that the tester verified the requirement was satisfied, or that the requirement is not applicable
- Details on how the tester verified the requirement (e.g. through documentation review, source code analysis, physical attack, operational testing, etc.).
- References to supporting design documentation and other test evidence
- References to algorithm standards and CAVP validation certificates as applicable

The Testing Organization must obtain an official copy of the FIPS 140 validation test report directly from the CMVP testing laboratory that performed the testing. The Test Operator must verify that the name of the cryptographic module and version (software, hardware, firmware) under review are identical to the versions reviewed for the FIPS 140 validation certificate, and supporting CAVP algorithm validation certificate(s).

To confirm whether the cryptographic module satisfies the DCI requirements, the Test Operator must review the "TE" assessments (and associated references as needed) that are relevant to corresponding DCI requirements (the specific assessments are located below with the respective DCI requirements. The functionality described must be consistent with the observed implementation.

9.5. DCI Requirements for FIPS Modules

Each of the subsections below describes a DCI requirement that must be proven by examining the FIPS 140 validation report. For each requirement, observe the design of the respective system element (with the aid of the Test Subject Representative) and record whether or not the design meets the requirement.

9.5.1. SM Operating Environment

Verify that the Security Manager (SM) operating environment is limited to the FIPS 140 "limited operational" or "non-modifiable operational" environment category.

Reference Documents	DCI-DCSS, 9.4.2.4, 9.5.2.5, 9.5.2.7 FIPS-140-2 FIPS-140-3
----------------------------	---

Sequence	Type
15.3. Integrated IMB Design Review	Pass/Fail
20.3. OMB Design Review	Pass/Fail
21.3. Integrated IMBO Design Review	Pass/Fail

9.5.2. Deleted Section

The section "LE Key Generation" was deleted. The section number is maintained here to preserve the numbering of subsequent sections.

9.5.3. SPB Type 1 Tamper Responsiveness

For components of the system designated *Type 1 SPB*, verify the following:

1. That SPBs with access doors or removable covers are monitored 24/7 to assure that in the event of intrusion via such openings the SPB terminates all activity and zeroizes all Critical Security Parameters (CSPs) (see [DCI-DCSS], Section 9.5.2.6).
2. That if the SPB requires a power source to accomplish tamper detection and response, it must zeroize its CSPs prior to any situation arising where such power source may not be available.
3. That log records are not purged in the event of intrusion or other tamper detection

Reference Documents	DCI-DCSS, 9.4.3.6.3, 9.5.2.2, 9.5.2.5, 9.5.2.6 FIPS-140-2 FIPS-140-3
----------------------------	--

Sequence	Type
15.3. Integrated IMB Design Review	Pass/Fail
20.3. OMB Design Review	Pass/Fail

21.3. Integrated IMBO Design Review	Pass/Fail
-------------------------------------	-----------

9.5.4. Deleted Section

The section "Security Design Description Requirements" was deleted. The section number is maintained here to preserve the numbering of subsequent sections.

9.5.5. Deleted Section

The section "SPB1 Tamper Resistance" was deleted. The section number is maintained here to preserve the numbering of subsequent sections.

9.5.6. SPB Type 1 FIPS Requirements

For components of the system designated *Type 1 SPB*, verify the following: the component meets and is certified for the requirements of FIPS 140 Level 3 in all areas except those subject to the exceptions or additional notes as specified in [DCI-DCSS], Section 9.5.2.5.

Reference Documents	DCI-DCSS, 9.5.2.5 FIPS-140-2 FIPS-140-3
----------------------------	---

Sequence	Type
15.3. Integrated IMB Design Review	Pass/Fail
20.3. OMB Design Review	Pass/Fail
21.3. Integrated IMBO Design Review	Pass/Fail

9.5.7. Deleted Section

The section "SPB1 Secure Silicon FIPS Requirements" was deleted. The section number is maintained here to preserve the numbering of subsequent sections.

9.5.8. Asymmetric Key Generation

For components of the system designated *Type 1 SPB*, verify that keys are generated as specified in [RFC-3447] and per the requirements of FIPS 140 "Cryptographic Key Management" and the [DCI-DCSS], Section 9.5.2.5.

Reference Documents	DCI-DCSS, 9.5.2.5, 9.7.6 RFC-3447 FIPS-140-2 FIPS-140-3
----------------------------	--

Sequence	Type
15.3. Integrated IMB Design Review	Pass/Fail
20.3. OMB Design Review	Pass/Fail
21.3. Integrated IMBO Design Review	Pass/Fail

9.5.9. Critical Security Parameter Protection

Verify that the following Critical Security Parameters (CSPs) receive Secure Processing Block (SPB) Type 1 protection, whenever they exist outside of their originally encrypted state, in accordance with IPS-140 and the requirements of

[DCI-DCSS], Section 9.5.2.5:

1. Device Private Keys - RSA private key that devices use to prove their identity and facilitate secure Transport Layer Security (TLS) communications.
2. Content Encryption Keys - Key Delivery Message (KDM) AES keys that protect content.
3. Content Integrity Keys - HMAC-SHA-1 keys that protect the integrity of compressed content (integrity pack check parameters).
4. *This step has been deleted*
5. *This step has been deleted*
6. *This step has been deleted*

Reference Documents	DCI-DCSS, 9.5.2.5, 9.5.2.6 FIPS-140-2 FIPS-140-3
----------------------------	--

Sequence	Type
15.3. Integrated IMB Design Review	Pass/Fail
20.3. OMB Design Review	Pass/Fail
21.3. Integrated IMBO Design Review	Pass/Fail

9.5.10. Deleted Section

The section "SPB 1 Firmware Modifications" was deleted. The section number is maintained here to preserve the numbering of subsequent sections.

9.5.11. Degraded mode(s) of operation prohibited

This procedure is applicable only to FIPS-140-3 certification.

Verify that degraded mode(s) of operation, as defined in FIPS-140-3, are not implemented.

Reference Documents	DCI-DCSS, 9.5.2.5.1 FIPS-140-3
----------------------------	-----------------------------------

Sequence	Type
15.3. Integrated IMB Design Review	Pass/Fail
20.3. OMB Design Review	Pass/Fail
21.3. Integrated IMBO Design Review	Pass/Fail

9.5.12. Control output inhibition

This procedure is applicable only to FIPS-140-3 certification.

Verify that the SPB Type 1 inhibits its control output interface during each error state, as specified in FIPS-140-3.

Reference Documents	DCI-DCSS, 9.5.2.5.1
----------------------------	---------------------

FIPS-140-3

Sequence	Type
15.3. Integrated IMB Design Review	Pass/Fail
20.3. OMB Design Review	Pass/Fail
21.3. Integrated IMBO Design Review	Pass/Fail

9.5.13. Maintenance role/interface prohibited

This procedure is applicable only to FIPS-140-3 certification.

Verify that a maintenance role/interface, as defined in FIPS-140-3, is not implemented.

Reference Documents	DCI-DCSS, 9.5.2.5.1 FIPS-140-3
----------------------------	-----------------------------------

Sequence	Type
15.3. Integrated IMB Design Review	Pass/Fail
20.3. OMB Design Review	Pass/Fail
21.3. Integrated IMBO Design Review	Pass/Fail

9.5.14. Self-initiated cryptographic output capability

This procedure is applicable only to FIPS-140-3 certification.

Verify that, if the SPB Type 1 supports "self-initiated cryptographic output capability," that a User Role and/or Crypto Officer Role is required to support the AuthorityID requirements of DCI-DCSS, 9.4.2.5.

Reference Documents	DCI-DCSS, 9.5.2.5.1, 9.4.2.5 FIPS-140-3
----------------------------	--

Sequence	Type
15.3. Integrated IMB Design Review	Pass/Fail
20.3. OMB Design Review	Pass/Fail
21.3. Integrated IMBO Design Review	Pass/Fail

9.5.15. Self-initiated cryptographic output capability

This procedure is applicable only to FIPS-140-3 certification.

Verify the strength and hardness of SPB Type 1 physical security enclosure material(s) are sustained over the SPB Type 1's range of operation, storage, and distribution by review of design documentation. Verify that destructive physical attacks performed on SPB-1 at nominal temperature(s) verified the strength and hardness of SPB Type 1 physical security enclosure material(s).

Reference Documents	DCI-DCSS, 9.5.2.5.1 FIPS-140-3
----------------------------	-----------------------------------



Sequence	Type
15.3. Integrated IMB Design Review	Pass/Fail
20.3. OMB Design Review	Pass/Fail
21.3. Integrated IMBO Design Review	Pass/Fail

9.5.16. Periodic self-tests

This procedure is applicable only to FIPS-140-3 certification.

Verify that the specified Security Policy maximum time between periodic self-tests, as defined in FIPS-140-3, is not more than one week.

Reference Documents	DCI-DCSS, 9.5.2.5.1 FIPS-140-3
----------------------------	-----------------------------------

Sequence	Type
15.3. Integrated IMB Design Review	Pass/Fail
20.3. OMB Design Review	Pass/Fail
21.3. Integrated IMBO Design Review	Pass/Fail

Chapter 10. DCI Requirements Review

Like the previous chapter, this chapter contains procedures for evaluating system design for fidelity to DCI requirements that cannot be tested by direct examination of a finished product. These requirements are different though, because they are not proven by the FIPS 140 certification process. The process of proving these requirements is the same, however. Documentation must be produced and Test Subjects must be instrumented to give the examiner all necessary information to evaluate the design. Manufacturers must produce proof in the form of design documentation for each of the applicable requirement specified in this Chapter. To see which requirements are relevant to a particular Test Subject consult the Design Review sections of Part III. Consolidated Test Procedures.)

To complete a compliance evaluation using the requirements in this section, the examiner must be presented with the documentation detailed below. The examiner must also have access to a Test Sample (a production-grade sample of the system, conforming to the operational capabilities of the Design Review sequence being used). Wherever possible, the examiner should confirm that the documentation matches the Test Sample.

10.1. Type 1 SPB Documentation

For a Type 1 SPB, it should be possible to validate the requirements in this chapter using much of the test material produced for the FIPS 140 test. It may be necessary for the manufacturer to provide additional information in the case where a requirement is not provable using documentation prepared with only the FIPS 140 test in mind. Manufacturers are encouraged to consider the objectives of this chapter when preparing material for the FIPS 140 test of a Type 1 SPB.

The following documents (repeated from Chapter 9) are examples of the types of documentation that will be useful when proving compliance with the requirements presented in this chapter:

- Master Components List (bill of materials); All items submitted as test evidence to the Testing Organization (e.g., software, firmware, hardware, source code, documentation, etc.) must be specified on the Master Components List, along with a unique identifier and version
- Security policy

- Data sheets for hardware components
- Listing of all significant information flows
- Finite state model
- Clearly annotated source code
- Functional specifications
- Block diagrams
- Schematics
- Software design documentation (such as an API or developers guide)
- Mechanical drawings & assembly drawings (approximately to scale)
- Printed circuit board layout drawings
- Cryptographic Key and Critical Security Parameter documentation
- Delivery and operations procedures
- Cryptographic Officer & User guidance
- Configuration management specification
- Operational testing plan(s), and associated testing equipment
- Documentation detailing the correspondence of all security rules to the implementation

10.2. Type 2 SPB Documentation

For a Type 2 SPB, it is necessary to produce documentation to validate the requirements in this chapter. Because a Type 2 SPB is not required to undergo FIPS 140 testing, this documentation will be produced only for the purpose of this DCI compliance test. Note that the documentation need not cover aspects of the design that are not the subject of the requirements.

The following documentation must be supplied:

- Block diagrams showing chassis partitions, major components, locations of security components, security parameters and security related information flows.
- Descriptions and functions of all electronic interfaces and user interfaces, for both security and non-security operations. (Proprietary details of non-security related interfaces are not required, however enough information must be supplied to allow the examiner to prove that all security-related interfaces have been fully documented).
- User and maintenance manual information relating to security, *i.e.* installation and operation details including user and maintenance roles for electronic access and detailed declarations of capabilities for each role. Also include check lists or instructions from user or maintenance documentation that contain information suggesting security-related instructions, recommended practices, etc. for users and maintenance personnel.
- Analysis of user and maintenance role capabilities reconciled against DCI requirements for "non-security" vs. "security" related access and maintenance.

- Finite state model, limited to SPB-2 security functional operation (including interaction with the companion type-1 SPB, as applicable).

In addition to the above, any documentation that can be used to prove that the design meets a particular requirement should be provided.

10.3. Forensic Mark IP Disclosure

For a Test Subject which implements Forensic Marking (FM), it will be necessary to provide, in addition to the documentation listed above, an intellectual property disclosure statement which describes any claims on intellectual property that the manufacturer intends to make on the FM algorithm.

10.4. DCI Requirements for Security Modules

Each of the subsections below describes a DCI requirement that must be proven by examining the manufacturer's documentation.

10.4.1. Theater System Reliability

- Verify that the Mean Time Between Failure (MTBF) for the Test Subject, as reported by the manufacturer, is not less than 10,000 hours.
- Verify that the Mean Time to Repair (MTR) for the Test Subject, as reported by the manufacturer, does not exceed 2 hours. The MTR does not include transit time, i.e., all parts and tools are assumed to be immediately at hand.

Reference Documents	DCI-DCSS, 7.2.3.1, 7.2.3.2
----------------------------	----------------------------

Sequence	Type
15.3. Integrated IMB Design Review	Pass/Fail
20.3. OMB Design Review	Pass/Fail
21.3. Integrated IMBO Design Review	Pass/Fail
24.3. SDR Projector Design Review	Pass/Fail
26.3. HDR Direct View Display Design Review	Pass/Fail
27.3. SDR Direct View Display Design Review	Pass/Fail
28.3. HDR Projector Design Review	Pass/Fail

10.4.2. Theater System Storage Security

- Verify that image and audio essence on storage devices retains its original AES encryption, if present during ingest.
- Verify that decrypted plaintext (image or audio) essence is never stored on the storage system.
- Verify that with the exception of subtitle essence, encrypted essence files are decrypted only in real-time during playback.

Reference Documents	DCI-DCSS, 7.5.3.8, 9.4.1
----------------------------	--------------------------

Sequence	Type
15.3. Integrated IMB Design Review	Pass/Fail

20.3. OMB Design Review	Pass/Fail
21.3. Integrated IMBO Design Review	Pass/Fail

10.4.3. Deleted Section

The section "Security Devices Self-Test Capabilities" was deleted. The section number is maintained here to preserve the numbering of subsequent sections.

10.4.4. Security Entity Physical Protection

Verify that the following Security Entities (SE) are contained within Type 1 SPBs:

- Security Manager (SM)
- Media Decryptor (MD)
- Forensic Marker (FM)

Reference Documents	DCI-DCSS, 9.4.1.1, 9.3.3.2
----------------------------	----------------------------

Sequence	Type
15.3. Integrated IMB Design Review	Pass/Fail
20.3. OMB Design Review	Pass/Fail
21.3. Integrated IMBO Design Review	Pass/Fail

10.4.5. Secure SMS-SM Communication

Does not apply to an SMS that is permanently integrated.

Verify that the SMS communicates with the SM under its control using:

- TLS 1.0, 1.2 or 1.3;
- the cipher suite TLS_RSA_WITH_AES_128_CBC_SHA, as defined in [RFC-3268], when TLS 1.0 is used.

Reference Documents	[RFC-2246] [RFC-2246] [RFC-8446] [RFC-3268] DCI-DCSS, 9.4.1.1, 9.4.2.5
----------------------------	--

Sequence	Type
15.3. Integrated IMB Design Review	Pass/Fail
20.3. OMB Design Review	Pass/Fail
21.3. Integrated IMBO Design Review	Pass/Fail

10.4.6. Location of Security Manager

Using the definition of a Security Manager (SM) and its functions specified in Sections 9.4.2.4, 9.4.3.5, 9.6.1 and 9.6.1.2 of [DCI-DCSS]:

- Verify that each Media Block (MB) contains all the functions of exactly one SM.

- Verify that no SM function is implemented outside the Secure Processing Block Type 1 (SPB Type 1) boundaries of an MB.

Reference Documents	DCI-DCSS, 9.4.2.4, 9.4.3.5, 9.6.1, 9.6.1.2
----------------------------	--

Sequence	Type
15.3. Integrated IMB Design Review	Pass/Fail
20.3. OMB Design Review	Pass/Fail
21.3. Integrated IMBO Design Review	Pass/Fail

10.4.7. Deleted Section

The section "SM Usage of OS Security Features" was deleted. The section number is maintained here to preserve the numbering of subsequent sections.

10.4.8. Deleted Section

The section "Secure Remote SPB-SM Communications" was deleted. The section number is maintained here to preserve the numbering of subsequent sections.

10.4.9. Deleted Section

The section "Playback Preparation" was deleted. The section number is maintained here to preserve the numbering of subsequent sections.

10.4.10. Deleted Section

The section "Special Auditorium Situation Detection" was deleted. The section number is maintained here to preserve the numbering of subsequent sections.

10.4.11. Deleted Section

The section "Prevention of Keying of Compromised SPBs" was deleted. The section number is maintained here to preserve the numbering of subsequent sections.

10.4.12. Deleted Section

The section "SPB Authentication" was deleted. The section number is maintained here to preserve the numbering of subsequent sections.

10.4.13. TLS Session Key Refreshes

The section "TLS Session Key Refreshes" was deleted. The section number is maintained here to preserve the numbering of subsequent sections.

10.4.14. LE Key Issuance

The section "LE Key Issuance" was deleted. The section number is maintained here to preserve the numbering of subsequent sections.

10.4.15. Maximum Key Validity Period

The section "Maximum Key Validity Period" was deleted. The section number is maintained here to preserve the numbering of subsequent sections.

10.4.16. KDM Purge upon Expiry

Verify that the Security Manager (SM) deletes from its storage a Key Delivery Message (KDM) (and associated keys) no later than 10 minutes after its playout time window has expired (passed), unless playout is started within the KDM playout time window but the playout time window expires before the end of playout. In the latter case, verify that the SM deletes from its storage the KDM (and associated keys) no later than 10 minutes after (i) the end of the show or (ii) the end of the six (6) hour period following the end of the KDM playout time window, whichever comes first.

Reference Documents	DCI-DCSS, 9.4.3.5
----------------------------	-------------------

Sequence	Type
15.3. Integrated IMB Design Review	Pass/Fail
20.3. OMB Design Review	Pass/Fail
21.3. Integrated IMBO Design Review	Pass/Fail

10.4.17. Deleted Section

The section "Key Usage Time Window" was deleted. The section number is maintained here to preserve the numbering of subsequent sections

10.4.18. Imaging Device Secure Silicon Device

Verify that the Imaging Device SPB includes a secure silicon host device (see Section 9.4.3.6.1 of [DCI-DCSS]) that contains the SPB's digital certificate.

Reference Documents	DCI-DCSS, 9.4.3.6.1
----------------------------	---------------------

Sequence	Type
24.3. SDR Projector Design Review	Pass/Fail
26.3. HDR Direct View Display Design Review	Pass/Fail
27.3. SDR Direct View Display Design Review	Pass/Fail
28.3. HDR Projector Design Review	Pass/Fail

10.4.19. Access to Imaging Device Image Signals

Verify that the Imaging Device SPB design does not allow physical access to signals running between the companion SPB and the Imaging Device SPB without breaking the marriage.

Reference Documents	DCI-DCSS, 9.4.3.6.1
----------------------------	---------------------

Sequence	Type
24.3. SDR Projector Design Review	Pass/Fail
26.3. HDR Direct View Display Design Review	Pass/Fail
27.3. SDR Direct View Display Design Review	Pass/Fail
28.3. HDR Projector Design Review	Pass/Fail

10.4.20. Systems with Electronic Marriage

Verify that an electronic marriage is planned upon installation of a MB Imaging Device pair. Verify that this physical/ electrical connection is battery-backed and monitored 24/7 by the companion SPB and, if broken, shall require a reinstallation (re-marriage) process.

Reference Documents	DCI-DCSS, 9.4.3.6.1
----------------------------	---------------------

Sequence	Type
24.3. SDR Projector Design Review	Pass/Fail
26.3. HDR Direct View Display Design Review	Pass/Fail
27.3. SDR Direct View Display Design Review	Pass/Fail
28.3. HDR Projector Design Review	Pass/Fail

10.4.21. Systems Without Electronic Marriage

Verify that in the configuration of a permanently married companion SPB (MB) the companion SPB is not field replaceable and require the Imaging Device SPB and companion SPB system to both be replaced in the event of an SPB failure.

If the companion SPB is a *MB with single certificate implementation* as defined in Section 9.5.1.1 of [DCI-DCSS], verify that the system contains exactly one leaf certificate.

If the companion SPB is a *MB with dual certificate implementation* as defined in Section 9.5.1.2 of [DCI-DCSS], verify that the system contains exactly two leaf certificates.

Reference Documents	DCI-DCSS, 9.4.3.6.6, 9.5.1.1, 9.5.1.2
----------------------------	---------------------------------------

Sequence	Type
24.3. SDR Projector Design Review	Pass/Fail
26.3. HDR Direct View Display Design Review	Pass/Fail
27.3. SDR Direct View Display Design Review	Pass/Fail
28.3. HDR Projector Design Review	Pass/Fail

10.4.22. Clock Date-Time-Range

Verify that the MB clock has a Date-Time range of at least 20 years.

Reference Documents	DCI-DCSS, 9.4.3.7
----------------------------	-------------------

Sequence	Type
15.3. Integrated IMB Design Review	Pass/Fail
20.3. OMB Design Review	Pass/Fail
21.3. Integrated IMBO Design Review	Pass/Fail

10.4.23. Clock Setup

Verify that the SM clock is set by the manufacturer to within one second of UTC by means of a national time standard (such as WWV).

Reference Documents	DCI-DCSS, 9.4.3.7
----------------------------	-------------------

Sequence	Type
15.3. Integrated IMB Design Review	Pass/Fail
20.3. OMB Design Review	Pass/Fail
21.3. Integrated IMBO Design Review	Pass/Fail

10.4.24. Clock Stability

If the device is an SM, verify that the clock stability requirement of +/- 30 seconds per month is met.

Reference Documents	DCI-DCSS, 9.4.3.7
----------------------------	-------------------

Sequence	Type
15.3. Integrated IMB Design Review	Pass/Fail
20.3. OMB Design Review	Pass/Fail
21.3. Integrated IMBO Design Review	Pass/Fail

10.4.25. Repair and Renewal of SPBs

Verify that an SPB cannot be repaired or renewed without direct manufacturer action.

Reference Documents	DCI-DCSS, 9.5.2.3
----------------------------	-------------------

Sequence	Type
15.3. Integrated IMB Design Review	Pass/Fail
20.3. OMB Design Review	Pass/Fail
21.3. Integrated IMBO Design Review	Pass/Fail
24.3. SDR Projector Design Review	Pass/Fail
26.3. HDR Direct View Display Design Review	Pass/Fail
27.3. SDR Direct View Display Design Review	Pass/Fail
28.3. HDR Projector Design Review	Pass/Fail

10.4.26. SPB2 Protected Devices

Verify that Type 2 SPB surrounds the following sub-systems:

- a. security environment consisting of a secure silicon chip; input/output signals to the secure silicon chip and the Imaging Device SPB; perimeter access panel monitoring
- b. the Imaging Device image signal processing environment

Verify through physical inspection that a sample device contains the above listed sub-systems in a manner consistent with the documentation.

Reference Documents	DCI-DCSS, 9.5.2.4
----------------------------	-------------------

24.3. SDR Projector Design Review	Pass/Fail
26.3. HDR Direct View Display Design Review	Pass/Fail
27.3. SDR Direct View Display Design Review	Pass/Fail
28.3. HDR Projector Design Review	Pass/Fail

10.4.27. Clock Continuity

Verify that the clock is tamper-proof and thereafter may not be reset.

Reference Documents	DCI-DCSS, 9.4.3.7
----------------------------	-------------------

Sequence	Type
15.3. Integrated IMB Design Review	Pass/Fail
20.3. OMB Design Review	Pass/Fail
21.3. Integrated IMBO Design Review	Pass/Fail

10.4.28. Deleted Section

The section "TLS Endpoints" was deleted. The section number is maintained here to preserve the numbering of subsequent sections.

10.4.29. Deleted Section

The section "Implementation of RRP" was deleted. The section number is maintained here to preserve the numbering of subsequent sections.

10.4.30. Deleted Section

The section "SMS and SPB Authentication and ITM Transport Layer" was deleted. The section number is maintained here to preserve the numbering of subsequent sections.

10.4.31. Deleted Section

The section "Idempotency of ITM RRP" was deleted. The section number is maintained here to preserve the numbering of subsequent sections.

10.4.32. Deleted Section

The section "RRP Synchronism" was deleted. The section number is maintained here to preserve the numbering of subsequent sections.

10.4.33. Deleted Section

The section "TLS Mode Bypass Prohibition" was deleted. The section number is maintained here to preserve the numbering of subsequent sections.

10.4.34. Deleted Section

The section "RRP Broadcast Prohibition" was deleted. The section number is maintained here to preserve the numbering of subsequent sections.

10.4.35. Deleted Section

The section "Implementation of Proprietary ITMs" was deleted. The section number is maintained here to preserve the numbering of subsequent sections.

10.4.36. Deleted Section

The section "RRP Initiator" was deleted. The section number is maintained here to preserve the numbering of subsequent sections.

10.4.37. Deleted Section

The section "SPB TLS Session Partners" was deleted. The section number is maintained here to preserve the numbering of subsequent sections.

10.4.38. Deleted Section

The section "SM TLS Session Partners" was deleted. The section number is maintained here to preserve the numbering of subsequent sections.

10.4.39. Deleted Section

The section "RRP 'Busy' and Unsupported Types" was deleted. The section number is maintained here to preserve the numbering of subsequent sections.

10.4.40. Deleted Section

The section "RRP Operational Messages" was deleted. The section number is maintained here to preserve the numbering of subsequent sections.

10.4.41. Deleted Section

The section "FM Generic Inserter Requirements" was deleted. The section number is maintained here to preserve the numbering of subsequent sections.

10.4.42. FM Algorithm General Requirements

For a Forensic Marking (FM) embedder:

1. Verify that single distribution inventory is supported by the FM algorithm.
2. Verify by examination of the FM embedder intellectual property disclosure that the terms and conditions of use for the FM algorithm are reasonable and non-discriminatory (RAND).
3. Verify that detection can be performed by the manufacturer or the Rights Owner at the Rights Owner's premises.

Reference Documents	DCI-DCSS, 9.4.6.1.1
----------------------------	---------------------

Sequence	Type
15.3. Integrated IMB Design Review	Pass/Fail
20.3. OMB Design Review	Pass/Fail
21.3. Integrated IMBO Design Review	Pass/Fail

10.4.43. FM Insertion Requirements

- Verify that audio (main sound and OBAE, as applicable) and image FM insertion is a real-time (*i.e.*, show playback time), in-line process performed in the associated MB, and has a reasonable computational process.

- Verify that audio (main sound and OBAE, as applicable) and image FM is applied at the earliest point after decryption and prior to the essence being present on any data bus outside the MB.
- Verify that all FM inserters insert a unique 19-bit or 20-bit "location" Forensic Marking Identification (FMID) that is permanently associated with the associated MB.
- Verify that all FM inserters insert a 16-bit time stamp that increments by 1 every 15 minutes and resets to zero once per year.

Reference Documents	DCI-DCSS, 8.2.2.9, 9.4.6.1.1, 9.4.6.2(9)
----------------------------	--

Sequence	Type
15.3. Integrated IMB Design Review	Pass/Fail
20.3. OMB Design Review	Pass/Fail
21.3. Integrated IMBO Design Review	Pass/Fail

10.4.44. IFM Visual Transparency

Verify that IFM is visually transparent to the critical viewer in butterfly tests for motion image content.

Reference Documents	DCI-DCSS, 9.4.6.1.2
----------------------------	---------------------

Sequence	Type
15.3. Integrated IMB Design Review	Pass/Fail
21.3. Integrated IMBO Design Review	Pass/Fail

10.4.45. IFM Robustness

Verify that IFM resists/survives video processing attacks (such as digital-to-analog conversions, including multiple D-A/A-D conversions), re-sampling and re-quantization (including dithering and recompression), common signal enhancements to image contrast and color, resizing, letterboxing, aperture control, low-pass filtering, anti-aliasing, brick wall filtering, digital video noise reduction filtering, frame-swapping, compression, arbitrary scaling (aspect ratio is not necessarily constant), cropping, overwriting, addition of noise and other transformations. Verify that IFM survives collusion (the combining of multiple videos in the attempt to make a different fingerprint or to remove it), format conversion, the changing of frequencies and spatial resolution (among, for example, NTSC, PAL and SECAM, into another and vice versa), horizontal and vertical shifting and camcorder capture and low bit rate compression (e.g., 500 Kbps H264, 1.1 Mbps MPEG-1).

Reference Documents	DCI-DCSS, 9.4.6.1.2
----------------------------	---------------------

Sequence	Type
15.3. Integrated IMB Design Review	Pass/Fail
21.3. Integrated IMBO Design Review	Pass/Fail

10.4.46. AFM Inaudibility

Verify that AFM is inaudible in critical listening A/B tests

Reference Documents	DCI-DCSS, 9.4.6.1.3
----------------------------	---------------------

Sequence	Type
15.3. Integrated IMB Design Review	Pass/Fail
21.3. Integrated IMBO Design Review	Pass/Fail

10.4.47. AFM Robustness

Verify that AFM resists/survives multiple D/A and A/D conversions, radio frequency or infrared transmissions within the theater, any combination and down conversion of captured channels, re-sampling of channels, time compression/expansion with pitch shift and pitch preserved, linear speed changes within 10% and pitch-invariant time scaling within 4%. Verify that AFM resists/survives data reduction coding, nonlinear amplitude compression, additive or multiplicative noise frequency response distortion such as equalization, addition of echo, band-pass filtering, flutter and wow and overdubbing.

Reference Documents	DCI-DCSS, 9.4.6.1.3
----------------------------	---------------------

Sequence	Type
15.3. Integrated IMB Design Review	Pass/Fail
21.3. Integrated IMBO Design Review	Pass/Fail

10.4.48. FM Control Instance

Verify that the SM is solely responsible for control of FM marking processes (*i.e.*, "on/off") for the auditorium it is installed in and command and control of this function is only via the KDM indicator per [SMPTE-430-1] .

Reference Documents	DCI-DCSS, 9.4.6.2 SMPTE-430-1
----------------------------	----------------------------------

Sequence	Type
15.3. Integrated IMB Design Review	Pass/Fail
20.3. OMB Design Review	Pass/Fail
21.3. Integrated IMBO Design Review	Pass/Fail

10.4.49. Deleted Section

The section "SE Time Stamping" was deleted. The section number is maintained here to preserve the numbering of subsequent sections.

10.4.50. Deleted Section

The section "SE Log Authoring" was deleted. The section number is maintained here to preserve the numbering of subsequent sections.

10.4.51. SPB Log Storage Requirements

Verify that log records stored in SPBs are stored in non-volatile memory and are not purge-able. Verify that data is overwritten beginning with the oldest data as new log data is accumulated. Verify that no log records are overwritten unless collected by the SM..

Reference Documents	DCI-DCSS, 9.4.6.3.1
----------------------------	---------------------

Sequence	Type
15.3. Integrated IMB Design Review	Pass/Fail
20.3. OMB Design Review	Pass/Fail
21.3. Integrated IMBO Design Review	Pass/Fail

10.4.52. Deleted Section

The section "Remote SPB Log Storage Requirements" was deleted. The section number is maintained here to preserve the numbering of subsequent sections.

10.4.53. MB Log Storage Capabilities

Verify that the SM is capable of storing at least 12 months of typical log data accumulation for the auditorium in which it is installed.

Reference Documents	DCI-DCSS, 9.4.6.3.1
----------------------------	---------------------

Sequence	Type
15.3. Integrated IMB Design Review	Pass/Fail
20.3. OMB Design Review	Pass/Fail
21.3. Integrated IMBO Design Review	Pass/Fail

10.4.54. Deleted Section

The section "Logging for Standalone Systems" was deleted. The section number is maintained here to preserve the numbering of subsequent sections.

10.4.55. Deleted Section

The section "Logging of Failed Procedures" was deleted. The section number is maintained here to preserve the numbering of subsequent sections.

10.4.56. SPB Log Failure

Verify that behavior of security devices (SPB or SE) is specified and designed to immediately terminate operation, and requires replacement, upon any failure of its secure logging operation.

Reference Documents	DCI-DCSS, 9.4.6.3.10
----------------------------	----------------------

Sequence	Type
15.3. Integrated IMB Design Review	Pass/Fail
20.3. OMB Design Review	Pass/Fail
21.3. Integrated IMBO Design Review	Pass/Fail

10.4.57. Log Purging in Failed SPBs

Verify that resident log records in failed SPBs (and their contained SEs) are not purge-able except by authorized repair centers, which are capable of securely recovering such log records.

Reference Documents	DCI-DCSS, 9.4.6.3.10
----------------------------	----------------------

Sequence	Type
15.3. Integrated IMB Design Review	Pass/Fail
20.3. OMB Design Review	Pass/Fail
21.3. Integrated IMBO Design Review	Pass/Fail

10.4.58. MB Tasks

- Verify that, if included as part of the MB design, decryption and forensic marking of image essence is performed within the SPB boundary of the MB, and that the resulting image signal is passed to the Imaging Device SPB, as appropriate.
- Verify that, if included as part of the MB design, decryption and forensic marking of audio essence is performed within the SPB boundary of the MB, and that the resulting audio signal is passed to external components.
- Verify that, if included as part of the MB design, decryption, rendering and forensic marking of OBAE essence is performed within the SPB boundary of the MB, and that the resulting audio signal is passed to external components.
- Verify that, if included as part of the MB design, decryption of subtitle essence is performed within the SPB boundary of the MB, and that the resulting plaintext essence is passed to external components.

Reference Documents	DCI-DCSS, 9.4.3.6.3, 9.4.3.6.4
----------------------------	--------------------------------

Sequence	Type
15.3. Integrated IMB Design Review	Pass/Fail
20.3. OMB Design Review	Pass/Fail
21.3. Integrated IMBO Design Review	Pass/Fail

10.4.59. Type 1 SPB RSA Private Keys

- Verify that RSA private keys in a Type 1 SPB which constitute the subject of any certificate having an SM or LS role are (1) generated within the secure silicon device, (2) whether encrypted or not do not exist outside of the secure silicon device and (3) are not accessible to any process external to the secure silicon device.
- Verify that the entropy source (seed) used in the generation of the above RSA keys (1) is fully contained within the MB's SPB Type 1 and is not dependent on or influenced by any parameter or value external to the SPB, (2) does not enable the export of any information about the seed from the SPB.
- Verify that the CipherValue elements of the KDM's AuthenticatedPrivate element are decrypted by and within the secure silicon device.

Reference Documents	DCI-DCSS, 9.5.1, 9.5.2.2
----------------------------	--------------------------

Sequence	Type
15.3. Integrated IMB Design Review	Pass/Fail

20.3. OMB Design Review	Pass/Fail
21.3. Integrated IMBO Design Review	Pass/Fail

10.4.60. Content Keys Outside Secure Silicon

Verify that once decrypted from the KDM (and except when being used during playback) content keys are either cached within the secure silicon IC, or protected by AES key wrapping per [NIST-800-38F] when cached externally to secure silicon within the Media Block.

Reference Documents	DCI-DCSS, 9.5.1, 9.5.2.2, 9.7.4 NIST-800-38F
----------------------------	---

Sequence	Type
15.3. Integrated IMB Design Review	Pass/Fail
20.3. OMB Design Review	Pass/Fail
21.3. Integrated IMBO Design Review	Pass/Fail

10.4.61. Prohibition of SPB Type 1 Field Serviceability

Verify that SPBs of Type 1 are not field serviceable (e.g., SPB Type 1 maintenance access doors shall not be open-able in the field).

Reference Documents	DCI-DCSS, 9.5.2.3
----------------------------	-------------------

Sequence	Type
15.3. Integrated IMB Design Review	Pass/Fail
20.3. OMB Design Review	Pass/Fail
21.3. Integrated IMBO Design Review	Pass/Fail

10.4.62. Use of Software Protection Methods

Verify that software protection methods are not used to protect CSPs or content essence

Reference Documents	DCI-DCSS, 9.5.2.2
----------------------------	-------------------

Sequence	Type
15.3. Integrated IMB Design Review	Pass/Fail
20.3. OMB Design Review	Pass/Fail
21.3. Integrated IMBO Design Review	Pass/Fail

10.4.63. TMS Role

Verify that in the event that Exhibition command and control designs include the TMS as a device that interfaces with the SMS, such a TMS is viewed by the security system as an SMS, and carries a digital certificate and follows all other SMS behavior, TLS and ITM communications requirements.

Reference Documents	DCI-DCSS, 9.5.2.5
----------------------------	-------------------

Sequence	Type
15.3. Integrated IMB Design Review	Pass/Fail
20.3. OMB Design Review	Pass/Fail
21.3. Integrated IMBO Design Review	Pass/Fail

10.4.64. D-Cinema Security Parameter Protection

Verify that the following Digital Cinema Security Parameters (DCSPs) receive SPB Type 1 protection, whenever they exist outside of their originally encrypted state:

1. Watermarking or Fingerprinting command and control - Any of the parameters or keys used in a particular Forensic Marking process.
2. Logged Data - All log event data and associated parameters constituting a log record or report.

Reference Documents	DCI-DCSS, 9.5.2.6
----------------------------	-------------------

Sequence	Type
15.3. Integrated IMB Design Review	Pass/Fail
20.3. OMB Design Review	Pass/Fail
21.3. Integrated IMBO Design Review	Pass/Fail

10.4.65. RSA Key Entropy

Verify that the mechanism used to generate RSA key pairs must have at least 128-bits of entropy (unpredictability).

Reference Documents	DCI-DCSS, 9.7.6
----------------------------	-----------------

Sequence	Type
15.3. Integrated IMB Design Review	Pass/Fail
20.3. OMB Design Review	Pass/Fail
21.3. Integrated IMBO Design Review	Pass/Fail

10.4.66. Preloaded Symmetric Key Entropy

Verify that AES or TDES symmetric keys pre-loaded into a device are generated with a high quality random number generator with at least 128 bits of entropy (112 bits for TDES).

Reference Documents	DCI-DCSS, 9.7.6
----------------------------	-----------------

Sequence	Type
15.3. Integrated IMB Design Review	Pass/Fail
20.3. OMB Design Review	Pass/Fail
21.3. Integrated IMBO Design Review	Pass/Fail

10.4.67. Media Block Caching of Keys

Verify that the Media Block is capable of securely caching at least 512 keys.

Reference Documents	DCI-DCSS, 9.7.7
----------------------------	-----------------

Sequence	Type
15.3. Integrated IMB Design Review	Pass/Fail
20.3. OMB Design Review	Pass/Fail
21.3. Integrated IMBO Design Review	Pass/Fail

10.4.68. SPB Type 1 Firmware Modifications

Verify the following:

1. The device is designed such that the firmware cannot be modified without the knowledge and permission of the original manufacturer.
2. The device's firmware modification procedure requires a digital certificate per [SMPTE-430-2] that identifies the authority figure responsible for making the firmware change.
3. The device logs firmware change information including timestamp, version and operator identity

Reference Documents	DCI-DCSS, 9.5.2.7
----------------------------	-------------------

Sequence	Type
15.3. Integrated IMB Design Review	Pass/Fail
20.3. OMB Design Review	Pass/Fail
21.3. Integrated IMBO Design Review	Pass/Fail

10.4.69. SPB Type 1 Log Retention

Verify that log records are not purged from a Type 1 SPB in the event of intrusion or other tamper detection.

Reference Documents	DCI-DCSS, 9.4.3.6.3, 9.4.6.3.10
----------------------------	---------------------------------

Sequence	Type
15.3. Integrated IMB Design Review	Pass/Fail
20.3. OMB Design Review	Pass/Fail
21.3. Integrated IMBO Design Review	Pass/Fail

10.4.70. Deleted Section

The section "ASM Get Time Frequency" was deleted. The section number is maintained here to preserve the numbering of subsequent sections.

10.4.71. Deleted Section

The section "SPB2 Log Memory Availability" was deleted. The section number is maintained here to preserve the numbering of subsequent sections.

10.4.72. SPB Secure Silicon Requirements

Verify that the SPB's Secure Silicon device meets FIPS 140 level 3 "Physical Security" area requirements as defined for "single-chip cryptographic modules". Failure of this verification is cause to fail this test.

Reference Documents	DCI-DCSS, 9.5.2.2
----------------------------	-------------------

Sequence	Type
15.3. Integrated IMB Design Review	Pass/Fail
20.3. OMB Design Review	Pass/Fail
21.3. Integrated IMBO Design Review	Pass/Fail

10.4.73. SPB Type 1 Battery Life

- Verify that the Type 1 SPB clock's battery has a life of at least 5 years under normal operating conditions

Reference Documents	DCI-DCSS, 9.4.3.7
----------------------------	-------------------

Sequence	Type
15.3. Integrated IMB Design Review	Pass/Fail
20.3. OMB Design Review	Pass/Fail
21.3. Integrated IMBO Design Review	Pass/Fail

10.4.74. Companion SPB Retrieve Imaging Device Cert

Only applies to a Test Subject that is a Companion SPB (SM).

Verify that the Test Subject retrieves the Imaging Device SPB certificate over the marriage connection.

Reference Documents	DCI-DCSS, 9.4.3.6.5
----------------------------	---------------------

Sequence	Type
15.3. Integrated IMB Design Review	Pass/Fail
21.3. Integrated IMBO Design Review	Pass/Fail

10.4.75. Log Collection for Married MB

Verify that, when integrated within an Imaging Device as a companion SPB, or permanently married to the Imaging Device, the MB provides 24/7 log recording support, and storage of all log records associated with the Imaging Device SPB.

Reference Documents	DCI-DCSS, 9.4.3.6.3
----------------------------	---------------------

Sequence	Type
15.3. Integrated IMB Design Review	Pass/Fail
21.3. Integrated IMBO Design Review	Pass/Fail

10.4.76. Companion SPB Single Purpose Requirement

The following applies only to Test Subjects that are Companion SPBs, i.e. MB designed to operate with an integrated Imaging Device.

Verify that the Test Subject does not operate unless integrated with an Imaging Device SPB. In particular,

- if the Test Subject is a MB, verify that the Test Subject cannot perform any composition decryption function unless integrated within and married to an Imaging Device SPB.

Reference Documents	DCI-DCSS, 9.4.3.6.3
----------------------------	---------------------

Sequence	Type
15.3. Integrated IMB Design Review	Pass/Fail
21.3. Integrated IMBO Design Review	Pass/Fail

10.4.77. Deleted Section

The section "Standalone MB Single Purpose Requirement" was deleted. The section number is maintained here to preserve the numbering of subsequent sections.

10.4.78. Imaging Device SPB Log Reporting Requirements

Verify that the Imaging Device SPB sends log event data across the marriage electrical interface for retention by the companion SPB, as specified in Table 19 of [DCI-DCSS].

Reference Documents	DCI-DCSS, 9.4.3.6.1, 9.4.6.3.8
----------------------------	--------------------------------

Sequence	Type
24.3. SDR Projector Design Review	Pass/Fail
26.3. HDR Direct View Display Design Review	Pass/Fail
27.3. SDR Direct View Display Design Review	Pass/Fail
28.3. HDR Projector Design Review	Pass/Fail

10.4.79. TLS RSA Requirement

The section "TLS RSA Requirement" was deleted. The section number is maintained here to preserve the numbering of subsequent sections.

10.4.80. TLS Authentication of Dual Certificate SM

Only applies if the SM uses dual certificates and the SMS is not permanently integrated.

Verify that the SM presents the SM Certificate (SM Cert) to the SMS when the SMS establishes a TLS session with the SM.

Reference Documents	DCI-DCSS, 9.5.1, 9.5.1.2, 9.4.2.5
----------------------------	-----------------------------------

Sequence	Type
15.3. Integrated IMB Design Review	Pass/Fail

20.3. OMB Design Review	Pass/Fail
21.3. Integrated IMBO Design Review	Pass/Fail

10.4.81. Constrained OMB Processing Capability

Verify that an OMB does *not*:

- Support link encryption;
- Attempt to authenticate other SPBs;
- Attempt to interface or communicate with any other SPB (Imaging Device or other MB), except to accept non-security messaging; and
- Process essence other than the following:
 - Object-Based Audio Essence (OBAE) as defined in Section 3.3 of [DCI-DCSS]; or
 - Auxiliary Data (AD) essence as defined in [SMPTE-429-14], subject to the constraints of Section 9.4.2.7 at [DCI-DCSS].

Reference Documents	DCI-DCSS, 3.3, 9.1, 9.4.3.6.3(5), 9.4.3.6.4, 9.4.2.7 SMPTE-429-14
----------------------------	--

Sequence	Type
20.3. OMB Design Review	Pass/Fail

10.4.82. Export of KDM-Borne Keys

Verify that under no circumstances does the SM export any KDM-borne key from the SM's SPB.

Reference Documents	DCI-DCSS, 9.4.3.5(9d)
----------------------------	-----------------------

Sequence	Type
15.3. Integrated IMB Design Review	Pass/Fail
20.3. OMB Design Review	Pass/Fail
21.3. Integrated IMBO Design Review	Pass/Fail

10.4.83. Deleted Section

The section "Encrypted Auxiliary Data Processing" was deleted. The section number is maintained here to preserve the numbering of subsequent sections.

10.4.84. Deleted Section

The section "OBAE Addendum" was deleted. The section number is maintained here to preserve the numbering of subsequent sections.

10.4.85. OBAE FM Robustness

- Verify that forensic marking applied to OBAE essence resists/survives multiple D/A and A/D conversions, radio frequency or infrared transmissions within the theater, any combination and down conversion of captured channels,

resampling of channels, time compression/expansion with pitch shift and pitch preserved, linear speed changes within 10% and pitch-invariant time scaling within 4%.

- Verify that forensic marking applied to OBAE essence resists/survives data reduction coding, nonlinear amplitude compression, additive or multiplicative noise frequency response distortion such as equalization, addition of echo, band-pass filtering, flutter and wow and overdubbing.

Reference Documents	DCI-DCSS, 9.4.6.1.3
----------------------------	---------------------

Sequence	Type
20.3. OMB Design Review	Pass/Fail
21.3. Integrated IMBO Design Review	Pass/Fail

10.4.86. OBAE FM Inaudibility

Verify that forensic marking applied to OBAE essence is inaudible in critical listening A/B tests.

Reference Documents	DCI-DCSS, 9.4.6.1.3
----------------------------	---------------------

Sequence	Type
20.3. OMB Design Review	Pass/Fail
21.3. Integrated IMBO Design Review	Pass/Fail

10.5. DCI Requirements for Imaging Devices

Each of the subsections below describes a DCI requirement that shall be verified by examining the manufacturer's documentation.

10.5.1. Pixel Visibility (Direct View Display)

Verify, according to the following steps, that the display pixel density of the imaging device is equal to or greater than 60 display pixels per degree when viewed at 1.6 screen heights:

1. Based on manufacturer's information, determine the number of display pixels R_h of the imaging device in the vertical direction when displaying the 4096x2160 DCI container. The term display pixel is defined at [DV-ADD].
2. Compute the pixel density at viewing distance of 1.6 screen heights $P_{1.6}$ according to the equation

$$P_{1.6} = 1 / \arctan(1 / (1.6 \cdot R_h))$$
 where $\arctan()$ is the inverse-tangent function that returns units of degrees, i.e. $\arctan(1) = 45$ degrees.
3. A value $P_{1.6}$ smaller than 60 display pixels per degree is cause to fail this test.

Note: The nominal average human vision performance called 20/20 vision corresponds to the ability to resolve 30 cycles per degree. On an imaging device the minimum pixel density that can show 30 cycles per degree is 60 pixels per degree.

Reference Documents	[DV-ADD]
----------------------------	----------

Sequence	Type
26.3. HDR Direct View Display Design Review	Pass/Fail

PART III. CONSOLIDATED TEST PROCEDURES

The chapters in this part contain Test Sequences and a standardized Test Report for testing Digital Cinema equipment. Each Test Sequence subjects a Test Subject to a set of Tests selected from Part I. Procedural Tests and Part II. Design Evaluation Guidelines.

The Test Subject is specified at the opening of each Test Sequence chapter and at Table 11.2. Each Test Subject comprises a single *certificated device*.

Chapter 11. Testing Policy and Reporting

11.1. Test Reports

A Test Report consists of information about a Test Session recorded as specified in Table 11.1. All fields shall be filled in.

Each certificated device listed on line 9 of a Test Report, with the exception of an SMS, shall be a DCI compliant certificated device as defined below.

Note: NOTE 1: Certificated devices listed on line 9 of a Test Report might have achieved DCI compliance against different versions of the CTP.

Note: EXAMPLE 1: An IMB that achieved DCI-compliance per CTP 1.3 can be used when performing Chapter 24. SDR Projector Consolidated Test Sequence in this version of the CTP.

For a permanently married Imaging Device, line 9 of a Test Report shall identify the Imaging Device and companion device (per [DCI-DCSS], Section 9.4.3.6.6).

For an integrated SMS, line 9 of a Test Report shall identify the SMS and IMB (per [DCI-DCSS], Section 9.4.2.5, first bullet).

To assure clarity, line 9 of a Test Report shall include the text "permanently married" or "permanently integrated" as applicable.

Table 11.1. Test Session Data

1. Reporting date	
2. Test Start Date	
3. CTP version	
4. Name of Testing Organization	
5. Address of Testing Organization	
6. Name of Test Operator	
7. Test location (if not at Testing Organization's site)	
8. Name of Test Subject Representative	
9. Address of Test Subject Representative	
10. Make and model of Test Subject (to be included on the DCI listing hot link)	
11. Serial and model numbers identifying each of the participating certificated devices, including software and/or firmware version numbers as applicable.	
12. Test sequence performed (select one)	<input type="checkbox"/> Chapter 15. Integrated IMB Consolidated Test Sequence <input type="checkbox"/> Chapter 20. OMB Consolidated Test Sequence <input type="checkbox"/> Chapter 21. Integrated IMBO Consolidated Test Sequence <input type="checkbox"/> Chapter 24. SDR Projector Consolidated Test Sequence <input type="checkbox"/> Chapter 26. HDR Direct View Display Consolidated Test Sequence <input type="checkbox"/> Chapter 27. SDR Direct View Display Consolidated Test Sequence <input type="checkbox"/> Chapter 28. HDR Projector Consolidated Test Sequence
13. Test status (select one)	<input type="checkbox"/> Pass <input type="checkbox"/> Fail
14. Sequences performed (select one)	<input type="checkbox"/> Test Sequence and Design Review <input type="checkbox"/> Confidence Sequence (Confidence Retest)

A Test Session is the collection of Test Results gathered by subjecting a set of certificated devices to one of the Test Sequences listed in [Table 11.2](#), with the set of certificated devices including at least those required by the Test Sequence. A certificated device is defined by the combination of its manufacturer, product name and model/version number.

Note: NOTE 2: the set of certificated devices used for a Test Session cannot change, e.g., the same IMB is used for all tests specified in a Test Session against [Chapter 24. SDR Projector Consolidated Test Sequence](#).

Note: NOTE 3: two IMBs with different model/version number are not the same IMB when creating a Test Session.

Table 11.2. Test Sequences

Test sequence	Test subject	Certificated device that comprise the Test subject	Certificated devices required to perform the Test Sequence
Chapter 15. Integrated IMB Consolidated Test Sequence	Integrated IMB	IMB	Imaging Device, IMB, SMS
Chapter 20. OMB Consolidated Test Sequence	Outboard Media Block	OMB	Imaging Device, OMB, IMB, SMS
Chapter 21. Integrated IMBO Consolidated Test Sequence	Integrated IMBO	IMBO	Imaging Device, IMBO, SMS

<u>Chapter 24. SDR Projector Consolidated Test Sequence</u>	Projector	Projector	Projector, IMB or IMBO, SMS
<u>Chapter 26. HDR Direct View Display Consolidated Test Sequence</u>	Direct View Display	Direct View Display	Direct View Display, IMB or IMBO, SMS
<u>Chapter 27. SDR Direct View Display Consolidated Test Sequence</u>	Direct View Display	Direct View Display	Direct View Display, IMB or IMBO, SMS
<u>Chapter 28. HDR Projector Consolidated Test Sequence</u>	Projector	Projector	Projector, IMB or IMBO, SMS

A Test Result is the outcome of evaluating a set of certificated devices against the steps and requirements of a single Test specified in this version of the CTP. Each Test specifies the type of test result generated, either PASS, FAIL or measured data.

A Test Result may, at the discretion of the Testing Organization, be reused across multiple Test Sessions, and thus different Test Sequences, if and only if (a) the underlying test is identical and (b) the set of certificated devices subjected to the Test are identical. The Testing Organization is required to attest that both conditions (a) and (b) are met.

Note: NOTE 4: The above constraints require the supplier(s) of each certificated device to present to the Testing Organization the Test Results to be reused.

EXAMPLE 2: the Test Result obtained by subjecting an SMS to 8.1.1. Storage System Ingest Interface in the course of performing a Test Session against Chapter 15. Integrated IMB Consolidated Test Sequence can be reused when subjecting the same SMS (as defined by its manufacturer, product name and model/version number) to the same test procedure in the course of performing a Test Session against Chapter 21. Integrated IMBO Consolidated Test Sequence.

EXAMPLE 3: the Test Result obtained by subjecting an IMB to 5.1.1. SPB Digital Certificate as specified in CTP 1.2.1 cannot be reused when subjecting the same IMB against the same test procedure in this version of CTP since 5.1.1. SPB Digital Certificate is not identical in both versions of the CTP.

The status of the Test Session is PASS if none of the test results is FAIL; the status of the Test Session is FAIL otherwise.

The certificated device that comprises a Test Subject of a Test Session whose status is PASS is a “DCI compliant certificated device”.

Note: NOTE 5: A “DCI compliant certificated device” is defined in the context of a specific Test Session, i.e., for a particular set of certificated devices and set of tests defined in a specific version of the CTP. As such, while the certificated device remains DCI-compliant in perpetuity within that context, not all Test Results associated with the DCI compliant certificated device can necessarily be reused in all future Test Sessions in which the certificated device is involved, as described in this section.

11.2. Testing Policy

11.2.1. Definitions

Non-Programmable Related Components (NPRC)

Any non-programmable devices that do not affect compliance of the current DCSS, e.g., nonprogrammable integrated circuits, resistors, capacitors, transistors, inductors, lamps, fans, displays, power supplies, switches, connectors, fuses, passive components, mechanical components, etc.

11.2.2. Combining Devices into Families

An entity may aggregate some of its products that only have different NPRCs into a family group by attesting to the similarity of that family group in a letter, signed by a person who has authority to bind the entity under test to the terms of said letter. The letter shall be sent to the contracted licensed test entity and to DCI at dcinfo@dcimovies.com.

The letter, which will be attached to the detailed report of the tested device, will clearly and comprehensively provide detailed information and justification as described below:

- Clear justification for combining various products into a family group.

- Itemized model number and description of the product tested and each of the products proposed to be in the same family group.
- Clear itemized differences between each product model in a proposed family group.
- Attest that all SPB-1 electrical, mechanical, and data-protocol interfaces and behavior are identical among all models of the proposed family group.
- Attest that all implementations of SPB-2 normative device requirements are identical among all models of the proposed family group.

Further, the form specified in Table 11.3 shall be attached to the letter to identify the general family group information. This form will be published with the summary report of the tested device on the DCI Compliant Family Groups web site page.

Table 11.3. General family group information

Manufacturer		
Testament Submission Date		
Equipment Tested		
Family Item 0	Make	
	Model	
	Version	
Family Item 1	Make	
	Model	
	Version	
Family Item 2	Make	
	Model	
	Version	
(add items as needed)		
Printed Name		
Job Title		
Signature		

11.2.3. Equipment Component Failures during Testing

11.2.3.1. Failures within the Test Subject

If any NPRCs fail within a Test Subject during CTP testing, the components may be replaced with *equivalent* units (having identical technical specifications) and testing resumed from a test point before any anomalous behavior was first observed. In order to assure compliance, the DCI licensed entity will determine the appropriate resumption point and continue testing all procedures thereafter in numerical order.

If any programmable components (e.g., FPGAs) fail within a Test Subject during CTP testing and it can be shown rigorously by the manufacturer that a completely identical component with identical programming is available (same component, version and programming), the programmable component may be replaced with the identical component and testing resumed from a test point before any anomalous behavior was first observed. In order to assure compliance, the DCI licensed entity will determine the appropriate resumption point and continue testing all procedures thereafter in numerical order.

It is recognized that when an SPB-1 or SPB-2 is replaced, the private key will necessarily change. However, the certificate formulation (e.g., digest method, subject name component values (O, OU), subject name CN roles, RSA, key length, extensions, etc.) will need to be identical to that of the certificate in the original SPB so as to result in the same system behavior.

11.2.3.2. Failures of Devices Connected to the Test Subject

Any device that fails during CTP testing that is connected to the Test Subject may be repaired and then verified as to its correct behavior. If correct behavior is verified, testing may resume from a test point before any anomalous behavior was first observed.

11.2.4. Changes to Previously DCI CTP Compliant Devices

11.2.4.1. General

Once compliance has been established for a particular device model per this specification, all product changes shall maintain compliance with the [DCI-DCSS] and this specification. Product changes may require retesting to ensure continued compliance. For the avoidance of doubt, no retesting is required if there are no product changes.

11.2.4.2. SPB Type 1 (SPB-1) Devices

Changes of any kind may require retesting of the SPB-1 device for FIPS 140 compliance by a Cryptographic Module Validation Program (CMVP) testing laboratory. The extent of retesting of FIPS compliance shall be at the determination of the CMVP testing laboratory. Device manufacturers shall notify DCI at dcinfo@dcimovies.com of all SPB-1 upgrades prior to deployment, identifying all relevant component version numbers.

11.2.4.3. NPRC

Replacing NPRCs with technically equivalent components will not require retesting.

11.2.4.4. Software/Firmware and Confidence Retesting

All changes to software and firmware shall maintain compliance with the [DCI-DCSS] and this specification. Device manufacturers shall notify DCI at dcinfo@dcimovies.com of all upgrades prior to deployment, identifying all relevant component version numbers.

Changes to software or firmware shall require Confidence Retesting by a licensed DCI test entity on a “three-year or four-year upgrade cycle” if either

- a. one, two or three upgrades are deployed within three years of the CTP compliance date, the device shall undergo a Confidence Retest prior to its third-year anniversary date; or
- b. a fourth upgrade is intended to be deployed within three years of the CTP compliance date, the device shall undergo a Confidence Retest with the cumulative changes of all four upgrades installed prior to the deployment of that fourth upgrade.

Any Confidence Retest of updated software or firmware shall be conducted against the version of this specification in force as of the date the device is submitted for Confidence Retest, subject to the following exceptions.

To minimize barriers to upgrades, SPB devices that are *already listed* on the Compliant Equipment page of the DCI website may be excused from CTP tests associated with the bullets below for purposes of a Confidence Retest:

- Dual Media Block digital certificate requirements of [DCI-DCSS], Section 9.5.1, which were changed by DCI-DCSS-ERR-20110420.

- Secure silicon integrated circuit requirements of [DCI-DCSS], Section 9.5.2.2, which were changed by [DCI-DCSS-ERR-20160830].
- Self-generated RSA key pair establishment per [DCI-DCSS], Section 9.5.1, which was changed by [DCI-DCSS-ERR-20160428].
- Evolving NIST/FIPS requirements for SP800-90B and SP800-56Br2 compliance, per the [DCI-NIST-NOTE].

Confidence Retests have been selected to assure that software/firmware changes have not impacted critical security functionality. Hardware, integrated circuit, FIPS related issues, etc., are addressed by Sections 11.2.4.2. SPB Type 1 (SPB-1) Devices and 11.2.4.3. NPRC.

Chapter 12. Deleted Chapter

The chapter "Digital Cinema Package (DCP) Consolidated Test Sequence" was deleted. The chapter number is maintained here to preserve the numbering of subsequent sections.

Chapter 13. Deleted Chapter

The chapter "Digital Cinema Server Consolidated Test Sequence" was deleted. The chapter number is maintained here to preserve the numbering of subsequent sections.

Chapter 14. Deleted Chapter

The chapter "Standalone D-Cinema Projector Consolidated Test Sequence" was deleted. The chapter number is maintained here to preserve the numbering of subsequent sections.

Chapter 15. Integrated IMB Consolidated Test Sequence

15.1. Overview

The test sequence defined in this chapter is intended to be used to test a integrated Image Media Block (IMB) as the Test Subject. The configuration and architecture of the system may vary, but the test sequence requires that the system consists of at least a light processing system including electronic and optical components (Projector), an Image Media Block (containing a Security Manager, Media Decryptor, etc.), and a Screen Management Server (SMS). For the purpose of this test, the Test Operator may substitute a Theater Management Server (TMS) for the SMS if it implements the required functionality. Wherever a test procedure refers to an SMS, the equivalent TMS may also be used.

For the purpose of compliance testing as defined in this Chapter, the spatial resolution of the projector shall be no less than that of the Media Block.

Before performing the test sequence provided below, the Test Operator should read and understand the documentation provided with the Test Subject. If adequate documentation is not available, a Test Subject Representative should be available to provide assistance during the test session.

15.2. Integrated IMB Test Sequence

For each row of the table below, perform the procedure specified in the Procedure column, subject to all conditions specified in the Condition column. Indicate the status of the test in the Pass or Fail column, unless the test is specified as *data only*. Any marks in greyed-out fields indicate a test failure. Report any information listed in the Measured Data column. The Test Operator may record any additional observations.

Step	Procedure	Pass	Fail	Measured data
1	<u>3.5.1. KDM NonCriticalExtensions Element</u>			
2	<u>3.5.2. ETM IssueDate Field Check</u>			
3	<u>3.5.4. Structure ID Check</u>			
4	<u>3.5.5. Certificate Thumbprint Check</u>			
5	<u>3.5.7. KeyInfo Field Check</u>			
6	<u>3.5.8. KDM Malformations</u>			
7	<u>3.5.9. KDM Signature</u>			
8	<u>5.1.1. SPB Digital Certificate</u>			
9	<u>5.3.2.1. Log Structure</u>			
10	<u>5.3.2.3. Log Sequence Numbers</u>			
11	<u>5.3.2.6. Log Report Signature Validity</u>			
12	<u>5.4.1.1. FrameSequencePlayed Event</u>			
13	<u>5.4.1.2. CPLStart Event</u>			
14	<u>5.4.1.3. CPLEnd Event</u>			
15	<u>5.4.1.4. PlayoutComplete Event</u>			
16	<u>5.4.1.5. CPLCheck Event</u>			
17	<u>5.4.1.6. KDMKeysReceived Event</u>			
18	<u>5.4.1.7. KDMDeleted Event</u>			
19	<u>5.4.2.6. SPBStartup and SPBShutdown Events</u>			
20	<u>5.4.2.7. SPBOpen and SPBClose Events</u>			
21	<u>5.4.2.8. SPBClockAdjust Event</u>			
22	<u>5.4.2.9. SPBMarriage and SPBDivorce Events</u>			
23	<u>5.4.2.10. SPBSoftware Event</u>			
24	<u>5.4.2.11. SPBSecurityAlert Event</u>	(data only)		
25	<u>6.1.1. Image Integrity Checking</u>			
26	<u>6.1.2. Sound Integrity Checking</u>			
27	<u>6.1.4. Restriction of Keying to MD Type</u>			
28	<u>6.1.5. Restriction of Keying to Valid CPLs</u>			
29	<u>6.1.8. Content Key Extension, End of Engagement</u>			
30	<u>6.1.9. ContentAuthenticator Element Check</u>			
31	<u>6.1.10. KDM Date Check</u>			
32	<u>6.1.11. KDM TDL Check</u>			
33	<u>6.1.12. Maximum Number of DCP Keys</u>			
34	<u>6.1.13. CPL Id Check</u>			
35	<u>6.1.15. Restriction of Playback in Absence of Integrity Pack Metadata</u>			
36	<u>6.1.19. Plurality of Media Block Identity Certificates</u>			
37	<u>6.1.20. Validity of SPB Certificates</u>			

38	<u>6.3.1. Clock Adjustment</u>			
39	<u>6.3.2. SPB Type 1 Clock Battery</u>			
40	<u>6.3.3. Clock Resolution</u>			
41	<u>6.4.1. FM Application Constraints</u>			
42	<u>6.4.2. Granularity of FM Control</u>			
43	<u>6.4.3. FM Payload</u>			
44	<u>6.4.4. FM Audio Bypass</u>			
45	<u>6.4.5. Selective Audio FM Control</u>			
46	<u>6.5.1. Playback of Image Only Material</u>			
47	<u>6.5.2. Decoder Requirements</u>			
48	<u>6.6.1. Digital Audio Interfaces</u>			
49	<u>6.6.2. Audio Sample Rate Conversion</u>			
50	<u>6.6.3. Audio Delay Setup</u>			
51	<u>6.6.4. Click Free Splicing of Audio Track Files</u>			
52	<u>6.7.1. Media Block Overlay</u>			
53	<u>6.7.4. Default Timed Text Font</u>			
54	<u>6.7.6. Timed Text Decryption</u>			
55	<u>7.3.2. Companion SPBs with Electronic Marriage</u>			
56	<u>7.3.3. Companion SPB Marriage Break Key Retaining</u>			
57	<u>8.1.3. Storage System Redundancy</u>			
58	<u>8.1.4. Storage System Performance</u>			
59	<u>8.2.2. Show Playlist Creation</u>		(data only)	
60	<u>8.2.3. Show Playlist Format</u>			
61	<u>8.2.5. Automation Control and Interfaces</u>			
62	<u>8.2.6. Interrupt Free Playback</u>			
63	<u>8.2.7. Artifact Free Transition of Image Format</u>			
64	<u>8.2.8. Restarting Playback</u>			
65	<u>8.2.9. SMS User Accounts</u>			
66	<u>8.2.10. SMS Operator Identification</u>			
67	<u>8.2.11. SMS Identity and Certificate</u>			
68	<u>8.2.12. Content Keys and TDL check</u>			
69	<u>8.2.14. KDM Content Keys Check</u>			
70	<u>8.2.15. Validity of SMS Certificates</u>			

15.3. Integrated IMB Design Review

For each requirement listed in the table below, prove that the system design meets the requirement by identifying the software or hardware mechanism that implements the requirement and analyzing the design to assure that the requirement has been met, subject to stipulated conditions. If a proof cannot be made, the design will be considered non-compliant with regard to the requirement. To perform this analysis the examiner will require access to exhibit documents (system design artifacts) such as

schematic diagrams, implementation source code, unit test source code, state diagrams, design notes, etc. See [Chapter 9: FIPS Requirements for a Type 1 SPB](#) and [Chapter 10: DCI Requirements Review](#) for more information.

For each requirement, the examiner must record the identifiers of the exhibits consulted in proving the requirement, including applicable version identifiers, section or sheet numbers, grid identifiers, etc., and the examiner must record *Pass* or *Fail* to indicate whether or not the requirement has been met by the design. The examiner may also record any notes relevant to interpreting the exhibits and to the determination of the compliance status.

Step	Procedure	Pass	Fail	Exhibit Identifiers
1	9.5.1. SM Operating Environment			
2	9.5.3. SPB Type 1 Tamper Responsiveness			
3	9.5.6. SPB Type 1 FIPS Requirements			
4	9.5.8. Asymmetric Key Generation			
5	9.5.9. Critical Security Parameter Protection			
6	9.5.11. Degraded mode(s) of operation prohibited			
7	9.5.12. Control output inhibition			
8	9.5.13. Maintenance role/interface prohibited			
9	9.5.14. Self-initiated cryptographic output capability			
10	9.5.15. Self-initiated cryptographic output capability			
11	9.5.16. Periodic self-tests			
12	10.4.1. Theater System Reliability			
13	10.4.2. Theater System Storage Security			
14	10.4.4. Security Entity Physical Protection			
15	10.4.5. Secure SMS-SM Communication			
16	10.4.6. Location of Security Manager			
17	10.4.16. KDM Purge upon Expiry			
18	10.4.22. Clock Date-Time-Range			
19	10.4.23. Clock Setup			
20	10.4.24. Clock Stability			
21	10.4.25. Repair and Renewal of SPBs			
22	10.4.27. Clock Continuity			
23	10.4.42. FM Algorithm General Requirements			
24	10.4.43. FM Insertion Requirements			
25	10.4.44. IFM Visual Transparency			
26	10.4.45. IFM Robustness			
27	10.4.46. AFM Inaudibility			
28	10.4.47. AFM Robustness			
29	10.4.48. FM Control Instance			
30	10.4.51. SPB Log Storage Requirements			
31	10.4.53. MB Log Storage Capabilities			
32	10.4.56. SPB Log Failure			
33	10.4.57. Log Purging in Failed SPBs			

34	<u>10.4.58. MB Tasks</u>			
35	<u>10.4.59. Type 1 SPB RSA Private Keys</u>			
36	<u>10.4.60. Content Keys Outside Secure Silicon</u>			
37	<u>10.4.61. Prohibition of SPB Type 1 Field Serviceability</u>			
38	<u>10.4.62. Use of Software Protection Methods</u>			
39	<u>10.4.63. TMS Role</u>			
40	<u>10.4.64. D-Cinema Security Parameter Protection</u>			
41	<u>10.4.65. RSA Key Entropy</u>			
42	<u>10.4.66. Preloaded Symmetric Key Entropy</u>			
43	<u>10.4.67. Media Block Caching of Keys</u>			
44	<u>10.4.68. SPB Type 1 Firmware Modifications</u>			
45	<u>10.4.69. SPB Type 1 Log Retention</u>			
46	<u>10.4.72. SPB Secure Silicon Requirements</u>			
47	<u>10.4.73. SPB Type 1 Battery Life</u>			
48	<u>10.4.74. Companion SPB Retrieve Imaging Device Cert</u>			
49	<u>10.4.75. Log Collection for Married MB</u>			
50	<u>10.4.76. Companion SPB Single Purpose Requirement</u>			
51	<u>10.4.80. TLS Authentication of Dual Certificate SM</u>			
52	<u>10.4.82. Export of KDM-Borne Keys</u>			

15.4. Integrated IMB Confidence Sequence

For each row of the table below, perform the procedure specified in the Procedure column, subject to all conditions specified in the Condition column. Indicate the status of the test in the Pass or Fail column, unless the test is specified as *data only*. Any marks in greyed-out fields indicate a test failure. Report any information listed in the Measured Data column. The Test Operator may record any additional observations.

Step	Procedure	Pass	Fail	Measured data
1	<u>5.1.1. SPB Digital Certificate</u>			
2	<u>5.4.1.6. KDMKeysReceived Event</u>			
3	<u>5.4.2.10. SPBSoftware Event</u>			
4	<u>6.1.5. Restriction of Keying to Valid CPLs</u>			
5	<u>6.1.8. Content Key Extension, End of Engagement</u>			
6	<u>6.1.9. ContentAuthenticator Element Check</u>			
7	<u>6.1.11. KDM TDL Check</u>			
8	<u>6.1.20. Validity of SPB Certificates</u>			
9	<u>6.3.1. Clock Adjustment</u>			
10	<u>6.4.3. FM Payload</u>			
11	<u>7.3.2. Companion SPBs with Electronic Marriage</u>			
12	<u>7.3.3. Companion SPB Marriage Break Key Retaining</u>			
13	<u>8.2.7. Artifact Free Transition of Image Format</u>			
14	<u>8.2.11. SMS Identity and Certificate</u>			

15	8.2.12. Content Keys and TDL check			
16	8.2.15. Validity of SMS Certificates			

Chapter 16. Deleted Chapter

The chapter "Link Decryptor/Encryptor Consolidated Test Sequence" was deleted. The chapter number is maintained here to preserve the numbering of subsequent sections.

Chapter 17. Deleted Chapter

The chapter "Digital Cinema Server Consolidated Confidence Sequence" was deleted. The chapter number is maintained here to preserve the numbering of subsequent sections.

Chapter 18. Deleted Chapter

The chapter "Standalone D-Cinema Projector Consolidated Test Sequence" was deleted. The chapter number is maintained here to preserve the numbering of subsequent sections.

Chapter 19. Deleted Chapter

The chapter "Integrated IMB Consolidated Confidence Sequence" was moved to [15.4. Integrated IMB Confidence Sequence](#). The chapter number is maintained here to preserve the numbering of subsequent sections.

Chapter 20. OMB Consolidated Test Sequence

20.1. Overview

The test sequence defined in this chapter is intended to be used to test an Outboard Media Block (OMB) as the Test Subject. The configuration and architecture of the system may vary, but the test sequence requires that the system consists of at least an OMB, Projector, IMB and SMS. For the purpose of this test, the Test Operator may substitute a Theater Management Server/System (TMS) for the SMS if it implements the required functionality. Wherever a test procedure refers to an SMS, the equivalent TMS may also be used.

Digital cinema systems that include an OMB operate in Multiple Media Block (MMB) mode, wherein the SMS is responsible for managing playout processes of the OMB and IMB, and the IMB provides synchronization to the OMB. The IMB must also be able to play only a portion of the total content in a composition, as the OMB will be handling some of the content. Thus, the IMB and SMS must be "MMB Capable" to function within a MMB architecture. This Chapter contains specific tests for the IMB and SMS to test for this capability.

Before performing the test sequence provided below, the Test Operator should read and understand the documentation provided with the Test Subject. If adequate documentation is not available, a Test Subject Representative should be available to provide assistance during the test session.

20.2. OMB Test Sequence

For each row of the table below, perform the procedure specified in the Procedure column, subject to all conditions specified in the Condition column. Indicate the status of the test in the Pass or Fail column, unless the test is specified as *data only*. Any marks in greyed-out fields indicate a test failure. Report any information listed in the Measured Data column. The Test Operator may record any additional observations.

Step	Procedure	Pass	Fail	Measured data
------	-----------	------	------	---------------

1	3.5.10. KDM NonCriticalExtensions Element (OBAE)			
2	3.5.11. ETM IssueDate Field Check (OBAE)			
3	3.5.12. Structure ID Check (OBAE)			
4	3.5.13. Certificate Thumbprint Check (OBAE)			
5	3.5.14. KeyInfo Field Check (OBAE)			
6	3.5.15. KDM Malformations (OBAE)			
7	3.5.16. KDM Signature (OBAE)			
8	5.1.1. SPB Digital Certificate			
9	5.3.2.1. Log Structure			
10	5.3.2.7. Log Sequence Numbers (OBAE)			
11	5.3.2.8. Log Report Signature Validity (OBAE)			
12	5.4.1.8. FrameSequencePlayed Event (OBAE)			
13	5.4.1.9. CPLStart Event (OBAE)			
14	5.4.1.10. CPLEnd Event (OBAE)			
15	5.4.1.11. PayoutComplete Event (OBAE)			
16	5.4.1.12. CPLCheck Event (OBAE)			
17	5.4.1.13. KDMKeysReceived Event (OBAE)			
18	5.4.1.14. KDMDeleted Event (OBAE)			
19	5.4.2.6. SPBStartup and SPBShutdown Events			
20	5.4.2.8. SPBClockAdjust Event			
21	5.4.2.10. SPBSoftware Event			
22	5.4.2.11. SPBSecurityAlert Event		(data only)	
23	6.1.14. CPL Id Check (OBAE)			
24	6.1.15. Restriction of Playback in Absence of Integrity Pack Metadata			
25	6.1.16. Restriction of Keying to MDEK Type (OBAE)			
26	6.1.17. OBAE Integrity Checking			
27	6.1.18. Content Key Extension, End of Engagement (OBAE)			
28	6.1.19. Plurality of Media Block Identity Certificates			
29	6.1.20. Validity of SPB Certificates			
30	6.1.21. Maximum Number of DCP Keys (OBAE)			
31	6.1.22. Restriction of Keying to Valid CPLs (OBAE)			
32	6.1.23. ContentAuthenticator Element Check (OBAE)			
33	6.1.24. KDM Date Check (OBAE)			
34	6.3.1. Clock Adjustment			
35	6.3.2. SPB Type 1 Clock Battery			
36	6.3.4. Clock Resolution (OMB)			
37	6.3.5. Clock Adjustment (OMB)			

38	<u>6.4.6. FM Application Constraints (OBAE)</u>			
39	<u>6.4.7. Granularity of FM Control (OBAE)</u>			
40	<u>6.4.8. FM Payload (OBAE)</u>			
41	<u>6.4.9. FM Audio Bypass (OBAE)</u>			
42	<u>6.5.1. Playback of Image Only Material</u>			
43	<u>6.8.1. Click Free Splicing of OBAE Track Files</u>			
44	<u>6.8.2. OBAE Delay Setup</u>			
45	<u>6.8.3. Maximum Bitrate OBAE</u>			
46	<u>6.8.4. OBAE Rendering Expectations</u>			
47	<u>8.1.6. Storage System Performance (OBAE)</u>			
48	<u>8.2.13. Content Keys and TDL check (OBAE)</u>			
49	<u>8.2.14. KDM Content Keys Check</u>			
50	<u>8.2.16. Interrupt Free Playback (OBAE)</u>			
51	<u>8.2.17. Restarting Playback (OBAE)</u>			
52	<u>8.2.18. Show Playlist Creation (OBAE)</u>		(data only)	
53	<u>8.2.20. SMS Operator Identification (OBAE)</u>			

20.3. OMB Design Review

For each requirement listed in the table below, prove that the system design meets the requirement by identifying the software or hardware mechanism that implements the requirement and analyzing the design to assure that the requirement has been met, subject to stipulated conditions. If a proof cannot be made, the design will be considered non-compliant with regard to the requirement. To perform this analysis the examiner will require access to exhibit documents (system design artifacts) such as schematic diagrams, implementation source code, unit test source code, state diagrams, design notes, etc. See [Chapter 9: FIPS Requirements for a Type 1 SPB](#) and [Chapter 10: DCI Requirements Review](#) for more information.

For each requirement, the examiner must record the identifiers of the exhibits consulted in proving the requirement, including applicable version identifiers, section or sheet numbers, grid identifiers, etc., and the examiner must record Pass or Fail to indicate whether or not the requirement has been met by the design. The examiner may also record any notes relevant to interpreting the exhibits and to the determination of the compliance status

Step	Procedure	Pass	Fail	Exhibit Identifiers
1	<u>9.5.1. SM Operating Environment</u>			
2	<u>9.5.3. SPB Type 1 Tamper Responsiveness</u>			
3	<u>9.5.6. SPB Type 1 FIPS Requirements</u>			
4	<u>9.5.8. Asymmetric Key Generation</u>			
5	<u>9.5.9. Critical Security Parameter Protection</u>			
6	<u>9.5.11. Degraded mode(s) of operation prohibited</u>			
7	<u>9.5.12. Control output inhibition</u>			
8	<u>9.5.13. Maintenance role/interface prohibited</u>			
9	<u>9.5.14. Self-initiated cryptographic output capability</u>			
10	<u>9.5.15. Self-initiated cryptographic output capability</u>			
11	<u>9.5.16. Periodic self-tests</u>			
12	<u>10.4.1. Theater System Reliability</u>			

13	<u>10.4.2. Theater System Storage Security</u>			
14	<u>10.4.4. Security Entity Physical Protection</u>			
15	<u>10.4.5. Secure SMS-SM Communication</u>			
16	<u>10.4.6. Location of Security Manager</u>			
17	<u>10.4.16. KDM Purge upon Expiry</u>			
18	<u>10.4.22. Clock Date-Time-Range</u>			
19	<u>10.4.23. Clock Setup</u>			
20	<u>10.4.24. Clock Stability</u>			
21	<u>10.4.25. Repair and Renewal of SPBs</u>			
22	<u>10.4.27. Clock Continuity</u>			
23	<u>10.4.42. FM Algorithm General Requirements</u>			
24	<u>10.4.43. FM Insertion Requirements</u>			
25	<u>10.4.48. FM Control Instance</u>			
26	<u>10.4.51. SPB Log Storage Requirements</u>			
27	<u>10.4.53. MB Log Storage Capabilities</u>			
28	<u>10.4.56. SPB Log Failure</u>			
29	<u>10.4.57. Log Purging in Failed SPBs</u>			
30	<u>10.4.58. MB Tasks</u>			
31	<u>10.4.59. Type 1 SPB RSA Private Keys</u>			
32	<u>10.4.60. Content Keys Outside Secure Silicon</u>			
33	<u>10.4.61. Prohibition of SPB Type 1 Field Serviceability</u>			
34	<u>10.4.62. Use of Software Protection Methods</u>			
35	<u>10.4.63. TMS Role</u>			
36	<u>10.4.64. D-Cinema Security Parameter Protection</u>			
37	<u>10.4.65. RSA Key Entropy</u>			
38	<u>10.4.66. Preloaded Symmetric Key Entropy</u>			
39	<u>10.4.67. Media Block Caching of Keys</u>			
40	<u>10.4.68. SPB Type 1 Firmware Modifications</u>			
41	<u>10.4.69. SPB Type 1 Log Retention</u>			
42	<u>10.4.72. SPB Secure Silicon Requirements</u>			
43	<u>10.4.73. SPB Type 1 Battery Life</u>			
44	<u>10.4.80. TLS Authentication of Dual Certificate SM</u>			
45	<u>10.4.81. Constrained OMB Processing Capability</u>			
46	<u>10.4.82. Export of KDM-Borne Keys</u>			
47	<u>10.4.85. OBAE FM Robustness</u>			
48	<u>10.4.86. OBAE FM Inaudibility</u>			

20.4. OMB Confidence Sequence

For each row of the table below, perform the procedure specified in the Procedure column, subject to all conditions specified in the Condition column. Indicate the status of the test in the Pass or Fail column, unless the test is specified as *data only*. Any marks in greyed-out fields indicate a test failure. Report any information listed in the Measured Data column. The Test Operator may record any additional observations.

Step	Procedure	Pass	Fail	Measured data
1	<u>5.1.1. SPB Digital Certificate</u>			
2	<u>5.4.1.13. KDMKeysReceived Event (OBAE)</u>			
3	<u>5.4.2.10. SPBSoftware Event</u>			
4	<u>6.1.18. Content Key Extension, End of Engagement (OBAE)</u>			
5	<u>6.1.20. Validity of SPB Certificates</u>			
6	<u>6.1.20. Validity of SPB Certificates</u>			
7	<u>6.1.22. Restriction of Keying to Valid CPLs (OBAE)</u>			
8	<u>6.1.23. ContentAuthenticator Element Check (OBAE)</u>			
9	<u>6.3.5. Clock Adjustment (OMB)</u>			
10	<u>6.4.8. FM Payload (OBAE)</u>			
11	<u>8.2.13. Content Keys and TDL check (OBAE)</u>			

Chapter 21. Integrated IMBO Consolidated Test Sequence

21.1. Overview

The test sequence defined in this chapter is intended to be used to test an integrated Image Media Block with OMB functions (IMBO) as the Test Subject. The configuration and architecture of the system may vary, but the test sequence requires that the system consists of at least a light processing system including electronic and optical components (Projector), an IMBO (containing a Security Manager, Media Decryptors, image, main sound and OBAE sound processing, etc.), and a Screen Management Server/System (SMS). For the purpose of this test, the Test Operator may substitute a Theater Management Server/System (TMS) for the SMS if it implements the required functionality. Wherever a test procedure refers to an SMS, the equivalent TMS may also be used.

For the purpose of compliance testing as defined in this Chapter, the spatial resolution of the projector shall be no less than that of the Media Block.

Before performing the test sequence provided below, the Test Operator should read and understand the documentation provided with the Test Subject. If adequate documentation is not available, a Test Subject Representative should be available to provide assistance during the test session.

21.2. Integrated IMBO Test Sequence

For each row of the table below, perform the procedure specified in the Procedure column, subject to all conditions specified in the Condition column. Indicate the status of the test in the Pass or Fail column, unless the test is specified as *data only*. Any marks in greyed-out fields indicate a test failure. Report any information listed in the Measured Data column. The Test Operator may record any additional observations.

Step	Procedure	Pass	Fail	Measured data
1	<u>3.5.1. KDM NonCriticalExtensions Element</u>			
2	<u>3.5.2. ETM IssueDate Field Check</u>			

4	<u>3.5.5. Certificate Thumbprint Check</u>			
5	<u>3.5.7. KeyInfo Field Check</u>			
6	<u>3.5.8. KDM Malformations</u>			
7	<u>3.5.9. KDM Signature</u>			
8	<u>5.1.1. SPB Digital Certificate</u>			
9	<u>5.3.2.1. Log Structure</u>			
10	<u>5.3.2.3. Log Sequence Numbers</u>			
11	<u>5.3.2.6. Log Report Signature Validity</u>			
12	<u>5.4.1.1. FrameSequencePlayed Event</u>			
13	<u>5.4.1.2. CPLStart Event</u>			
14	<u>5.4.1.3. CPLEnd Event</u>			
15	<u>5.4.1.4. PayoutComplete Event</u>			
16	<u>5.4.1.5. CPLCheck Event</u>			
17	<u>5.4.1.6. KDMKeysReceived Event</u>			
18	<u>5.4.1.7. KDMDeleted Event</u>			
19	<u>5.4.1.8. FrameSequencePlayed Event (OBAE)</u>			
20	<u>5.4.1.9. CPLStart Event (OBAE)</u>			
21	<u>5.4.1.10. CPLEnd Event (OBAE)</u>			
22	<u>5.4.1.11. PayoutComplete Event (OBAE)</u>			
23	<u>5.4.1.12. CPLCheck Event (OBAE)</u>			
24	<u>5.4.2.6. SPBStartup and SPBShutdown Events</u>			
25	<u>5.4.2.7. SPBOpen and SPBClose Events</u>			
26	<u>5.4.2.8. SPBClockAdjust Event</u>			
27	<u>5.4.2.9. SPBMarriage and SPBDivorce Events</u>			
28	<u>5.4.2.10. SPBSoftware Event</u>			
29	<u>5.4.2.11. SPBSecurityAlert Event</u>		(data only)	
30	<u>6.1.1. Image Integrity Checking</u>			
31	<u>6.1.2. Sound Integrity Checking</u>			
32	<u>6.1.4. Restriction of Keying to MD Type</u>			
33	<u>6.1.5. Restriction of Keying to Valid CPLs</u>			
34	<u>6.1.8. Content Key Extension, End of Engagement</u>			
35	<u>6.1.9. ContentAuthenticator Element Check</u>			
36	<u>6.1.10. KDM Date Check</u>			
37	<u>6.1.11. KDM TDL Check</u>			
38	<u>6.1.12. Maximum Number of DCP Keys</u>			
39	<u>6.1.13. CPL Id Check</u>			
40	<u>6.1.14. CPL Id Check (OBAE)</u>			
41	<u>6.1.15. Restriction of Playback in Absence of Integrity Pack Metadata</u>			

42	<u>6.1.16. Restriction of Keying to MDEK Type (OBAE)</u>			
43	<u>6.1.17. OBAE Integrity Checking</u>			
44	<u>6.1.19. Plurality of Media Block Identity Certificates</u>			
45	<u>6.1.20. Validity of SPB Certificates</u>			
46	<u>6.1.21. Maximum Number of DCP Keys (OBAE)</u>			
47	<u>6.1.22. Restriction of Keying to Valid CPLs (OBAE)</u>			
48	<u>6.3.1. Clock Adjustment</u>			
49	<u>6.3.2. SPB Type 1 Clock Battery</u>			
50	<u>6.3.3. Clock Resolution</u>			
51	<u>6.4.1. FM Application Constraints</u>			
52	<u>6.4.2. Granularity of FM Control</u>			
53	<u>6.4.3. FM Payload</u>			
54	<u>6.4.4. FM Audio Bypass</u>			
55	<u>6.4.5. Selective Audio FM Control</u>			
56	<u>6.4.6. FM Application Constraints (OBAE)</u>			
57	<u>6.4.7. Granularity of FM Control (OBAE)</u>			
58	<u>6.4.8. FM Payload (OBAE)</u>			
59	<u>6.4.9. FM Audio Bypass (OBAE)</u>			
60	<u>6.5.1. Playback of Image Only Material</u>			
61	<u>6.5.2. Decoder Requirements</u>			
62	<u>6.6.1. Digital Audio Interfaces</u>			
63	<u>6.6.2. Audio Sample Rate Conversion</u>			
64	<u>6.6.3. Audio Delay Setup</u>			
65	<u>6.6.4. Click Free Splicing of Audio Track Files</u>			
66	<u>6.7.1. Media Block Overlay</u>			
67	<u>6.7.4. Default Timed Text Font</u>			
68	<u>6.7.6. Timed Text Decryption</u>			
69	<u>6.8.1. Click Free Splicing of OBAE Track Files</u>			
70	<u>6.8.2. OBAE Delay Setup</u>			
71	<u>6.8.3. Maximum Bitrate OBAE</u>			
72	<u>6.8.4. OBAE Rendering Expectations</u>			
73	<u>7.3.2. Companion SPBs with Electronic Marriage</u>			
74	<u>7.3.3. Companion SPB Marriage Break Key Retaining</u>			
75	<u>8.1.3. Storage System Redundancy</u>			
76	<u>8.1.4. Storage System Performance</u>			
77	<u>8.1.6. Storage System Performance (OBAE)</u>			
78	<u>8.2.2. Show Playlist Creation</u>		(data only)	
79	<u>8.2.3. Show Playlist Format</u>			
80	<u>8.2.5. Automation Control and Interfaces</u>			

81	<u>8.2.6. Interrupt Free Playback</u>			
82	<u>8.2.7. Artifact Free Transition of Image Format</u>			
83	<u>8.2.8. Restarting Playback</u>			
84	<u>8.2.9. SMS User Accounts</u>			
85	<u>8.2.10. SMS Operator Identification</u>			
86	<u>8.2.11. SMS Identity and Certificate</u>			
87	<u>8.2.12. Content Keys and TDL check</u>			
88	<u>8.2.13. Content Keys and TDL check (OBAE)</u>			
89	<u>8.2.14. KDM Content Keys Check</u>			
90	<u>8.2.15. Validity of SMS Certificates</u>			
91	<u>8.2.16. Interrupt Free Playback (OBAE)</u>			
92	<u>8.2.17. Restarting Playback (OBAE)</u>			
93	<u>8.2.18. Show Playlist Creation (OBAE)</u>		(data only)	

21.3. Integrated IMBO Design Review

For each requirement listed in the table below, prove that the system design meets the requirement by identifying the software or hardware mechanism that implements the requirement and analyzing the design to assure that the requirement has been met, subject to stipulated conditions. If a proof cannot be made, the design will be considered non-compliant with regard to the requirement. To perform this analysis the examiner will require access to exhibit documents (system design artifacts) such as schematic diagrams, implementation source code, unit test source code, state diagrams, design notes, etc. See [Chapter 9: FIPS Requirements for a Type 1 SPB](#) and [Chapter 10: DCI Requirements Review](#) for more information.

For each requirement, the examiner must record the identifiers of the exhibits consulted in proving the requirement, including applicable version identifiers, section or sheet numbers, grid identifiers, etc., and the examiner must record Pass or Fail to indicate whether or not the requirement has been met by the design. The examiner may also record any notes relevant to interpreting the exhibits and to the determination of the compliance status

Step	Procedure	Pass	Fail	Exhibit Identifiers
1	<u>9.5.1. SM Operating Environment</u>			
2	<u>9.5.3. SPB Type 1 Tamper Responsiveness</u>			
3	<u>9.5.6. SPB Type 1 FIPS Requirements</u>			
4	<u>9.5.8. Asymmetric Key Generation</u>			
5	<u>9.5.9. Critical Security Parameter Protection</u>			
6	<u>9.5.11. Degraded mode(s) of operation prohibited</u>			
7	<u>9.5.12. Control output inhibition</u>			
8	<u>9.5.13. Maintenance role/interface prohibited</u>			
9	<u>9.5.14. Self-initiated cryptographic output capability</u>			
10	<u>9.5.15. Self-initiated cryptographic output capability</u>			
11	<u>9.5.16. Periodic self-tests</u>			
12	<u>10.4.1. Theater System Reliability</u>			
13	<u>10.4.2. Theater System Storage Security</u>			
14	<u>10.4.4. Security Entity Physical Protection</u>			
15	<u>10.4.5. Secure SMS-SM Communication</u>			

16	<u>10.4.6. Location of Security Manager</u>			
17	<u>10.4.16. KDM Purge upon Expiry</u>			
18	<u>10.4.22. Clock Date-Time-Range</u>			
19	<u>10.4.23. Clock Setup</u>			
20	<u>10.4.24. Clock Stability</u>			
21	<u>10.4.25. Repair and Renewal of SPBs</u>			
22	<u>10.4.27. Clock Continuity</u>			
23	<u>10.4.42. FM Algorithm General Requirements</u>			
24	<u>10.4.43. FM Insertion Requirements</u>			
25	<u>10.4.44. IFM Visual Transparency</u>			
26	<u>10.4.45. IFM Robustness</u>			
27	<u>10.4.46. AFM Inaudibility</u>			
28	<u>10.4.47. AFM Robustness</u>			
29	<u>10.4.48. FM Control Instance</u>			
30	<u>10.4.51. SPB Log Storage Requirements</u>			
31	<u>10.4.53. MB Log Storage Capabilities</u>			
32	<u>10.4.56. SPB Log Failure</u>			
33	<u>10.4.57. Log Purging in Failed SPBs</u>			
34	<u>10.4.58. MB Tasks</u>			
35	<u>10.4.59. Type 1 SPB RSA Private Keys</u>			
36	<u>10.4.60. Content Keys Outside Secure Silicon</u>			
37	<u>10.4.61. Prohibition of SPB Type 1 Field Serviceability</u>			
38	<u>10.4.62. Use of Software Protection Methods</u>			
39	<u>10.4.63. TMS Role</u>			
40	<u>10.4.64. D-Cinema Security Parameter Protection</u>			
41	<u>10.4.65. RSA Key Entropy</u>			
42	<u>10.4.66. Preloaded Symmetric Key Entropy</u>			
43	<u>10.4.67. Media Block Caching of Keys</u>			
44	<u>10.4.68. SPB Type 1 Firmware Modifications</u>			
45	<u>10.4.69. SPB Type 1 Log Retention</u>			
46	<u>10.4.72. SPB Secure Silicon Requirements</u>			
47	<u>10.4.73. SPB Type 1 Battery Life</u>			
48	<u>10.4.74. Companion SPB Retrieve Imaging Device Cert</u>			
49	<u>10.4.75. Log Collection for Married MB</u>			
50	<u>10.4.76. Companion SPB Single Purpose Requirement</u>			
51	<u>10.4.80. TLS Authentication of Dual Certificate SM</u>			
52	<u>10.4.82. Export of KDM-Borne Keys</u>			
53	<u>10.4.85. OBAE FM Robustness</u>			
54	<u>10.4.86. OBAE FM Inaudibility</u>			

21.4. Integrated IMBO Confidence Sequence

For each row of the table below, perform the procedure specified in the Procedure column, subject to all conditions specified in the Condition column. Indicate the status of the test in the Pass or Fail column, unless the test is specified as *data only*. Any marks in greyed-out fields indicate a test failure. Report any information listed in the Measured Data column. The Test Operator may record any additional observations.

Step	Procedure	Pass	Fail	Measured data
1	5.1.1. SPB Digital Certificate			
2	5.4.1.6. KDMKeysReceived Event			
3	5.4.2.10. SPBSoftware Event			
4	6.1.5. Restriction of Keying to Valid CPLs			
5	6.1.8. Content Key Extension, End of Engagement			
6	6.1.9. ContentAuthenticator Element Check			
7	6.1.11. KDM TDL Check			
8	6.1.20. Validity of SPB Certificates			
9	6.1.22. Restriction of Keying to Valid CPLs (OBAE)			
10	6.3.1. Clock Adjustment			
11	6.4.3. FM Payload			
12	6.4.8. FM Payload (OBAE)			
13	7.3.2. Companion SPBs with Electronic Marriage			
14	8.2.7. Artifact Free Transition of Image Format			
15	8.2.11. SMS Identity and Certificate			
16	8.2.12. Content Keys and TDL check			
17	8.2.13. Content Keys and TDL check (OBAE)			
18	8.2.15. Validity of SMS Certificates			

Chapter 22. Deleted Chapter

The chapter "OMB Consolidated Confidence Sequence" was moved to [20.4. OMB Confidence Sequence](#). The chapter number is maintained here to preserve the numbering of subsequent sections.

Chapter 23. Deleted Chapter

The chapter "Integrated IMBO Consolidated Confidence Sequence" was moved to [21.4. Integrated IMBO Confidence Sequence](#). The chapter number is maintained here to preserve the numbering of subsequent sections.

Chapter 24. SDR Projector Consolidated Test Sequence

24.1. Overview

The Test Subject of the Test Sequence defined in this chapter is a Projector that supports SDR presentations. The configuration and architecture of the system may vary, but the test sequence requires that the system consists of at least a light processing system including electronic and optical components (Projector), an IMB or IMBO (containing a Security Manager, Media Decryptor, etc.), and an SMS. For the purpose of this test, the Test Operator may substitute a Theater

Management Server/System (TMS) for the SMS if it implements the required functionality. Wherever a test procedure refers to an SMS, the equivalent TMS may also be used.

For the purpose of compliance testing as defined in this Chapter, the spatial resolution of the projector shall be no less than that of the Media Block.

Before performing the test sequence provided below, the Test Operator should read and understand the documentation provided with the Test Subject. If adequate documentation is not available, a Test Subject Representative should be available to provide assistance during the test session.

24.2. SDR Projector Test Sequence

For each row of the table below, perform the procedure specified in the Procedure column, subject to all conditions specified in the Condition column. Indicate the status of the test in the Pass or Fail column, unless the test is specified as *data only*. Any marks in greyed-out fields indicate a test failure. Report any information listed in the Measured Data column. The Test Operator may record any additional observations.

Step	Procedure	Pass	Fail	Measured data
1	<u>5.1.1. SPB Digital Certificate</u>			
2	<u>6.1.20. Validity of SPB Certificates</u>			
3	<u>6.4.3. FM Payload</u>			
4	<u>6.7.4. Default Timed Text Font</u>			
5	<u>7.2.1. Projector and Direct View Display Physical Protection</u>			
6	<u>7.2.2. Projector and Direct View Display Security Servicing</u>			
7	<u>7.2.6. SPB2 Secure Silicon Field Replacement</u>			
8	<u>7.2.7. Systems without Electronic Marriage</u>			
9	<u>7.2.8. Electronic Marriage Break Key Retaining</u>			
10	<u>7.5.3. Imaging Device Pixel Count/Structure</u>			
11	<u>7.5.8. SDR Intra-frame Contrast</u>			
12	<u>7.5.9. Grayscale Tracking</u>	(data only)		
13	<u>7.5.10. SDR Contouring</u>			
14	<u>7.5.11. SDR Transfer Function</u>			
15	<u>7.5.12. SDR Color Accuracy</u>			
16	<u>7.5.13. Projector Test Environment</u>			
17	<u>7.5.15. SDR White Luminance and Chromaticity</u>			
18	<u>7.5.29. SDR Minimum Active Black Level</u>			
19	<u>7.5.33. Image Frame Rates</u>			

24.3. SDR Projector Design Review

For each requirement listed in the table below, prove that the system design meets the requirement by identifying the software or hardware mechanism that implements the requirement and analyzing the design to assure that the requirement has been met, subject to stipulated conditions. If a proof cannot be made, the design will be considered non-compliant with regard to the requirement. To perform this analysis the examiner will require access to exhibit documents (system design artifacts) such as

schematic diagrams, implementation source code, unit test source code, state diagrams, design notes, etc. See [Chapter 9: FIPS Requirements for a Type 1 SPB](#) and [Chapter 10: DCI Requirements Review](#) for more information.

For each requirement, the examiner must record the identifiers of the exhibits consulted in proving the requirement, including applicable version identifiers, section or sheet numbers, grid identifiers, etc., and the examiner must record Pass or Fail to indicate whether or not the requirement has been met by the design. The examiner may also record any notes relevant to interpreting the exhibits and to the determination of the compliance status

Step	Procedure	Pass	Fail	Exhibit Identifiers
1	10.4.1. Theater System Reliability			
2	10.4.18. Imaging Device Secure Silicon Device			
3	10.4.19. Access to Imaging Device Image Signals			
4	10.4.20. Systems with Electronic Marriage			
5	10.4.21. Systems Without Electronic Marriage			
6	10.4.25. Repair and Renewal of SPBs			
7	10.4.26. SPB2 Protected Devices			
8	10.4.78. Imaging Device SPB Log Reporting Requirements			

24.4. SDR Projector Confidence Sequence

For each row of the table below, perform the procedure specified in the Procedure column, subject to all conditions specified in the Condition column. Indicate the status of the test in the Pass or Fail column, unless the test is specified as *data only*. Any marks in greyed-out fields indicate a test failure. Report any information listed in the Measured Data column. The Test Operator may record any additional observations.

Step	Procedure	Pass	Fail	Measured data
1	5.1.1. SPB Digital Certificate			
2	6.1.20. Validity of SPB Certificates			
3	6.4.3. FM Payload			
4	7.2.2. Projector and Direct View Display Security Servicing			
5	7.5.3. Imaging Device Pixel Count/Structure			

Chapter 25. Deleted Chapter

The chapter "Projector Consolidated Confidence Sequence" was moved to [24.4. SDR Projector Confidence Sequence](#). The chapter number is maintained here to preserve the numbering of subsequent sections.

Chapter 26. HDR Direct View Display Consolidated Test Sequence

26.1. Overview

The Test Subject of the Test Sequence defined in this chapter is a Direct View Display that supports both SDR and HDR presentations. The configuration and architecture of the system may vary, but the test sequence requires that the system consists of at least a light processing system including electronic and optical components (Direct View Display), an IMB or IMBO (containing a Security Manager, Media Decryptor, etc.), and a Screen Management Server (SMS). For the purpose of this test, the Test Operator may substitute a Theater Management Server (TMS) for the SMS if it implements the required functionality. Wherever a test procedure refers to an SMS, the equivalent TMS may also be used.

For the purpose of compliance testing as defined in this Chapter, the spatial resolution of the direct view display shall be no less than that of the Media Block.

Before performing the test sequence provided below, the Test Operator should read and understand the documentation provided with the Test Subject. If adequate documentation is not available, a Test Subject Representative should be available to provide assistance during the test session.

26.2. HDR Direct View Display Test Sequence

For each row of the table below, perform the procedure specified in the Procedure column, subject to all conditions specified in the Condition column. Indicate the status of the test in the Pass or Fail column, unless the test is specified as *data only*. Any marks in greyed-out fields indicate a test failure. Report any information listed in the Measured Data column. The Test Operator may record any additional observations.

Step	Procedure	Pass	Fail	Measured data
1	<u>5.1.1. SPB Digital Certificate</u>			
2	<u>6.1.20. Validity of SPB Certificates</u>			
3	<u>6.4.3. FM Payload</u>			
4	<u>7.2.1. Projector and Direct View Display Physical Protection</u>			
5	<u>7.2.2. Projector and Direct View Display Security Servicing</u>			
6	<u>7.2.6. SPB2 Secure Silicon Field Replacement</u>			
7	<u>7.2.7. Systems without Electronic Marriage</u>			
8	<u>7.2.8. Electronic Marriage Break Key Retaining</u>			
9	<u>7.5.3. Imaging Device Pixel Count/Structure</u>			
10	<u>7.5.8. SDR Intra-frame Contrast</u>			
11	<u>7.5.9. Grayscale Tracking</u>	(data only)		
12	<u>7.5.10. SDR Contouring</u>			
13	<u>7.5.11. SDR Transfer Function</u>			
14	<u>7.5.12. SDR Color Accuracy</u>			
15	<u>7.5.14. HDR White Luminance and Chromaticity</u>			
16	<u>7.5.15. SDR White Luminance and Chromaticity</u>			
17	<u>7.5.16. HDR Color Luminance and Chromaticity</u>			
18	<u>7.5.17. HDR Minimum Active Black Level</u>			
19	<u>7.5.18. SDR Inactive Black Level (Direct View Display)</u>			
20	<u>7.5.19. Horizontal and Vertical Full Screen Off-Axis Uniformity (Direct View Display)</u>			
21	<u>7.5.20. Stereoscopic Extinction Ratio</u>			
22	<u>7.5.21. SDR Stereoscopic Peak White Luminance</u>			
23	<u>7.5.22. Surface Reflectivity (Direct View Display)</u>			
24	<u>7.5.23. Vignetting (Direct View Display)</u>			
25	<u>7.5.24. SDR Stereoscopic Minimum Active Black Level</u>			

26	7.5.25. Image Upscaling Artifacts			
27	7.5.26. SDR Stereoscopic Color Accuracy			
28	7.5.27. Sub-pixel Spatial Coincidence (Direct View Display)			
29	7.5.28. HDR Transfer Function			
30	7.5.29. SDR Minimum Active Black Level			
31	7.5.30. Direct View Display Test Environment			
32	7.5.31. Automatic SDR/HDR mode switching			
33	7.5.32. HDR Inactive Black Level (Direct View Display)			
34	7.5.33. Image Frame Rates			
35	7.5.34. Stereoscopic Image Frame Rates			
36	7.5.35. HDR Contouring			

26.3. HDR Direct View Display Design Review

For each requirement listed in the table below, prove that the system design meets the requirement by identifying the software or hardware mechanism that implements the requirement and analyzing the design to assure that the requirement has been met, subject to stipulated conditions. If a proof cannot be made, the design will be considered non-compliant with regard to the requirement. To perform this analysis the examiner will require access to exhibit documents (system design artifacts) such as schematic diagrams, implementation source code, unit test source code, state diagrams, design notes, etc. See [Chapter 9: FIPS Requirements for a Type 1 SPB](#) and [Chapter 10: DCI Requirements Review](#) for more information.

For each requirement, the examiner must record the identifiers of the exhibits consulted in proving the requirement, including applicable version identifiers, section or sheet numbers, grid identifiers, etc., and the examiner must record *Pass* or *Fail* to indicate whether or not the requirement has been met by the design. The examiner may also record any notes relevant to interpreting the exhibits and to the determination of the compliance status.

Step	Procedure	Pass	Fail	Exhibit Identifiers
1	10.4.1. Theater System Reliability			
2	10.4.18. Imaging Device Secure Silicon Device			
3	10.4.19. Access to Imaging Device Image Signals			
4	10.4.20. Systems with Electronic Marriage			
5	10.4.21. Systems Without Electronic Marriage			
6	10.4.25. Repair and Renewal of SPBs			
7	10.4.26. SPB2 Protected Devices			
8	10.4.78. Imaging Device SPB Log Reporting Requirements			
9	10.5.1. Pixel Visibility (Direct View Display)			

26.4. HDR Direct View Display Confidence Sequence

For each row of the table below, perform the procedure specified in the Procedure column, subject to all conditions specified in the Condition column. Indicate the status of the test in the Pass or Fail column, unless the test is specified as *data only*. Any marks in greyed-out fields indicate a test failure. Report any information listed in the Measured Data column. The Test Operator may record any additional observations.

Step	Procedure	Pass	Fail	Measured data
------	-----------	------	------	---------------

1	<u>5.1.1. SPB Digital Certificate</u>			
2	<u>6.1.20. Validity of SPB Certificates</u>			
3	<u>6.4.3. FM Payload</u>			
4	<u>7.2.2. Projector and Direct View Display Security Servicing</u>			
5	<u>7.5.3. Imaging Device Pixel Count/Structure</u>			

Chapter 27. SDR Direct View Display Consolidated Test Sequence

27.1. Overview

The Test Subject of the Test Sequence defined in this chapter is a Direct View Display that supports SDR presentations. The configuration and architecture of the system may vary, but the test sequence requires that the system consists of at least a light processing system including electronic and optical components (Direct View Display), an IMB or IMBO (containing a Security Manager, Media Decryptor, etc.), and a Screen Management Server (SMS). For the purpose of this test, the Test Operator may substitute a Theater Management Server (TMS) for the SMS if it implements the required functionality. Wherever a test procedure refers to an SMS, the equivalent TMS may also be used.

For the purpose of compliance testing as defined in this Chapter, the spatial resolution of the direct view display shall be no less than that of the Media Block.

Before performing the test sequence provided below, the Test Operator should read and understand the documentation provided with the Test Subject. If adequate documentation is not available, a Test Subject Representative should be available to provide assistance during the test session.

27.2. SDR Direct View Display Test Sequence

For each row of the table below, perform the procedure specified in the Procedure column, subject to all conditions specified in the Condition column. Indicate the status of the test in the Pass or Fail column, unless the test is specified as *data only*. Any marks in greyed-out fields indicate a test failure. Report any information listed in the Measured Data column. The Test Operator may record any additional observations.

Step	Procedure	Pass	Fail	Measured data
1	<u>5.1.1. SPB Digital Certificate</u>			
2	<u>6.1.20. Validity of SPB Certificates</u>			
3	<u>6.4.3. FM Payload</u>			
4	<u>7.2.1. Projector and Direct View Display Physical Protection</u>			
5	<u>7.2.2. Projector and Direct View Display Security Servicing</u>			
6	<u>7.2.6. SPB2 Secure Silicon Field Replacement</u>			
7	<u>7.2.7. Systems without Electronic Marriage</u>			
8	<u>7.2.8. Electronic Marriage Break Key Retaining</u>			
9	<u>7.5.3. Imaging Device Pixel Count/Structure</u>			
10	<u>7.5.8. SDR Intra-frame Contrast</u>			
11	<u>7.5.9. Grayscale Tracking</u>	(data only)		
12	<u>7.5.10. SDR Contouring</u>			

13	<u>7.5.11. SDR Transfer Function</u>			
14	<u>7.5.12. SDR Color Accuracy</u>			
15	<u>7.5.15. SDR White Luminance and Chromaticity</u>			
16	<u>7.5.18. SDR Inactive Black Level (Direct View Display)</u>			
17	<u>7.5.19. Horizontal and Vertical Full Screen Off-Axis Uniformity (Direct View Display)</u>			
18	<u>7.5.20. Stereoscopic Extinction Ratio</u>			
19	<u>7.5.21. SDR Stereoscopic Peak White Luminance</u>			
20	<u>7.5.22. Surface Reflectivity (Direct View Display)</u>			
21	<u>7.5.23. Vignetting (Direct View Display)</u>			
22	<u>7.5.24. SDR Stereoscopic Minimum Active Black Level</u>			
23	<u>7.5.25. Image Upscaling Artifacts</u>			
24	<u>7.5.26. SDR Stereoscopic Color Accuracy</u>			
25	<u>7.5.27. Sub-pixel Spatial Coincidence (Direct View Display)</u>			
26	<u>7.5.29. SDR Minimum Active Black Level</u>			
27	<u>7.5.30. Direct View Display Test Environment</u>			
28	<u>7.5.33. Image Frame Rates</u>			
29	<u>7.5.34. Stereoscopic Image Frame Rates</u>			

27.3. SDR Direct View Display Design Review

For each requirement listed in the table below, prove that the system design meets the requirement by identifying the software or hardware mechanism that implements the requirement and analyzing the design to assure that the requirement has been met, subject to stipulated conditions. If a proof cannot be made, the design will be considered non-compliant with regard to the requirement. To perform this analysis the examiner will require access to exhibit documents (system design artifacts) such as schematic diagrams, implementation source code, unit test source code, state diagrams, design notes, etc. See [Chapter 9: FIPS Requirements for a Type 1 SPB](#) and [Chapter 10: DCI Requirements Review](#) for more information.

For each requirement, the examiner must record the identifiers of the exhibits consulted in proving the requirement, including applicable version identifiers, section or sheet numbers, grid identifiers, etc., and the examiner must record *Pass* or *Fail* to indicate whether or not the requirement has been met by the design. The examiner may also record any notes relevant to interpreting the exhibits and to the determination of the compliance status.

Step	Procedure	Pass	Fail	Exhibit Identifiers
1	<u>10.4.1. Theater System Reliability</u>			
2	<u>10.4.18. Imaging Device Secure Silicon Device</u>			
3	<u>10.4.19. Access to Imaging Device Image Signals</u>			
4	<u>10.4.20. Systems with Electronic Marriage</u>			
5	<u>10.4.21. Systems Without Electronic Marriage</u>			
6	<u>10.4.25. Repair and Renewal of SPBs</u>			
7	<u>10.4.26. SPB2 Protected Devices</u>			
8	<u>10.4.78. Imaging Device SPB Log Reporting Requirements</u>			
9	<u>10.5.1. Pixel Visibility (Direct View Display)</u>			

27.4. SDR Direct View Display Confidence Sequence

For each row of the table below, perform the procedure specified in the Procedure column, subject to all conditions specified in the Condition column. Indicate the status of the test in the Pass or Fail column, unless the test is specified as *data only*. Any marks in greyed-out fields indicate a test failure. Report any information listed in the Measured Data column. The Test Operator may record any additional observations.

Step	Procedure	Pass	Fail	Measured data
1	<u>5.1.1.1. SPB Digital Certificate</u>			
2	<u>6.1.20. Validity of SPB Certificates</u>			
3	<u>6.4.3. FM Payload</u>			
4	<u>7.2.2. Projector and Direct View Display Security Servicing</u>			
5	<u>7.5.3. Imaging Device Pixel Count/Structure</u>			

Chapter 28. HDR Projector Consolidated Test Sequence

28.1. Overview

The Test Subject of the Test Sequence defined in this chapter is a Projector that supports both SDR and HDR presentations. The configuration and architecture of the system may vary, but the test sequence requires that the system consists of at least a light processing system including electronic and optical components (Projector), an IMB or IMBO (containing a Security Manager, Media Decryptor, etc.), and an SMS. For the purpose of this test, the Test Operator may substitute a Theater Management Server/System (TMS) for the SMS if it implements the required functionality. Wherever a test procedure refers to an SMS, the equivalent TMS may also be used.

For the purpose of compliance testing as defined in this Chapter, the spatial resolution of the projector shall be no less than that of the Media Block.

Before performing the test sequence provided below, the Test Operator should read and understand the documentation provided with the Test Subject. If adequate documentation is not available, a Test Subject Representative should be available to provide assistance during the test session.

28.2. HDR Projector Test Sequence

For each row of the table below, perform the procedure specified in the Procedure column, subject to all conditions specified in the Condition column. Indicate the status of the test in the Pass or Fail column, unless the test is specified as *data only*. Any marks in greyed-out fields indicate a test failure. Report any information listed in the Measured Data column. The Test Operator may record any additional observations.

Step	Procedure	Pass	Fail	Measured data
1	<u>5.1.1.1. SPB Digital Certificate</u>			
2	<u>6.1.20. Validity of SPB Certificates</u>			
3	<u>6.4.3. FM Payload</u>			
4	<u>7.2.1. Projector and Direct View Display Physical Protection</u>			
5	<u>7.2.2. Projector and Direct View Display Security Servicing</u>			
6	<u>7.2.6. SPB2 Secure Silicon Field Replacement</u>			

	<u>7.2.7. Systems without Electronic Marriage</u>			
8	<u>7.2.8. Electronic Marriage Break Key Retaining</u>			
9	<u>7.5.3. Imaging Device Pixel Count/Structure</u>			
10	<u>7.5.8. SDR Intra-frame Contrast</u>			
11	<u>7.5.9. Grayscale Tracking</u>		(data only)	
12	<u>7.5.10. SDR Contouring</u>			
13	<u>7.5.11. SDR Transfer Function</u>			
14	<u>7.5.12. SDR Color Accuracy</u>			
15	<u>7.5.13. Projector Test Environment</u>			
16	<u>7.5.14. HDR White Luminance and Chromaticity</u>			
17	<u>7.5.15. SDR White Luminance and Chromaticity</u>			
18	<u>7.5.16. HDR Color Luminance and Chromaticity</u>			
19	<u>7.5.17. HDR Minimum Active Black Level</u>			
20	<u>7.5.28. HDR Transfer Function</u>			
21	<u>7.5.29. SDR Minimum Active Black Level</u>			
22	<u>7.5.31. Automatic SDR/HDR mode switching</u>			
23	<u>7.5.33. Image Frame Rates</u>			
24	<u>7.5.35. HDR Contouring</u>			

28.3. HDR Projector Design Review

For each requirement listed in the table below, prove that the system design meets the requirement by identifying the software or hardware mechanism that implements the requirement and analyzing the design to assure that the requirement has been met, subject to stipulated conditions. If a proof cannot be made, the design will be considered non-compliant with regard to the requirement. To perform this analysis the examiner will require access to exhibit documents (system design artifacts) such as schematic diagrams, implementation source code, unit test source code, state diagrams, design notes, etc. See [Chapter 9: FIPS Requirements for a Type 1 SPB](#) and [Chapter 10: DCI Requirements Review](#) for more information.

For each requirement, the examiner must record the identifiers of the exhibits consulted in proving the requirement, including applicable version identifiers, section or sheet numbers, grid identifiers, etc., and the examiner must record Pass or Fail to indicate whether or not the requirement has been met by the design. The examiner may also record any notes relevant to interpreting the exhibits and to the determination of the compliance status

Step	Procedure	Pass	Fail	Exhibit Identifiers
1	<u>10.4.1. Theater System Reliability</u>			
2	<u>10.4.18. Imaging Device Secure Silicon Device</u>			
3	<u>10.4.19. Access to Imaging Device Image Signals</u>			
4	<u>10.4.20. Systems with Electronic Marriage</u>			
5	<u>10.4.21. Systems Without Electronic Marriage</u>			
6	<u>10.4.25. Repair and Renewal of SPBs</u>			
7	<u>10.4.26. SPB2 Protected Devices</u>			
8	<u>10.4.78. Imaging Device SPB Log Reporting Requirements</u>			

28.4. HDR Projector Confidence Sequence

For each row of the table below, perform the procedure specified in the Procedure column, subject to all conditions specified in the Condition column. Indicate the status of the test in the Pass or Fail column, unless the test is specified as *data only*. Any marks in greyed-out fields indicate a test failure. Report any information listed in the Measured Data column. The Test Operator may record any additional observations.

Step	Procedure	Pass	Fail	Measured data
1	<u>5.1.1. SPB Digital Certificate</u>			
2	<u>6.1.20. Validity of SPB Certificates</u>			
3	<u>6.4.3. FM Payload</u>			
4	<u>7.2.2. Projector and Direct View Display Security Servicing</u>			
5	<u>7.5.3. Imaging Device Pixel Count/Structure</u>			

APPENDIX A. TEST MATERIALS

A.1. Overview

To facilitate consistent testing of d-cinema equipment, a set of reference files has been produced to be used as directed in the respective test procedures. These materials are described in detail in this Appendix with the intention that the materials can be re-created from the descriptions and used to achieve testing results equivalent to those achieved with the original reference files.

The test material described below consists of digital certificates, Key Delivery Messages (KDM) and D-Cinema Packages (DCP). A DCP can be further deconstructed as a set of Track Files, Composition Playlists and related file descriptions. Some Track Files will be encrypted.

Because the identity of a Test Subject cannot be known until the device has been manufactured, it is not possible to create reference KDM files in advance. It is therefore necessary to divide the test material into two categories: common-use reference material and per-device reference material. Common-use reference material can be created once and used without limit on any compliant system. Per-device reference material must be created for each Test Subject, with foreknowledge of the date and time of the test session.

Two additional categories of reference material exist: compliant and intentionally non-compliant. Most of the material will be "golden" reference files, intended to be entirely compliant with the relevant specifications. Other files, however, will be intentionally broken to allow testing of error detection and recovery mechanisms.

A.2. Images

A.2.1. Introduction

This section defines a set of MXF picture track files. For each track file, a description is given which details the images encoded in the file. The image track files will be combined with sound files to make complete compositions (see [Section A.4](#)).

A.2.2. Sync Count

Type	MXF j2c	
Filename	sync_count_j2c_pt.mxf	
Description	MXF track file containing five seconds (120 frames) of plain frames followed by a ten second countdown and five seconds of plain frames. The countdown consists of ten identical one-second count segments, from 9-0. Each count segment consists of twenty- four frames of the respective digit for the count period. The first frame of each count segment will have a punch set to indicate sync. The example image below shows the first frame of the fourth count period, which contains the number 6 (six).	
Conforms to	SMPTE-377-1, SMPTE-422, SMPTE-429-3, SMPTE-429-4	
Meta	Duration	00:00:20:00
	PixelArraySize	2048x1080
	EditRate	24/1

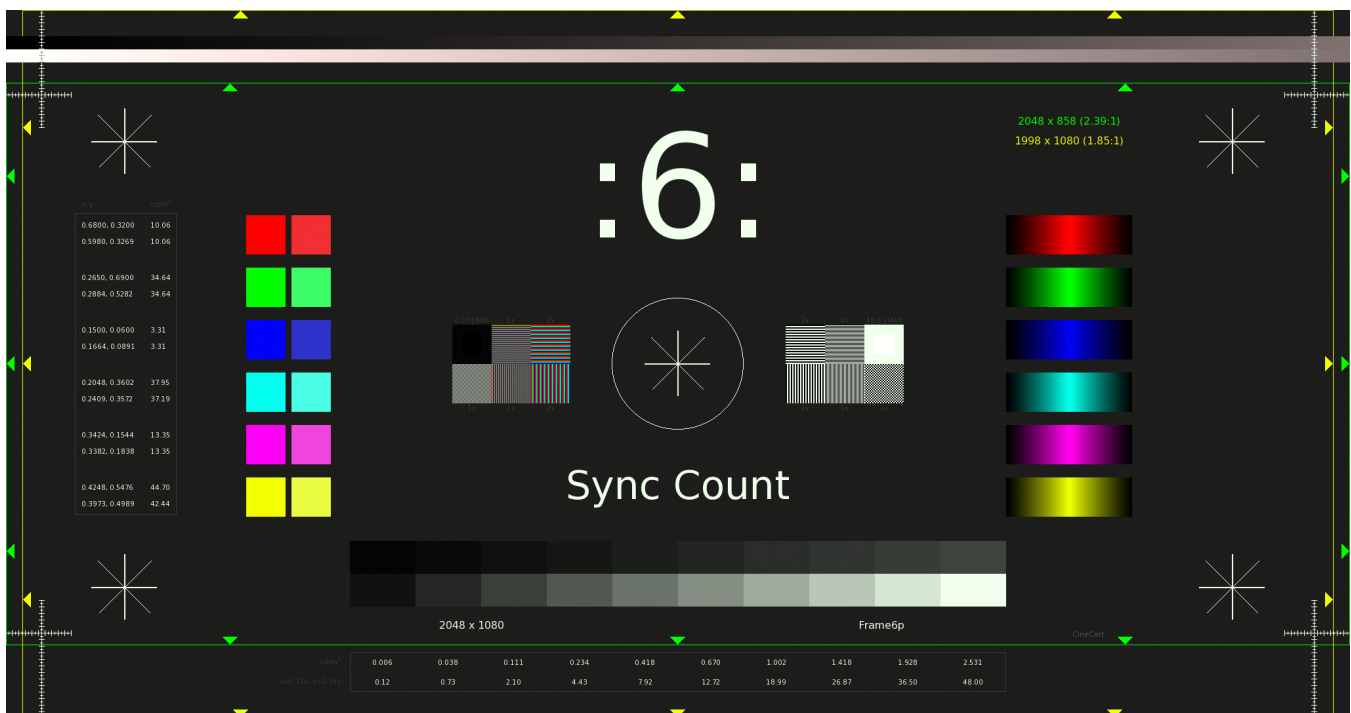

Figure A.2.2. Sync Count

A.2.3. Sync Count (Encrypted)

Type	MXF j2c	
Filename	sync_count_j2c_ct.mxf	
Description	Encrypted MXF track file, contents are identical to Section A.2.2: Sync Count .	
Conforms to	SMPTE-377-1, SMPTE-422, SMPTE-429-3, SMPTE-429-4, SMPTE-429-6	
Meta	Encryption	AES-128

Duration	00:00:20:00
PixelArraySize	2048x1080
EditRate	24/1

A.2.4. 4K Sync Count

Type	MXF j2c	
Filename	4K_sync_count_j2c_pt.mxf	
Description	4K Resolution MXF track file, contents are identical to Section A.2.2: Sync Count .	
Conforms to	SMPTE-377-1, SMPTE-422, SMPTE-429-3, SMPTE-429-4	
Meta	Duration	00:00:20:00
	PixelArraySize	4096x2160
	EditRate	24/1

A.2.5. Sync Count, 48fps

Type	MXF j2c	
Filename	sync_count_48fps_j2c_pt.mxf	
Description	48fps MXF track file containing five seconds (240 frames) of plain frames followed by a ten second countdown and five seconds of plain frames. The countdown consists of ten identical one- second count segments, from 9-0. Each count segment consists of forty- eight frames of the respective digit for the count period. The first two frames of each count segment will have a punch set to indicate sync.	
Conforms to	SMPTE-377-1, SMPTE-422, SMPTE-429-3, SMPTE-429-4	
Meta	Duration	00:20:00
	PixelArraySize	2048x1080
	EditRate	48/1

A.2.6. Channel I.D. 5.1

Type	MXF j2c	
Filename	channel_id_51_j2c_pt.mxf	
Description	MXF track file containing five seconds (120 frames) of plain frames followed by a thirty second audio channel identification set and five seconds of plain frames. The audio channel identification set consists of six identical five second identifier segments having the following consecutively displayed labels: Left, Center, Right, Left Surround, Right Surround, LFE. Each channel identifier segment consists of five seconds (120 frames) of the respective label.	

Conforms to	SMPTE-377-1, SMPTE-422, SMPTE-429-3, SMPTE-429-4	
Meta	Duration	00:00:40:00
	PixelArraySize	2048x1080
	EditRate	24/1

A.2.7. Channel I.D. 1-16

Type	MXF j2c	
Filename	channel_id_01-16_j2c_pt.mxf	
Description	MXF track file containing two seconds (48 frames) of plain frames followed by an eighty second audio channel identification set and two seconds of plain frames. The audio channel identification set consists of sixteen identical five-second identifier segments displaying consecutively numbered channel labels: 1, 2, 3, 4, etc. through 16. Each channel identifier segment consists of five seconds (120 frames) of the respective label.	
Conforms to	SMPTE-377-1, SMPTE-422, SMPTE-429-3, SMPTE-429-4	
Meta	Duration	00:01:24:00
	PixelArraySize	2048x1080
	EditRate	24/1

A.2.8. "NIST" 2K Test Pattern

Type	MXF j2c	
Filename	nist_2k_test_pattern_j2c_pt.mxf	
Description	MXF track file containing the "DCI NIST" pattern created during original DCI research project. The pattern (shown below) includes geometric dimensions, color chips, dimensional patterns, a grayscale gradient and full-color photographic images. The track file contains 30 seconds (720 frames) of this image. <i>Note: This image was obtained during the initial DCI study effort. It is used in the CTP because it is familiar to many in the d- cinema industry. The edge offset reticles are not accurate, however they are not used by any CTP procedure.</i>	
Conforms to	SMPTE-377-1, SMPTE-422, SMPTE-429-3, SMPTE-429-4	
Meta	Duration	00:00:30:00
	PixelArraySize	2048x1080
	EditRate	24/1

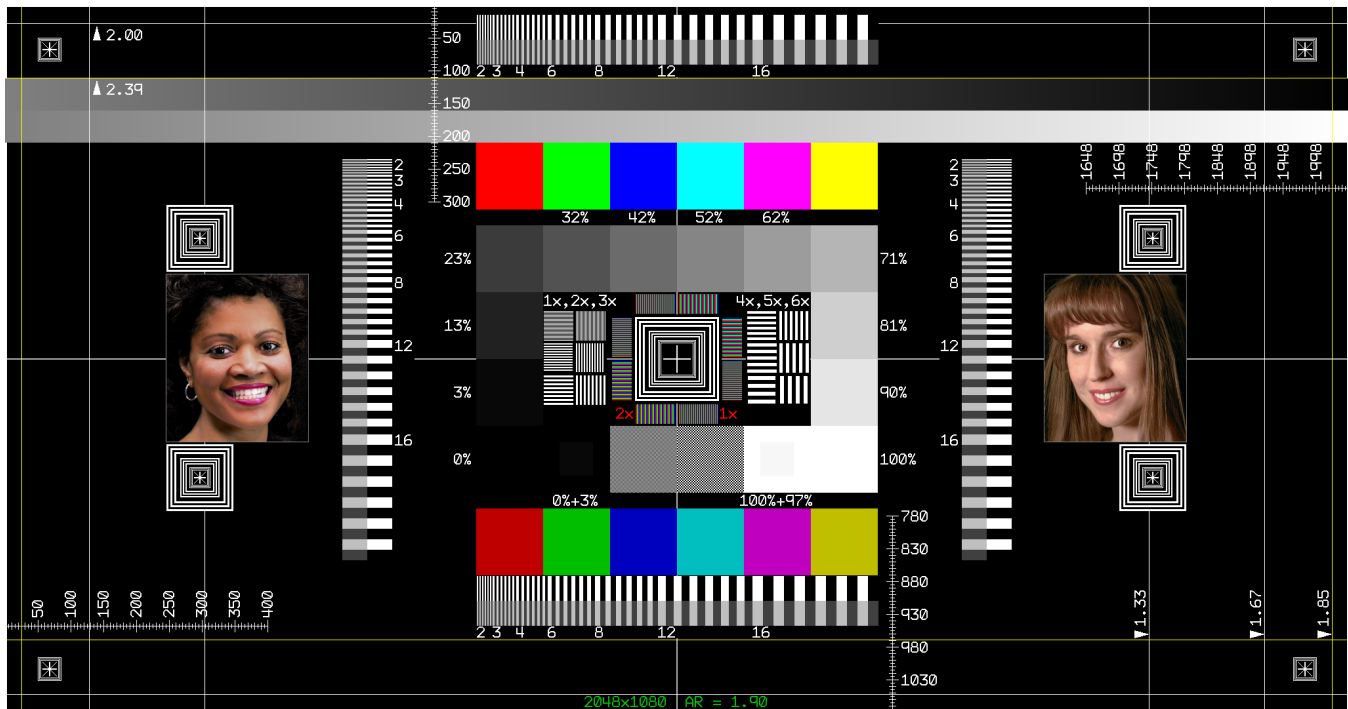

Figure A.2.8. "NIST" 2K Test Pattern

A.2.9. "NIST" 4K Test Pattern

Type	MXF j2c
Filename	4K_nist_test_pattern_j2c_pt.mxf
Description	4K Resolution MXF track file containing the "DCI NIST" pattern as shown in Section A.2.8: "NIST" 2K Test Pattern. The track file contains 30 seconds (720 frames) of this image. <i>Note: This image was obtained during the initial DCI study effort. It is used in the CTP because it is familiar to many in the d-cinema industry. The edge offset reticles are not accurate, however they are not used by any CTP procedure.</i>
Conforms to	SMPTE-377-1, SMPTE-422, SMPTE-429-3, SMPTE-429-4
Meta	<p>Duration 00:00:30:00</p> <p>PixelArraySize 4096x2160</p> <p>EditRate 24/1</p>

A.2.10. Black to Gray Step Series

Type	MXF j2c
Filename	gray_step_j2c_pt.mxf
Description	MXF track file containing five seconds (120 frames) of a chart showing all gray step values for the Black to Gray values in Section 7.5.9: Grayscale Tracking. This is followed by 1 minute of each of the 10 values as a full frame.

Conforms to	SMPTE-377-1, SMPTE-422, SMPTE-429-3, SMPTE-429-4, SMPTE-431-2	
Meta	Duration	00:11:05:00
	PixelArraySize	2048x1080
	EditRate	24/1



Figure A.2.10. Black to Gray Step Series

A.2.11. Black to White Step Series

Type	MXF j2c	
Filename	white_step_j2c_pt.mxf	
Description	MXF track file containing five seconds (120 frames) of a chart showing all gray step values for the Black to White values in Section 7.5.9: Grayscale Tracking . This is followed by 1 minute of each of the 10 values as a full frame.	
Conforms to	SMPTE-377-1, SMPTE-422, SMPTE-429-3, SMPTE-429-4, SMPTE-431-2	
Meta	Duration	00:11:05:00
	PixelArraySize	2048x1080
	EditRate	24/1



Figure A.2.11. Black to White Step Series

A.2.12. Color Accuracy Series

Type	MXF j2c	
Filename	color_accuracy_j2c_pt.mxf	
Description	MXF track file containing five seconds (120 frames) of a chart showing all color values for the test in Section 7.5.12: Color Accuracy. This is followed by 1 minute of each of the 12 color values as a full frame.	
Conforms to	SMPTE-377-1, SMPTE-422, SMPTE-429-3, SMPTE-429-4, SMPTE-431-2	
Meta	Duration	00:12:05:00
	PixelArraySize	2048x1080
	EditRate	24/1

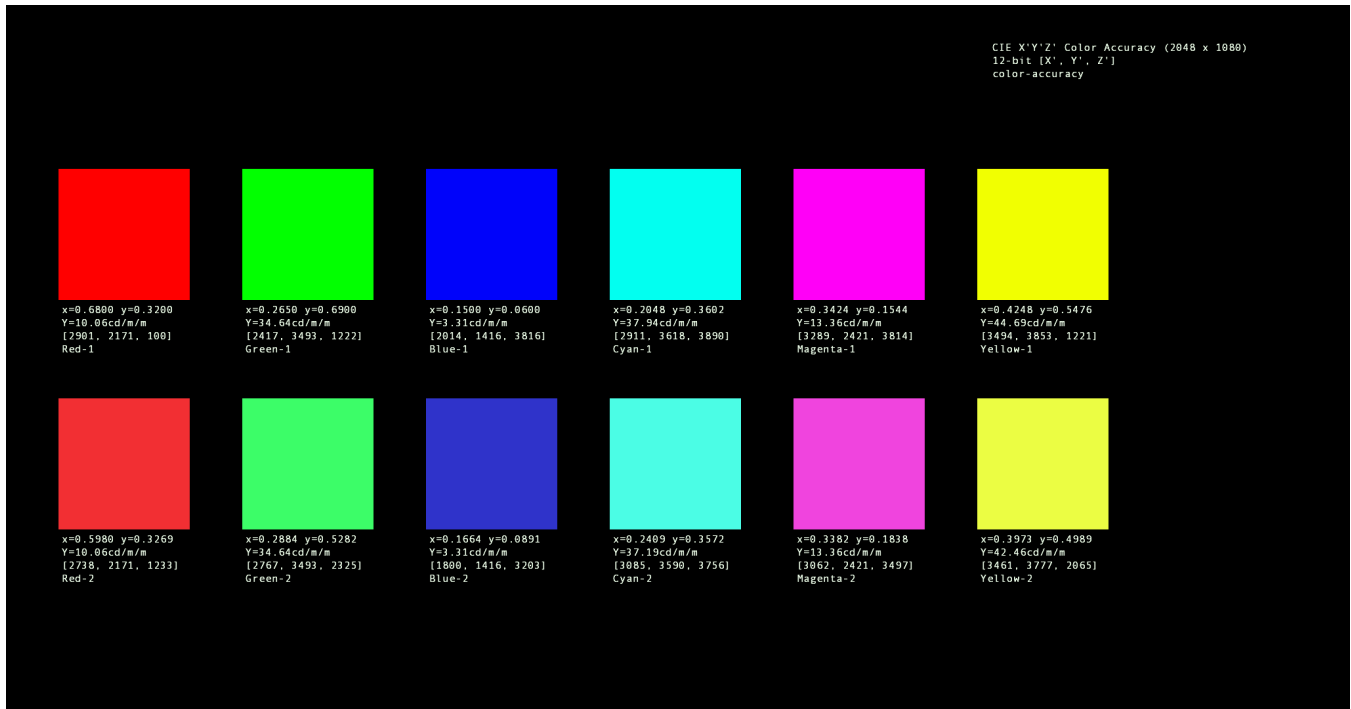

Figure A.2.12. Color Accuracy Series

A.2.13. 4K Color Accuracy Series

Type	MXF j2c	
Filename	4K_color_accuracy_j2c_pt.mxf	
Description	MXF track file containing the 4K version of the Color Accuracy Series shown in Section A.2.12: Color Accuracy Series .	
Conforms to	SMPTE-377-1, SMPTE-422, SMPTE-429-3, SMPTE-429-4, SMPTE-431-2	
Meta	Duration	12:05:00
	PixelArraySize	4096x2160
	EditRate	24/1

A.2.14. Black (Empty Frame)

Type	MXF j2c	
Filename	black_j2c_pt.mxf	
Description	MXF track file containing 30 seconds (720 frames) of black (all pixels zero).	
Conforms to	SMPTE-377-1, SMPTE-422, SMPTE-429-3, SMPTE-429-4	
Meta	Duration	00:00:30:00

PixelArraySize	2048x1080
EditRate	24/1

A.2.15. White (White Frame)

Type	MXF j2c						
Filename	white_j2c_pt.mxf						
Description	MXF track file containing 30 seconds (720 frames) of white.						
Conforms to	SMPTE-377-1, SMPTE-422, SMPTE-429-3, SMPTE-429-4						
Meta	<table border="0"> <tr> <td>Duration</td> <td>00:00:30:00</td> </tr> <tr> <td>PixelArraySize</td> <td>2048x1080</td> </tr> <tr> <td>EditRate</td> <td>24/1</td> </tr> </table>	Duration	00:00:30:00	PixelArraySize	2048x1080	EditRate	24/1
Duration	00:00:30:00						
PixelArraySize	2048x1080						
EditRate	24/1						

A.2.16. Intra-Frame Contrast Sequence

Type	MXF j2c						
Filename	2K_checkerboard_j2c_pt.mxf						
Description	MXF track file containing alternating checkerboard patterns and an aiming target.						
Conforms to	SMPTE-377-1, SMPTE-422, SMPTE-429-3, SMPTE-429-4, SMPTE-431-2						
Meta	<table border="0"> <tr> <td>Duration</td> <td>00:00:30:00</td> </tr> <tr> <td>PixelArraySize</td> <td>2048x1080</td> </tr> <tr> <td>EditRate</td> <td>24/1</td> </tr> </table>	Duration	00:00:30:00	PixelArraySize	2048x1080	EditRate	24/1
Duration	00:00:30:00						
PixelArraySize	2048x1080						
EditRate	24/1						

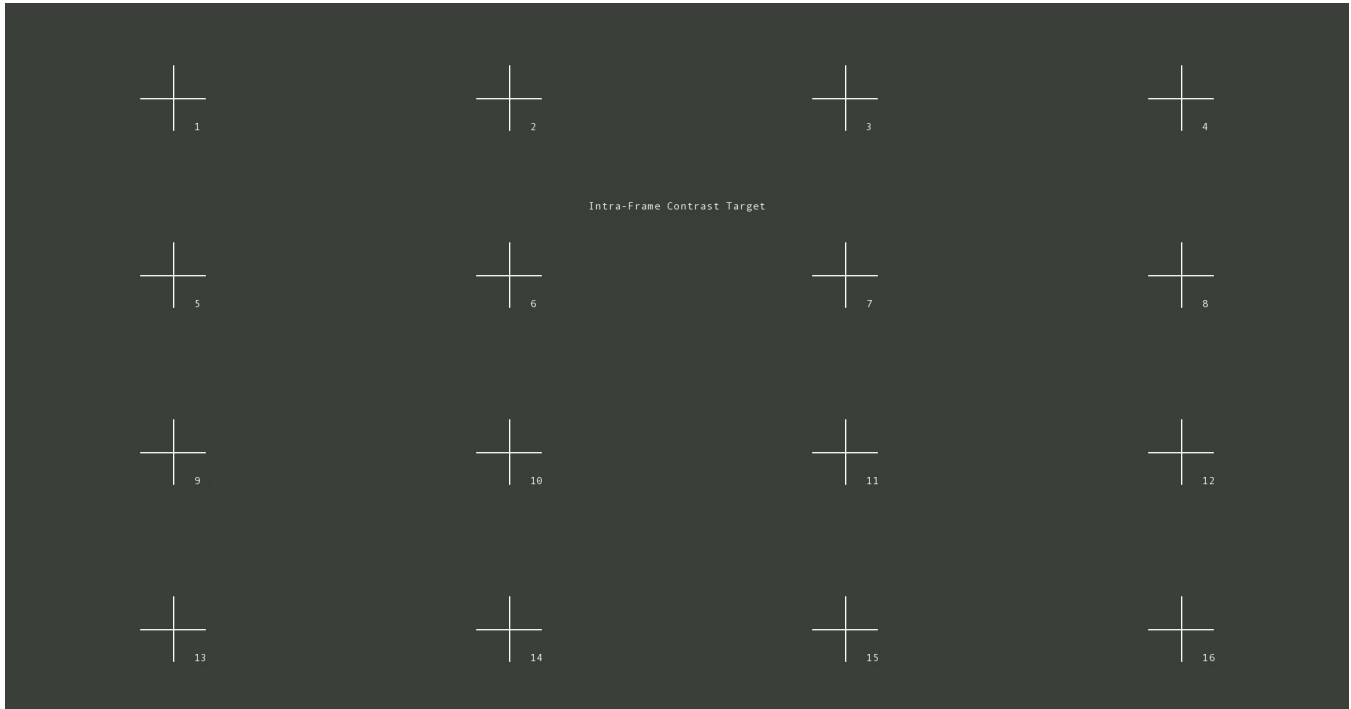

Figure A.2.16. Intra-Frame Contrast Sequence

A.2.17. Sequential Contrast Sequence

Type	MXF j2c	
Filename	2K_sequential_contrast_j2c_pt.mxf	
Description	MXF track file containing black, white and aiming target frames.	
Conforms to	SMPTE-377-1, SMPTE-422, SMPTE-429-3, SMPTE-429-4, SMPTE-431-2	
Meta	Duration	00:00:30:00
	PixelArraySize	2048x1080
	EditRate	24/1

A.2.18. 2K Picture Track File, Maximum Bitrate

Type	MXF j2c	
Filename	2K_max_bitrate_j2c_ct.mxf	
Description	Encrypted MXF track file containing a count to check synchronization between picture and sound, 10 minutes (14,400 frames) of a frame that has a large file size (1,281,818 bytes) and a second sync count.	
Conforms to	SMPTE-377-1, SMPTE-422, SMPTE-429-3, SMPTE-429-4	
Meta	Encryption	AES-128

Duration	00:10:40:00
PixelArraySize	2048x1080
EditRate	24/1

A.2.19. 4K Picture Track File, Maximum Bitrate

Type	MXF j2c								
Filename	4K_max_bitrate_j2c_ct.mxf								
Description	Encrypted MXF track file containing a count to check synchronization between picture and sound, 10 minutes (14,400 frames) of a frame that has a large file size (1,299,183 bytes) and a second sync count.								
Conforms to	SMPTE-377-1, SMPTE-422, SMPTE-429-3, SMPTE-429-4								
Meta	<table border="0"> <tr> <td>Encryption</td> <td>AES-128</td> </tr> <tr> <td>Duration</td> <td>00:10:40:00</td> </tr> <tr> <td>PixelArraySize</td> <td>4096x2160</td> </tr> <tr> <td>EditRate</td> <td>24/1</td> </tr> </table>	Encryption	AES-128	Duration	00:10:40:00	PixelArraySize	4096x2160	EditRate	24/1
Encryption	AES-128								
Duration	00:10:40:00								
PixelArraySize	4096x2160								
EditRate	24/1								

A.2.20. DCI Numbered Frame Sequence

Type	MXF j2c						
Filename	frame_num_burn_in_j2c_pt.mxf						
Description	MXF track file containing a sequence of the "DCI NIST" frame that has an overlay of two identical visible number fields. The five digit field contains 00000 in the first frame of the file, with each consecutive frame increasing the count by 1. The last frame will be numbered 07199.						
Conforms to	SMPTE-377-1, SMPTE-422, SMPTE-429-3, SMPTE-429-4						
Meta	<table border="0"> <tr> <td>Duration</td> <td>00:05:00:00</td> </tr> <tr> <td>PixelArraySize</td> <td>2048x1080</td> </tr> <tr> <td>EditRate</td> <td>24/1</td> </tr> </table>	Duration	00:05:00:00	PixelArraySize	2048x1080	EditRate	24/1
Duration	00:05:00:00						
PixelArraySize	2048x1080						
EditRate	24/1						

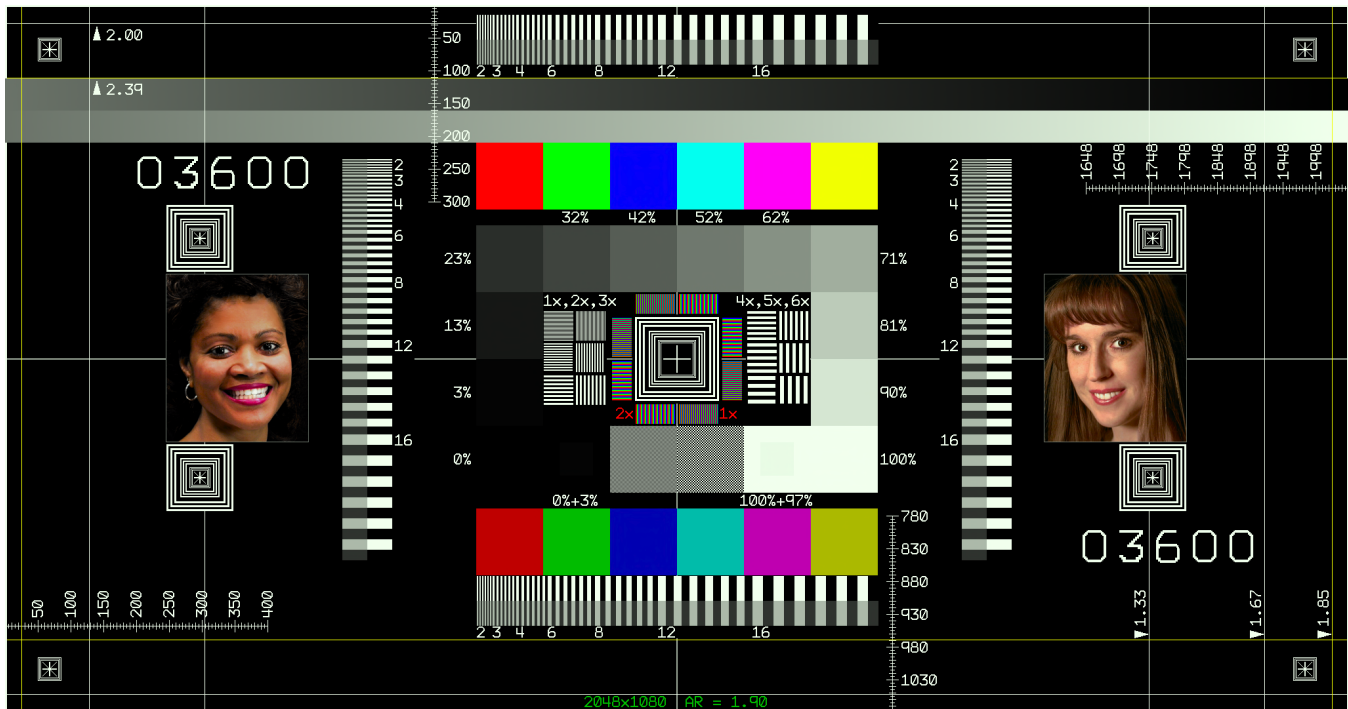

Figure A.2.20. DCI Numbered Frame Sequence

A.2.21. DCI Numbered Frame Sequence (Encrypted)

Type	MXF j2c	
Filename	frame_num_burn_in_j2c_ct.mxf	
Description	MXF track file containing a sequence of the "DCI NIST" frame that has an overlay of two identical visible number fields. The five digit field contains 00000 in the first frame of the file, with each consecutive frame increasing the count by 1. The last frame will be numbered 07199.	
Conforms to	SMPTE-377-1, SMPTE-422, SMPTE-429-3, SMPTE-429-4	
Meta	Encryption	AES-128
	Duration	00:05:00:00
	PixelArraySize	2048x1080
	EditRate	24/1

A.2.22. DCI Scope Transition Sequence

Type	MXF j2c	
Filename	transition-scope_j2c_pt.mxf	
Description	MXF track file containing a sequence of Scope format (A.R. 2.39:1) plain frames, and the label "Scope Transition Test Sequence (2048 x 858)". Each of the first 24 frames of the sequence have two identical	

	overlays displaying a number from 001 through 024. Each of the last 24 frames of the sequence have two identical overlays displaying a number from 024 through 001.	
Conforms to	SMPTE-377-1, SMPTE-422, SMPTE-429-3, SMPTE-429-4	
Meta	Duration	00:10:00
	PixelArraySize	2048x858
	EditRate	24/1

A.2.23. DCI Flat Transition Sequence

Type	MXF j2c	
Filename	transition-flat_j2c_pt.mxf	
Description	MXF track file containing a sequence of Flat format (A.R. 1.85:1) plain frames, and the label "Flat Transition Test Sequence (1998 x 1024)". Each of the first 24 frames of the sequence have two identical overlays displaying a number from 001 through 024. Each of the last 24 frames of the sequence have two identical overlays displaying a number from 024 through 001.	
Conforms to	SMPTE-377-1, SMPTE-422, SMPTE-429-3, SMPTE-429-4	
Meta	Duration	00:10:00
	PixelArraySize	1998x1080
	EditRate	24/1

A.2.24. StEM 2K

Type	MXF j2c	
Filename	StEM_2K_j2c_pt.mxf	
Description	MXF track file containing the complete DCI StEM Mini Movie.	
Conforms to	SMPTE-377-1, SMPTE-422, SMPTE-429-3, SMPTE-429-4	
Meta	Duration	11:31:21
	PixelArraySize	2048x858
	EditRate	24/1

A.2.25. StEM 2K (Encrypted)

Type	MXF j2c	
Filename	StEM_2K_j2c_ct.mxf	
Description	Encrypted MXF track file containing the complete DCI StEM Mini Movie.	

Conforms to	SMPTE-377-1, SMPTE-422, SMPTE-429-3, SMPTE-429-4, SMPTE-429-6	
Meta	Encryption	AES-128
	Duration	11:31:21
	PixelArraySize	2048x858
	EditRate	24/1

A.2.26. StEM 2K Multi-Reel A (Encrypted)

Type	MXF j2c multi	
Filename	StEM_2K_j2c_multi_A_ct_<segment>.mxf	
Description	A set of encrypted MXF track files containing 2k image essence for the DCI StEM Mini Movie. 128 files, each with a duration of 5 seconds.	
Conforms to	SMPTE-377-1, SMPTE-422, SMPTE-429-3, SMPTE-429-4, SMPTE-429-6	
Meta	SegmentCount	128
	Encryption	AES-128
	SegmentDuration	00:05:00
	Duration	00:10:40:00
	PixelArraySize	2048x858
	EditRate	24/1

A.2.27. StEM 2K Multi-Reel B (Encrypted)

Type	MXF j2c multi	
Filename	StEM_2K_j2c_multi_B_ct_<segment>.mxf	
Description	A set of encrypted MXF track files containing 2k image essence for the DCI StEM Mini Movie. Identical to StEM_2K_j2c_multi_A_ct	
Conforms to	SMPTE-377-1, SMPTE-422, SMPTE-429-3, SMPTE-429-4, SMPTE-429-6	
Meta	SegmentCount	128
	Encryption	AES-128
	SegmentDuration	00:05:00
	Duration	00:10:40:00
	PixelArraySize	2048x858

EditRate	24/1
-----------------	------

A.2.28. StEM 2K Multi-Reel A

Type	MXF j2c multi
Filename	StEM_2K_j2c_multi_A_pt_<segment>.mxf
Description	A set of plaintext MXF track files containing 2k image essence for the DCI StEM Mini Movie. 128 files, each with a duration of 5 seconds.
Conforms to	SMPTE-377-1, SMPTE-422, SMPTE-429-3, SMPTE-429-4, SMPTE-429-6
Meta	<p>SegmentCount 128</p> <p>SegmentDuration 00:05:00</p> <p>Duration 00:10:40:00</p> <p>PixelArraySize 2048x858</p> <p>EditRate 24/1</p>

A.2.29. StEM 2K Multi-Reel B

Type	MXF j2c multi
Filename	StEM_2K_j2c_multi_B_pt_<segment>.mxf
Description	A set of plaintext MXF track files containing 2k image essence for the DCI StEM Mini Movie. Identical to StEM_2K_j2c_multi_A_pt
Conforms to	SMPTE-377-1, SMPTE-422, SMPTE-429-3, SMPTE-429-4, SMPTE-429-6
Meta	<p>SegmentCount 128</p> <p>SegmentDuration 00:05:00</p> <p>Duration 00:10:40:00</p> <p>PixelArraySize 2048x858</p> <p>EditRate 24/1</p>

A.2.30. StEM 2K 48 fps

Type	MXF j2c
Filename	StEM_2K_48fps_j2c_pt.mxf
Description	MXF track file containing a 48 fps DCI StEM Mini Movie clip.
Conforms to	SMPTE-377-1, SMPTE-422, SMPTE-429-3, SMPTE-429-4

Meta	Duration	00:51:46
	PixelArraySize	2048x858
	EditRate	48/1

A.2.31. pixel_structure_N_2k_j2c_pt

Type	MXF j2c	
Filename	pixel_structure_N_2k_j2c_pt.mxf	
Description	See 7.5.3. Imaging Device Pixel Count/Structure for description.	
Conforms to	SMPTE-377-1, SMPTE-422, SMPTE-429-3, SMPTE-429-4, SMPTE-431-2	
Meta	Duration	00:00:10:00
	PixelArraySize	2048x1080
	EditRate	24/1

A.2.32. pixel_structure_S_2k_j2c_pt

Type	MXF j2c	
Filename	pixel_structure_S_2k_j2c_pt.mxf	
Description	See 7.5.3. Imaging Device Pixel Count/Structure for description.	
Conforms to	SMPTE-377-1, SMPTE-422, SMPTE-429-3, SMPTE-429-4, SMPTE-431-2	
Meta	Duration	00:00:10:00
	PixelArraySize	2048x1080
	EditRate	24/1

A.2.33. pixel_structure_E_2k_j2c_pt

Type	MXF j2c	
Filename	pixel_structure_E_2k_j2c_pt.mxf	
Description	See 7.5.3. Imaging Device Pixel Count/Structure for description.	
Conforms to	SMPTE-377-1, SMPTE-422, SMPTE-429-3, SMPTE-429-4, SMPTE-431-2	

Meta	Duration	00:00:10:00
	PixelArraySize	2048x1080
	EditRate	24/1

A.2.34. pixel_structure_W_2k_j2c_pt

Type	MXF j2c	
Filename	pixel_structure_W_2k_j2c_pt.mxf	
Description	See 7.5.3. Imaging Device Pixel Count/Structure for description.	
Conforms to	SMPTE-377-1, SMPTE-422, SMPTE-429-3, SMPTE-429-4, SMPTE-431-2	
Meta	Duration	00:00:10:00
	PixelArraySize	2048x1080
	EditRate	24/1

A.2.35. pixel_structure_N_4k_j2c_pt

Type	MXF j2c	
Filename	pixel_structure_N_4k_j2c_pt.mxf	
Description	See 7.5.3. Imaging Device Pixel Count/Structure for description.	
Conforms to	SMPTE-377-1, SMPTE-422, SMPTE-429-3, SMPTE-429-4, SMPTE-431-2	
Meta	Duration	00:00:10:00
	PixelArraySize	4096x2160
	EditRate	24/1

A.2.36. pixel_structure_S_4k_j2c_pt

Type	MXF j2c	
Filename	pixel_structure_S_4k_j2c_pt.mxf	
Description	See 7.5.3. Imaging Device Pixel Count/Structure for description.	
Conforms to	SMPTE-377-1, SMPTE-422, SMPTE-429-3, SMPTE-429-4, SMPTE-431-2	

Meta	Duration	00:00:10:00
	PixelArraySize	4096x2160
	EditRate	24/1

A.2.37. pixel_structure_E_4k_j2c_pt

Type	MXF j2c	
Filename	pixel_structure_E_4k_j2c_pt.mxf	
Description	See 7.5.3. Imaging Device Pixel Count/Structure for description.	
Conforms to	SMPTE-377-1, SMPTE-422, SMPTE-429-3, SMPTE-429-4, SMPTE-431-2	
Meta	Duration	00:00:10:00
	PixelArraySize	4096x2160
	EditRate	24/1

A.2.38. pixel_structure_W_4k_j2c_pt

Type	MXF j2c	
Filename	pixel_structure_W_4k_j2c_pt.mxf	
Description	See 7.5.3. Imaging Device Pixel Count/Structure for description.	
Conforms to	SMPTE-377-1, SMPTE-422, SMPTE-429-3, SMPTE-429-4, SMPTE-431-2	
Meta	Duration	00:00:10:00
	PixelArraySize	4096x2160
	EditRate	24/1

A.2.39. FM Constraints Begin (Encrypted)

Type	MXF j2c	
Filename	fm_constraints_begin_j2c_ct.mxf	
Description	Encrypted MXF track file with 10 seconds of slate reading "Begin Detection" and 5 seconds of black.	
Conforms to	SMPTE-377-1, SMPTE-422, SMPTE-429-3, SMPTE-429-4, SMPTE-429-6	
Meta	Encryption	AES-128
	Duration	00:00:15:00
	PixelArraySize	2048x858

EditRate	24/1
-----------------	------

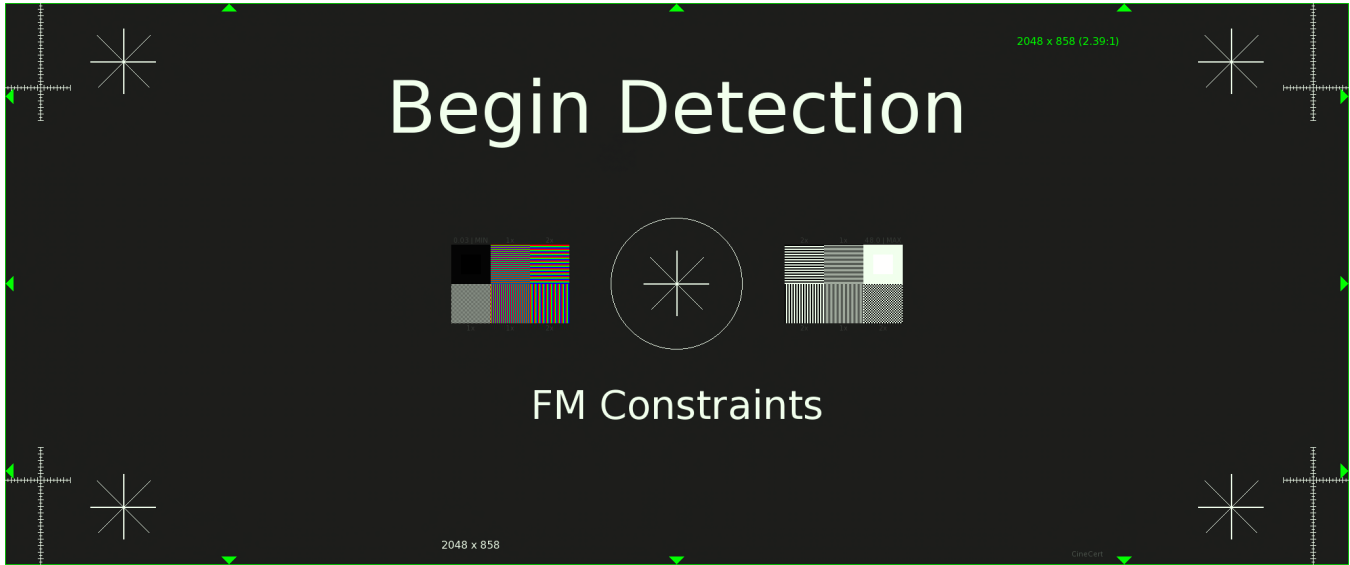

Figure A.2.39. FM Constraints Begin (Encrypted)

A.2.40. FM Constraints Begin (Plaintext)

Type	MXF j2c	
Filename	fm_constraints_begin_j2c_pt.mxf	
Description	Plaintext MXF track file with 10 seconds of slate reading "Begin Detection" and 5 seconds of black.	
Conforms to	SMPTE-377-1, SMPTE-422, SMPTE-429-3, SMPTE-429-4, SMPTE-429-6	
Meta	Duration	00:00:15:00
	PixelArraySize	2048x858
	EditRate	24/1

A.2.41. FM Constraints End (Encrypted)

Type	MXF j2c	
Filename	fm_constraints_end_j2c_ct.mxf	
Description	Encrypted MXF track file with 10 seconds of slate reading "End Detection" and 5 seconds of black.	
Conforms to	SMPTE-377-1, SMPTE-422, SMPTE-429-3, SMPTE-429-4, SMPTE-429-6	
Meta	Encryption	AES-128
	Duration	00:00:15:00
	PixelArraySize	2048x858

EditRate	24/1
-----------------	------

A.2.42. FM Constraints End (Plaintext)

Type	MXF j2c	
Filename	fm_constraints_end_j2c_pt.mxf	
Description	Plaintext MXF track file with 10 seconds of slate reading "End Detection" and 5 seconds of black.	
Conforms to	SMPTE-377-1, SMPTE-422, SMPTE-429-3, SMPTE-429-4, SMPTE-429-6	
Meta	Duration	00:00:15:00
	PixelArraySize	2048x858
	EditRate	24/1

A.2.43. 2K FM Control Granularity Begin (Encrypted)

Type	MXF j2c	
Filename	2K_fm_control_granularity_begin_j2c_ct.mxf	
Description	Encrypted MXF track file with 10 seconds of slate reading "Begin Detection" and 5 seconds of black.	
Conforms to	SMPTE-377-1, SMPTE-422, SMPTE-429-3, SMPTE-429-4, SMPTE-429-6	
Meta	Encryption	AES-128
	Duration	00:00:15:00
	PixelArraySize	2048x858
	EditRate	24/1

A.2.44. Deleted Section

The section "2K FM Control Granularity Begin" was deleted. The section number is maintained here to preserve the numbering of subsequent sections.

A.2.45. 2K FM Control Granularity End (Encrypted)

Type	MXF j2c	
Filename	2K_fm_control_granularity_end_j2c_ct.mxf	
Description	Encrypted MXF track file with 10 seconds of slate reading "End Detection" and 5 seconds of black.	
Conforms to	SMPTE-377-1, SMPTE-422, SMPTE-429-3, SMPTE-429-4, SMPTE-429-6	
Meta	Encryption	AES-128

Duration	00:00:15:00
PixelArraySize	2048x858
EditRate	24/1

A.2.46. Deleted Section

The section "2K FM Control Granularity End" was deleted. The section number is maintained here to preserve the numbering of subsequent sections.

A.2.47. 2K FM Payload Begin (Encrypted)

Type	MXF j2c	
Filename	2K_fm_payload_begin_j2c_ct.mxf	
Description	Encrypted MXF track file with 10 seconds of slate reading "Begin Detection" and 5 seconds of black.	
Conforms to	SMPTE-377-1, SMPTE-422, SMPTE-429-3, SMPTE-429-4, SMPTE-429-6	
Meta	Encryption	AES-128
	Duration	00:00:15:00
	PixelArraySize	2048x858
	EditRate	24/1

A.2.48. 2K FM Payload End (Encrypted)

Type	MXF j2c	
Filename	2K_fm_payload_end_j2c_ct.mxf	
Description	Encrypted MXF track file with 10 seconds of slate reading "End Detection" and 5 seconds of black.	
Conforms to	SMPTE-377-1, SMPTE-422, SMPTE-429-3, SMPTE-429-4, SMPTE-429-6	
Meta	Encryption	AES-128
	Duration	00:00:15:00
	PixelArraySize	2048x858
	EditRate	24/1

A.2.49. Binary Audio FM Bypass

Type	MXF j2c	
Filename	binary_audio_fm_bypass_j2c_pt.mxf	

Description	Plaintext MXF track file with 10 minutes of slate reading "Binary Audio FM Bypass".	
Conforms to	SMPTE-377-1, SMPTE-422, SMPTE-429-3, SMPTE-429-4, SMPTE-429-6	
Meta	Duration	00:10:00:00
	PixelArraySize	2048x858
	EditRate	24/1

A.2.50. Selective FM Begin

Type	MXF j2c	
Filename	selective_fm_begin_j2c_pt.mxf	
Description	Plaintext MXF track file with 10 seconds of slate reading "Begin Detection" and 5 seconds of black.	
Conforms to	SMPTE-377-1, SMPTE-422, SMPTE-429-3, SMPTE-429-4, SMPTE-429-6	
Meta	Duration	00:00:15:00
	PixelArraySize	2048x858
	EditRate	24/1

A.2.51. Selective FM End

Type	MXF j2c	
Filename	selective_fm_end_j2c_pt.mxf	
Description	Plaintext MXF track file with 10 seconds of slate reading "End Detection" and 5 seconds of black.	
Conforms to	SMPTE-377-1, SMPTE-422, SMPTE-429-3, SMPTE-429-4, SMPTE-429-6	
Meta	Duration	00:00:15:00
	PixelArraySize	2048x858
	EditRate	24/1

A.2.52. Timed Text Example with Missing Font

Type	MXF text	
Filename	std_ctp_text_no_font_pt.mxf	
Description	MXF track file containing timed text using an OpenType font.	
Conforms to	SMPTE-377-1, SMPTE-429-3, SMPTE-429-5	
Malformations	The font shall not be present in the track file.	

Meta	Duration	00:01:00:00
	EditRate	24/1

A.2.53. DCI_gradient_step_s_white_j2c_pt

Type	MXF j2c	
Filename	DCI_gradient_step_s_white_j2c_pt.mxf	
Description	See Section 6.5.2: Decoder Requirements for description.	
Conforms to	SMPTE-377-1, SMPTE-422, SMPTE-429-3, SMPTE-429-4, SMPTE-431-2	
Meta	Duration	00:00:16:16
	PixelArraySize	2048x1080
	EditRate	24/1



Figure A.2.53. DCI_gradient_step_s_white_j2c_pt

A.2.54. Deleted Section

The section "DCI_gradient_step_s_color_j2c_pt" was deleted. The section number is maintained here to preserve the numbering of subsequent sections.

A.2.55. Deleted Section

The section "Timed Text Example with Font" was deleted. The section number is maintained here to preserve the numbering of subsequent sections

A.2.56. Deleted Section

The section "Timed Text Example with PNG" was deleted. The section number is maintained here to preserve the numbering of subsequent sections.

A.2.57. Sync Count Text

Type	MXF text	
Filename	sync_count_tt_pt.mxf	
Description	MXF track file containing timed text using a font and images.	
Conforms to	SMPTE-377-1, SMPTE-429-3, SMPTE-429-5, SMPTE-428-7	
Meta	Duration	00:00:22:00
	EditRate	24/1

A.2.58. Sync Count Text (Encrypted)

Type	MXF text	
Filename	sync_count_tt_ct.mxf	
Description	Encrypted MXF track file containing timed text using a font and images.	
Conforms to	SMPTE-377-1, SMPTE-429-3, SMPTE-429-5	
Meta	Duration	00:00:22:00
	Encryption	AES-128
	EditRate	24/1

A.2.59. subtitle background

Type	MXF j2c	
Filename	subtitle_background_j2c_pt.mxf	
Conforms to	SMPTE-377-1, SMPTE-429-3, SMPTE-429-4, SMPTE-422	
Meta	Duration	00:01:00:00
	PixelArraySize	2048x858
	EditRate	24/1

A.2.60. Deleted Section

The section "Plain_Frame_nosub_j2c_ct" was deleted. The section number is maintained here to preserve the numbering of subsequent sections.

A.2.61. m01 Picture Frame Out Of Order (Encrypted)

Type	MXF j2c								
Filename	m01_pict_frame_oo_j2c_ct.mxf								
Description	Encrypted MXF track file containing the first 5 seconds (120 frames) of the NIST test pattern. The order of the first two frames has been deliberately swapped.								
Conforms to	SMPTE-377-1, SMPTE-422, SMPTE-429-3, SMPTE-429-4, SMPTE-429-6								
Malformations	The first two image frames of the track file have been swapped.								
Meta	<table><tr><td>Encryption</td><td>AES-128</td></tr><tr><td>Duration</td><td>00:00:05:00</td></tr><tr><td>PixelArraySize</td><td>2048x1080</td></tr><tr><td>EditRate</td><td>24/1</td></tr></table>	Encryption	AES-128	Duration	00:00:05:00	PixelArraySize	2048x1080	EditRate	24/1
Encryption	AES-128								
Duration	00:00:05:00								
PixelArraySize	2048x1080								
EditRate	24/1								

A.2.62. m03 Sound Splice

Type	MXF j2c						
Filename	m03_snd_splic_j2c_pt.mxf						
Description	MXF track file containing one minute (1440 frames) of plain frames with the label "m03 Sound Splice Test".						
Conforms to	SMPTE-377-1, SMPTE-422, SMPTE-429-3, SMPTE-429-4						
Meta	<table><tr><td>Duration</td><td>00:01:00:00</td></tr><tr><td>PixelArraySize</td><td>2048x1080</td></tr><tr><td>EditRate</td><td>24/1</td></tr></table>	Duration	00:01:00:00	PixelArraySize	2048x1080	EditRate	24/1
Duration	00:01:00:00						
PixelArraySize	2048x1080						
EditRate	24/1						

A.2.63. m05 Picture Track File With Wrong TrackFile ID (Encrypted)

Type	MXF j2c
Filename	m05_pict_wrong_file_j2c_ct.mxf
Description	MXF track file in which the integrity pack of the 7th frame has the TrackFile ID replaced with a different value.
Conforms to	SMPTE-377-1, SMPTE-422, SMPTE-429-3, SMPTE-429-4

Meta	Encryption	AES-128
	Duration	00:00:05:00
	PixelArraySize	2048x1080
	EditRate	24/1
	CiphertextHeader	yes

A.2.64. m09 Picture track file with bad HMAC (Encrypted)

Type	MXF j2c	
Filename	m09_pict_bad_hmac_j2c_ct.mxf	
Description	Picture track file in which one of the HMAC values for a single frame has been changed.	
Conforms to	SMPTE-377-1, SMPTE-422, SMPTE-429-3, SMPTE-429-4	
Malformations	The file contains a replacement EKL V packet for the seventh frame (index 6). The replacement packet is taken from another track file having a different PackageUID but encrypted with the same symmetric key.	
Meta	Encryption	AES-128
	Duration	00:00:05:00
	PixelArraySize	2048x1080
	EditRate	24/1
	CiphertextHeader	yes

A.2.65. m11 Picture With Bad Check Value (Encrypted)

Type	MXF j2c	
Filename	m11_pict_bad_chuk_j2c_ct.mxf	
Description	MXF track file containing one EKL V packet with an invalid Check Value.	
Conforms to	SMPTE-377-1, SMPTE-422, SMPTE-429-3, SMPTE-429-4	
Meta	Encryption	AES-128
	Duration	00:00:05:00
	PixelArraySize	2048x1080
	EditRate	24/1
	CiphertextHeader	yes

A.2.66. 2K Scope Subtitle Test Background - Reel 1

Type	MXF j2c
-------------	---------

Filename	sub_test_2K_scope_00_j2c_ct.mxf	
Conforms to	SMPTE-377-1, SMPTE-428-7, SMPTE-429-2, SMPTE-429-5, SMPTE-429-6	
Meta	Encryption	AES-128
	Duration	00:00:14:00
	PixelArraySize	2048x858
	EditRate	24/1

A.2.67. 2K Scope Subtitle Test Background - Reel 2

Type	MXF j2c	
Filename	sub_test_2K_scope_01_j2c_ct.mxf	
Conforms to	SMPTE-377-1, SMPTE-428-7, SMPTE-429-2, SMPTE-429-5, SMPTE-429-6	
Meta	Encryption	AES-128
	Duration	00:00:40:00
	PixelArraySize	2048x858
	EditRate	24/1

A.2.68. 2K Scope Subtitle Test Background - Reel 3

Type	MXF j2c	
Filename	sub_test_2K_scope_02_j2c_ct.mxf	
Conforms to	SMPTE-377-1, SMPTE-428-7, SMPTE-429-2, SMPTE-429-5, SMPTE-429-6	
Meta	Encryption	AES-128
	Duration	00:01:52:00
	PixelArraySize	2048x858
	EditRate	24/1

A.2.69. 2K Scope Subtitle Test Background - Reel 4

Type	MXF j2c	
Filename	sub_test_2K_scope_03_j2c_ct.mxf	
Conforms to	SMPTE-377-1, SMPTE-428-7, SMPTE-429-2, SMPTE-429-5, SMPTE-429-6	
Meta	Encryption	AES-128

Duration	00:00:20:00
PixelArraySize	2048x858
EditRate	24/1

A.2.70. 2K Scope Subtitle Test Background - Reel 5

Type	MXF j2c								
Filename	sub_test_2K_scope_04_j2c_ct.mxf								
Conforms to	SMPTE-377-1, SMPTE-428-7, SMPTE-429-2, SMPTE-429-5, SMPTE-429-6								
Meta	<table border="0"> <tr> <td>Encryption</td> <td>AES-128</td> </tr> <tr> <td>Duration</td> <td>00:00:10:00</td> </tr> <tr> <td>PixelArraySize</td> <td>2048x858</td> </tr> <tr> <td>EditRate</td> <td>24/1</td> </tr> </table>	Encryption	AES-128	Duration	00:00:10:00	PixelArraySize	2048x858	EditRate	24/1
Encryption	AES-128								
Duration	00:00:10:00								
PixelArraySize	2048x858								
EditRate	24/1								

A.2.71. 2K Scope Subtitle Test Background - Reel 6

Type	MXF j2c								
Filename	sub_test_2K_scope_05_j2c_ct.mxf								
Conforms to	SMPTE-377-1, SMPTE-428-7, SMPTE-429-2, SMPTE-429-5, SMPTE-429-6								
Meta	<table border="0"> <tr> <td>Encryption</td> <td>AES-128</td> </tr> <tr> <td>Duration</td> <td>00:00:15:00</td> </tr> <tr> <td>PixelArraySize</td> <td>2048x858</td> </tr> <tr> <td>EditRate</td> <td>24/1</td> </tr> </table>	Encryption	AES-128	Duration	00:00:15:00	PixelArraySize	2048x858	EditRate	24/1
Encryption	AES-128								
Duration	00:00:15:00								
PixelArraySize	2048x858								
EditRate	24/1								

A.2.72. 2K Scope Subtitle Test Background - Reel 7

Type	MXF j2c								
Filename	sub_test_2K_scope_06_j2c_ct.mxf								
Conforms to	SMPTE-377-1, SMPTE-428-7, SMPTE-429-2, SMPTE-429-5, SMPTE-429-6								
Meta	<table border="0"> <tr> <td>Encryption</td> <td>AES-128</td> </tr> <tr> <td>Duration</td> <td>00:01:31:00</td> </tr> <tr> <td>PixelArraySize</td> <td>2048x858</td> </tr> <tr> <td>EditRate</td> <td>24/1</td> </tr> </table>	Encryption	AES-128	Duration	00:01:31:00	PixelArraySize	2048x858	EditRate	24/1
Encryption	AES-128								
Duration	00:01:31:00								
PixelArraySize	2048x858								
EditRate	24/1								

A.2.73. 2K Scope Subtitle Test Background - Reel 8

Type	MXF j2c	
Filename	sub_test_2K_scope_07_j2c_ct.mxf	
Conforms to	SMPTE-377-1, SMPTE-428-7, SMPTE-429-2, SMPTE-429-5, SMPTE-429-6	
Meta	Encryption	AES-128
	Duration	00:00:10:00
	PixelArraySize	2048x858
	EditRate	24/1

A.2.74. 2K Scope Subtitle Test Background - Reel 9

Type	MXF j2c	
Filename	sub_test_2K_scope_08_j2c_ct.mxf	
Conforms to	SMPTE-377-1, SMPTE-428-7, SMPTE-429-2, SMPTE-429-5, SMPTE-429-6	
Meta	Encryption	AES-128
	Duration	00:01:45:00
	PixelArraySize	2048x858
	EditRate	24/1

A.2.75. 2K Scope Subtitle Test Background - Reel 10

Type	MXF j2c	
Filename	sub_test_2K_scope_09_j2c_ct.mxf	
Conforms to	SMPTE-377-1, SMPTE-428-7, SMPTE-429-2, SMPTE-429-5, SMPTE-429-6	
Meta	Encryption	AES-128
	Duration	00:00:30:00
	PixelArraySize	2048x858
	EditRate	24/1

A.2.76. 4K Scope Subtitle Test Background - Reel 1

Type	MXF j2c	
Filename	sub_test_4K_scope_00_j2c_ct.mxf	

Conforms to	SMPTE-377-1, SMPTE-428-7, SMPTE-429-2, SMPTE-429-5, SMPTE-429-6	
Meta	Encryption	AES-128
	Duration	00:00:14:00
	PixelArraySize	4096x1716
	EditRate	24/1

A.2.77. 4K Scope Subtitle Test Background - Reel 2

Type	MXF j2c	
Filename	sub_test_4K_scope_01_j2c_ct.mxf	
Conforms to	SMPTE-377-1, SMPTE-428-7, SMPTE-429-2, SMPTE-429-5, SMPTE-429-6	
Meta	Encryption	AES-128
	Duration	00:00:40:00
	PixelArraySize	4096x1716
	EditRate	24/1

A.2.78. 4K Scope Subtitle Test Background - Reel 3

Type	MXF j2c	
Filename	sub_test_4K_scope_02_j2c_ct.mxf	
Conforms to	SMPTE-377-1, SMPTE-428-7, SMPTE-429-2, SMPTE-429-5, SMPTE-429-6	
Meta	Encryption	AES-128
	Duration	00:01:52:00
	PixelArraySize	4096x1716
	EditRate	24/1

A.2.79. 4K Scope Subtitle Test Background - Reel 4

Type	MXF j2c	
Filename	sub_test_4K_scope_03_j2c_ct.mxf	
Conforms to	SMPTE-377-1, SMPTE-428-7, SMPTE-429-2, SMPTE-429-5, SMPTE-429-6	
Meta	Encryption	AES-128
	Duration	00:00:20:00

PixelArraySize	4096x1716
EditRate	24/1

A.2.80. 4K Scope Subtitle Test Background - Reel 5

Type	MXF j2c	
Filename	sub_test_4K_scope_04_j2c_ct.mxf	
Conforms to	SMPTE-377-1, SMPTE-428-7, SMPTE-429-2, SMPTE-429-5, SMPTE-429-6	
Meta	Encryption	AES-128
	Duration	00:00:10:00
	PixelArraySize	4096x1716
	EditRate	24/1

A.2.81. 4K Scope Subtitle Test Background - Reel 6

Type	MXF j2c	
Filename	sub_test_4K_scope_05_j2c_ct.mxf	
Conforms to	SMPTE-377-1, SMPTE-428-7, SMPTE-429-2, SMPTE-429-5, SMPTE-429-6	
Meta	Encryption	AES-128
	Duration	00:00:15:00
	PixelArraySize	4096x1716
	EditRate	24/1

A.2.82. 4K Scope Subtitle Test Background - Reel 7

Type	MXF j2c	
Filename	sub_test_4K_scope_06_j2c_ct.mxf	
Conforms to	SMPTE-377-1, SMPTE-428-7, SMPTE-429-2, SMPTE-429-5, SMPTE-429-6	
Meta	Encryption	AES-128
	Duration	00:01:31:00
	PixelArraySize	4096x1716
	EditRate	24/1

A.2.83. 4K Scope Subtitle Test Background - Reel 8

Type	MXF j2c	
Filename	sub_test_4K_scope_07_j2c_ct.mxf	
Conforms to	SMPTE-377-1, SMPTE-428-7, SMPTE-429-2, SMPTE-429-5, SMPTE-429-6	
Meta	Encryption	AES-128
	Duration	00:00:10:00
	PixelArraySize	4096x1716
	EditRate	24/1

A.2.84. 4K Scope Subtitle Test Background - Reel 9

Type	MXF j2c	
Filename	sub_test_4K_scope_08_j2c_ct.mxf	
Conforms to	SMPTE-377-1, SMPTE-428-7, SMPTE-429-2, SMPTE-429-5, SMPTE-429-6	
Meta	Encryption	AES-128
	Duration	00:01:45:00
	PixelArraySize	4096x1716
	EditRate	24/1

A.2.85. 4K Scope Subtitle Test Background - Reel 10

Type	MXF j2c	
Filename	sub_test_4K_scope_09_j2c_ct.mxf	
Conforms to	SMPTE-377-1, SMPTE-428-7, SMPTE-429-2, SMPTE-429-5, SMPTE-429-6	
Meta	Encryption	AES-128
	Duration	00:00:30:00
	PixelArraySize	4096x1716
	EditRate	24/1

A.2.86. 2K 48fps Scope Subtitle Test Background - Reel 1

Type	MXF j2c	
Filename	sub_test_48fps_scope_00_j2c_ct.mxf	

Conforms to	SMPTE-377-1, SMPTE-428-7, SMPTE-429-2, SMPTE-429-5, SMPTE-429-6	
Meta	Encryption	AES-128
	Duration	00:00:14:00
	PixelArraySize	2048x858
	EditRate	48/1

A.2.87. 2K 48fps Scope Subtitle Test Background - Reel 2

Type	MXF j2c	
Filename	sub_test_48fps_scope_01_j2c_ct.mxf	
Conforms to	SMPTE-377-1, SMPTE-428-7, SMPTE-429-2, SMPTE-429-5, SMPTE-429-6	
Meta	Encryption	AES-128
	Duration	00:00:40:00
	PixelArraySize	2048x858
	EditRate	48/1

A.2.88. 2K 48fps Scope Subtitle Test Background - Reel 3

Type	MXF j2c	
Filename	sub_test_48fps_scope_02_j2c_ct.mxf	
Conforms to	SMPTE-377-1, SMPTE-428-7, SMPTE-429-2, SMPTE-429-5, SMPTE-429-6	
Meta	Encryption	AES-128
	Duration	00:01:52:00
	PixelArraySize	2048x858
	EditRate	48/1

A.2.89. 2K 48fps Scope Subtitle Test Background - Reel 4

Type	MXF j2c	
Filename	sub_test_48fps_scope_03_j2c_ct.mxf	
Conforms to	SMPTE-377-1, SMPTE-428-7, SMPTE-429-2, SMPTE-429-5, SMPTE-429-6	
Meta	Encryption	AES-128
	Duration	00:00:20:00

PixelArraySize	2048x858
EditRate	48/1

A.2.90. 2K 48fps Scope Subtitle Test Background - Reel 5

Type	MXF j2c	
Filename	sub_test_48fps_scope_04_j2c_ct.mxf	
Conforms to	SMPTE-377-1, SMPTE-428-7, SMPTE-429-2, SMPTE-429-5, SMPTE-429-6	
Meta	Encryption	AES-128
	Duration	00:00:10:00
	PixelArraySize	2048x858
	EditRate	48/1

A.2.91. 2K 48fps Scope Subtitle Test Background - Reel 6

Type	MXF j2c	
Filename	sub_test_48fps_scope_05_j2c_ct.mxf	
Conforms to	SMPTE-377-1, SMPTE-428-7, SMPTE-429-2, SMPTE-429-5, SMPTE-429-6	
Meta	Encryption	AES-128
	Duration	00:00:15:00
	PixelArraySize	2048x858
	EditRate	48/1

A.2.92. 2K 48fps Scope Subtitle Test Background - Reel 7

Type	MXF j2c	
Filename	sub_test_48fps_scope_06_j2c_ct.mxf	
Conforms to	SMPTE-377-1, SMPTE-428-7, SMPTE-429-2, SMPTE-429-5, SMPTE-429-6	
Meta	Encryption	AES-128
	Duration	00:01:31:00
	PixelArraySize	2048x858
	EditRate	48/1

A.2.93. 2K 48fps Scope Subtitle Test Background - Reel 8

Type	MXF j2c	
Filename	sub_test_48fps_scope_07_j2c_ct.mxf	
Conforms to	SMPTE-377-1, SMPTE-428-7, SMPTE-429-2, SMPTE-429-5, SMPTE-429-6	
Meta	Encryption	AES-128
	Duration	00:00:10:00
	PixelArraySize	2048x858
	EditRate	48/1

A.2.94. 2K 48fps Scope Subtitle Test Background - Reel 9

Type	MXF j2c	
Filename	sub_test_48fps_scope_08_j2c_ct.mxf	
Conforms to	SMPTE-377-1, SMPTE-428-7, SMPTE-429-2, SMPTE-429-5, SMPTE-429-6	
Meta	Encryption	AES-128
	Duration	00:01:45:00
	PixelArraySize	2048x858
	EditRate	48/1

A.2.95. 2K 48fps Scope Subtitle Test Background - Reel 10

Type	MXF j2c	
Filename	sub_test_48fps_scope_09_j2c_ct.mxf	
Conforms to	SMPTE-377-1, SMPTE-428-7, SMPTE-429-2, SMPTE-429-5, SMPTE-429-6	
Meta	Encryption	AES-128
	Duration	00:00:30:00
	PixelArraySize	2048x858
	EditRate	48/1

A.2.96. 2K Flat Subtitle Test Background - Reel 1

Type	MXF j2c	
Filename	sub_test_2K_flat_00_j2c_ct.mxf	

Conforms to	SMPTE-377-1, SMPTE-428-7, SMPTE-429-2, SMPTE-429-5, SMPTE-429-6	
Meta	Encryption	AES-128
	Duration	00:00:14:00
	PixelArraySize	1998x1080
	EditRate	24/1

A.2.97. 2K Flat Subtitle Test Background - Reel 2

Type	MXF j2c	
Filename	sub_test_2K_flat_01_j2c_ct.mxf	
Conforms to	SMPTE-377-1, SMPTE-428-7, SMPTE-429-2, SMPTE-429-5, SMPTE-429-6	
Meta	Encryption	AES-128
	Duration	00:00:40:00
	PixelArraySize	1998x1080
	EditRate	24/1

A.2.98. 2K Flat Subtitle Test Background - Reel 3

Type	MXF j2c	
Filename	sub_test_2K_flat_02_j2c_ct.mxf	
Conforms to	SMPTE-377-1, SMPTE-428-7, SMPTE-429-2, SMPTE-429-5, SMPTE-429-6	
Meta	Encryption	AES-128
	Duration	00:01:52:00
	PixelArraySize	1998x1080
	EditRate	24/1

A.2.99. 2K Flat Subtitle Test Background - Reel 4

Type	MXF j2c	
Filename	sub_test_2K_flat_03_j2c_ct.mxf	
Conforms to	SMPTE-377-1, SMPTE-428-7, SMPTE-429-2, SMPTE-429-5, SMPTE-429-6	
Meta	Encryption	AES-128
	Duration	00:00:20:00

PixelArraySize	1998x1080
EditRate	24/1

A.2.100. 2K Flat Subtitle Test Background - Reel 5

Type	MXF j2c	
Filename	sub_test_2K_flat_04_j2c_ct.mxf	
Conforms to	SMPTE-377-1, SMPTE-428-7, SMPTE-429-2, SMPTE-429-5, SMPTE-429-6	
Meta	Encryption	AES-128
	Duration	00:00:10:00
	PixelArraySize	1998x1080
	EditRate	24/1

A.2.101. 2K Flat Subtitle Test Background - Reel 6

Type	MXF j2c	
Filename	sub_test_2K_flat_05_j2c_ct.mxf	
Conforms to	SMPTE-377-1, SMPTE-428-7, SMPTE-429-2, SMPTE-429-5, SMPTE-429-6	
Meta	Encryption	AES-128
	Duration	00:00:15:00
	PixelArraySize	1998x1080
	EditRate	24/1

A.2.102. 2K Flat Subtitle Test Background - Reel 7

Type	MXF j2c	
Filename	sub_test_2K_flat_06_j2c_ct.mxf	
Conforms to	SMPTE-377-1, SMPTE-428-7, SMPTE-429-2, SMPTE-429-5, SMPTE-429-6	
Meta	Encryption	AES-128
	Duration	00:01:31:00
	PixelArraySize	1998x1080
	EditRate	24/1

A.2.103. 2K Flat Subtitle Test Background - Reel 8

Type	MXF j2c	
Filename	sub_test_2K_flat_07_j2c_ct.mxf	
Conforms to	SMPTE-377-1, SMPTE-428-7, SMPTE-429-2, SMPTE-429-5, SMPTE-429-6	
Meta	Encryption	AES-128
	Duration	00:00:10:00
	PixelArraySize	1998x1080
	EditRate	24/1

A.2.104. 2K Flat Subtitle Test Background - Reel 9

Type	MXF j2c	
Filename	sub_test_2K_flat_08_j2c_ct.mxf	
Conforms to	SMPTE-377-1, SMPTE-428-7, SMPTE-429-2, SMPTE-429-5, SMPTE-429-6	
Meta	Encryption	AES-128
	Duration	00:01:45:00
	PixelArraySize	1998x1080
	EditRate	24/1

A.2.105. 2K Flat Subtitle Test Background - Reel 10

Type	MXF j2c	
Filename	sub_test_2K_flat_09_j2c_ct.mxf	
Conforms to	SMPTE-377-1, SMPTE-428-7, SMPTE-429-2, SMPTE-429-5, SMPTE-429-6	
Meta	Encryption	AES-128
	Duration	00:00:30:00
	PixelArraySize	1998x1080
	EditRate	24/1

A.2.106. 4K Flat Subtitle Test Background - Reel 1

Type	MXF j2c	
Filename	sub_test_4K_flat_00_j2c_ct.mxf	

Conforms to	SMPTE-377-1, SMPTE-428-7, SMPTE-429-2, SMPTE-429-5, SMPTE-429-6	
Meta	Encryption	AES-128
	Duration	00:00:14:00
	PixelArraySize	3996x2160
	EditRate	24/1

A.2.107. 4K Flat Subtitle Test Background - Reel 2

Type	MXF j2c	
Filename	sub_test_4K_flat_01_j2c_ct.mxf	
Conforms to	SMPTE-377-1, SMPTE-428-7, SMPTE-429-2, SMPTE-429-5, SMPTE-429-6	
Meta	Encryption	AES-128
	Duration	00:00:40:00
	PixelArraySize	3996x2160
	EditRate	24/1

A.2.108. 4K Flat Subtitle Test Background - Reel 3

Type	MXF j2c	
Filename	sub_test_4K_flat_02_j2c_ct.mxf	
Conforms to	SMPTE-377-1, SMPTE-428-7, SMPTE-429-2, SMPTE-429-5, SMPTE-429-6	
Meta	Encryption	AES-128
	Duration	00:01:52:00
	PixelArraySize	3996x2160
	EditRate	24/1

A.2.109. 4K Flat Subtitle Test Background - Reel 4

Type	MXF j2c	
Filename	sub_test_4K_flat_03_j2c_ct.mxf	
Conforms to	SMPTE-377-1, SMPTE-428-7, SMPTE-429-2, SMPTE-429-5, SMPTE-429-6	
Meta	Encryption	AES-128
	Duration	00:00:20:00

PixelArraySize	3996x2160
EditRate	24/1

A.2.110. 4K Flat Subtitle Test Background - Reel 5

Type	MXF j2c	
Filename	sub_test_4K_flat_04_j2c_ct.mxf	
Conforms to	SMPTE-377-1, SMPTE-428-7, SMPTE-429-2, SMPTE-429-5, SMPTE-429-6	
Meta	Encryption	AES-128
	Duration	00:00:10:00
	PixelArraySize	3996x2160
	EditRate	24/1

A.2.111. 4K Flat Subtitle Test Background - Reel 6

Type	MXF j2c	
Filename	sub_test_4K_flat_05_j2c_ct.mxf	
Conforms to	SMPTE-377-1, SMPTE-428-7, SMPTE-429-2, SMPTE-429-5, SMPTE-429-6	
Meta	Encryption	AES-128
	Duration	00:00:15:00
	PixelArraySize	3996x2160
	EditRate	24/1

A.2.112. 4K Flat Subtitle Test Background - Reel 7

Type	MXF j2c	
Filename	sub_test_4K_flat_06_j2c_ct.mxf	
Conforms to	SMPTE-377-1, SMPTE-428-7, SMPTE-429-2, SMPTE-429-5, SMPTE-429-6	
Meta	Encryption	AES-128
	Duration	00:01:31:00
	PixelArraySize	3996x2160
	EditRate	24/1

A.2.113. 4K Flat Subtitle Test Background - Reel 8

Type	MXF j2c	
Filename	sub_test_4K_flat_07_j2c_ct.mxf	
Conforms to	SMPTE-377-1, SMPTE-428-7, SMPTE-429-2, SMPTE-429-5, SMPTE-429-6	
Meta	Encryption	AES-128
	Duration	00:00:10:00
	PixelArraySize	3996x2160
	EditRate	24/1

A.2.114. 4K Flat Subtitle Test Background - Reel 9

Type	MXF j2c	
Filename	sub_test_4K_flat_08_j2c_ct.mxf	
Conforms to	SMPTE-377-1, SMPTE-428-7, SMPTE-429-2, SMPTE-429-5, SMPTE-429-6	
Meta	Encryption	AES-128
	Duration	00:01:45:00
	PixelArraySize	3996x2160
	EditRate	24/1

A.2.115. 4K Flat Subtitle Test Background - Reel 10

Type	MXF j2c	
Filename	sub_test_4K_flat_09_j2c_ct.mxf	
Conforms to	SMPTE-377-1, SMPTE-428-7, SMPTE-429-2, SMPTE-429-5, SMPTE-429-6	
Meta	Encryption	AES-128
	Duration	00:00:30:00
	PixelArraySize	3996x2160
	EditRate	24/1

A.2.116. 2K 48fps Flat Subtitle Test Background - Reel 1

Type	MXF j2c	
Filename	sub_test_48fps_flat_00_j2c_ct.mxf	

Conforms to	SMPTE-377-1, SMPTE-428-7, SMPTE-429-2, SMPTE-429-5, SMPTE-429-6	
Meta	Encryption	AES-128
	Duration	00:00:14:00
	PixelArraySize	1998x1080
	EditRate	48/1

A.2.117. 2K 48fps Flat Subtitle Test Background - Reel 2

Type	MXF j2c	
Filename	sub_test_48fps_flat_01_j2c_ct.mxf	
Conforms to	SMPTE-377-1, SMPTE-428-7, SMPTE-429-2, SMPTE-429-5, SMPTE-429-6	
Meta	Encryption	AES-128
	Duration	00:00:40:00
	PixelArraySize	1998x1080
	EditRate	48/1

A.2.118. 2K 48fps Flat Subtitle Test Background - Reel 3

Type	MXF j2c	
Filename	sub_test_48fps_flat_02_j2c_ct.mxf	
Conforms to	SMPTE-377-1, SMPTE-428-7, SMPTE-429-2, SMPTE-429-5, SMPTE-429-6	
Meta	Encryption	AES-128
	Duration	00:01:52:00
	PixelArraySize	1998x1080
	EditRate	48/1

A.2.119. 2K 48fps Flat Subtitle Test Background - Reel 4

Type	MXF j2c	
Filename	sub_test_48fps_flat_03_j2c_ct.mxf	
Conforms to	SMPTE-377-1, SMPTE-428-7, SMPTE-429-2, SMPTE-429-5, SMPTE-429-6	
Meta	Encryption	AES-128
	Duration	00:00:20:00

PixelArraySize	1998x1080
EditRate	48/1

A.2.120. 2K 48fps Flat Subtitle Test Background - Reel 5

Type	MXF j2c	
Filename	sub_test_48fps_flat_04_j2c_ct.mxf	
Conforms to	SMPTE-377-1, SMPTE-428-7, SMPTE-429-2, SMPTE-429-5, SMPTE-429-6	
Meta	Encryption	AES-128
	Duration	00:00:10:00
	PixelArraySize	1998x1080
	EditRate	48/1

A.2.121. 2K 48fps Flat Subtitle Test Background - Reel 6

Type	MXF j2c	
Filename	sub_test_48fps_flat_05_j2c_ct.mxf	
Conforms to	SMPTE-377-1, SMPTE-428-7, SMPTE-429-2, SMPTE-429-5, SMPTE-429-6	
Meta	Encryption	AES-128
	Duration	00:00:15:00
	PixelArraySize	1998x1080
	EditRate	48/1

A.2.122. 2K 48fps Flat Subtitle Test Background - Reel 7

Type	MXF j2c	
Filename	sub_test_48fps_flat_06_j2c_ct.mxf	
Conforms to	SMPTE-377-1, SMPTE-428-7, SMPTE-429-2, SMPTE-429-5, SMPTE-429-6	
Meta	Encryption	AES-128
	Duration	00:01:31:00
	PixelArraySize	1998x1080
	EditRate	48/1

A.2.123. 2K 48fps Flat Subtitle Test Background - Reel 8

Type	MXF j2c	
Filename	sub_test_48fps_flat_07_j2c_ct.mxf	
Conforms to	SMPTE-377-1, SMPTE-428-7, SMPTE-429-2, SMPTE-429-5, SMPTE-429-6	
Meta	Encryption	AES-128
	Duration	00:00:10:00
	PixelArraySize	1998x1080
	EditRate	48/1

A.2.124. 2K 48fps Flat Subtitle Test Background - Reel 9

Type	MXF j2c	
Filename	sub_test_48fps_flat_08_j2c_ct.mxf	
Conforms to	SMPTE-377-1, SMPTE-428-7, SMPTE-429-2, SMPTE-429-5, SMPTE-429-6	
Meta	Encryption	AES-128
	Duration	00:01:45:00
	PixelArraySize	2048x858
	EditRate	48/1

A.2.125. 2K 48fps Flat Subtitle Test Background - Reel 10

Type	MXF j2c	
Filename	sub_test_48fps_flat_09_j2c_ct.mxf	
Conforms to	SMPTE-377-1, SMPTE-428-7, SMPTE-429-2, SMPTE-429-5, SMPTE-429-6	
Meta	Encryption	AES-128
	Duration	00:00:30:00
	PixelArraySize	2048x858
	EditRate	48/1

A.2.126. 2K Full Subtitle Test Background - Reel 1

Type	MXF j2c	
Filename	sub_test_2K_full_00_j2c_ct.mxf	

Conforms to	SMPTE-377-1, SMPTE-428-7, SMPTE-429-2, SMPTE-429-5, SMPTE-429-6	
Meta	Encryption	AES-128
	Duration	00:00:14:00
	PixelArraySize	2048x1080
	EditRate	24/1

A.2.127. 2K Full Subtitle Test Background - Reel 2

Type	MXF j2c	
Filename	sub_test_2K_full_01_j2c_ct.mxf	
Conforms to	SMPTE-377-1, SMPTE-428-7, SMPTE-429-2, SMPTE-429-5, SMPTE-429-6	
Meta	Encryption	AES-128
	Duration	00:00:40:00
	PixelArraySize	2048x1080
	EditRate	24/1

A.2.128. 2K Full Subtitle Test Background - Reel 3

Type	MXF j2c	
Filename	sub_test_2K_full_02_j2c_ct.mxf	
Conforms to	SMPTE-377-1, SMPTE-428-7, SMPTE-429-2, SMPTE-429-5, SMPTE-429-6	
Meta	Encryption	AES-128
	Duration	00:01:52:00
	PixelArraySize	2048x1080
	EditRate	24/1

A.2.129. 2K Full Subtitle Test Background - Reel 4

Type	MXF j2c	
Filename	sub_test_2K_full_03_j2c_ct.mxf	
Conforms to	SMPTE-377-1, SMPTE-428-7, SMPTE-429-2, SMPTE-429-5, SMPTE-429-6	
Meta	Encryption	AES-128
	Duration	00:00:20:00

PixelArraySize	2048x1080
EditRate	24/1

A.2.130. 2K Full Subtitle Test Background - Reel 5

Type	MXF j2c	
Filename	sub_test_2K_full_04_j2c_ct.mxf	
Conforms to	SMPTE-377-1, SMPTE-428-7, SMPTE-429-2, SMPTE-429-5, SMPTE-429-6	
Meta	Encryption	AES-128
	Duration	00:00:10:00
	PixelArraySize	2048x1080
	EditRate	24/1

A.2.131. 2K Full Subtitle Test Background - Reel 6

Type	MXF j2c	
Filename	sub_test_2K_full_05_j2c_ct.mxf	
Conforms to	SMPTE-377-1, SMPTE-428-7, SMPTE-429-2, SMPTE-429-5, SMPTE-429-6	
Meta	Encryption	AES-128
	Duration	00:00:15:00
	PixelArraySize	2048x1080
	EditRate	24/1

A.2.132. 2K Full Subtitle Test Background - Reel 7

Type	MXF j2c	
Filename	sub_test_2K_full_06_j2c_ct.mxf	
Conforms to	SMPTE-377-1, SMPTE-428-7, SMPTE-429-2, SMPTE-429-5, SMPTE-429-6	
Meta	Encryption	AES-128
	Duration	00:01:31:00
	PixelArraySize	2048x1080
	EditRate	24/1

A.2.133. 2K Full Subtitle Test Background - Reel 8

Type	MXF j2c	
Filename	sub_test_2K_full_07_j2c_ct.mxf	
Conforms to	SMPTE-377-1, SMPTE-428-7, SMPTE-429-2, SMPTE-429-5, SMPTE-429-6	
Meta	Encryption	AES-128
	Duration	00:00:10:00
	PixelArraySize	2048x1080
	EditRate	24/1

A.2.134. 2K Full Subtitle Test Background - Reel 9

Type	MXF j2c	
Filename	sub_test_2K_full_08_j2c_ct.mxf	
Conforms to	SMPTE-377-1, SMPTE-428-7, SMPTE-429-2, SMPTE-429-5, SMPTE-429-6	
Meta	Encryption	AES-128
	Duration	00:01:45:00
	PixelArraySize	2048x1080
	EditRate	24/1

A.2.135. 2K Full Subtitle Test Background - Reel 10

Type	MXF j2c	
Filename	sub_test_2K_full_09_j2c_ct.mxf	
Conforms to	SMPTE-377-1, SMPTE-428-7, SMPTE-429-2, SMPTE-429-5, SMPTE-429-6	
Meta	Encryption	AES-128
	Duration	00:00:30:00
	PixelArraySize	2048x1080
	EditRate	24/1

A.2.136. 4K Full Subtitle Test Background - Reel 1

Type	MXF j2c	
Filename	sub_test_4K_full_00_j2c_ct.mxf	

Conforms to	SMPTE-377-1, SMPTE-428-7, SMPTE-429-2, SMPTE-429-5, SMPTE-429-6	
Meta	Encryption	AES-128
	Duration	00:00:14:00
	PixelArraySize	4096x2160
	EditRate	24/1

A.2.137. 4K Full Subtitle Test Background - Reel 2

Type	MXF j2c	
Filename	sub_test_4K_full_01_j2c_ct.mxf	
Conforms to	SMPTE-377-1, SMPTE-428-7, SMPTE-429-2, SMPTE-429-5, SMPTE-429-6	
Meta	Encryption	AES-128
	Duration	00:00:40:00
	PixelArraySize	4096x2160
	EditRate	24/1

A.2.138. 4K Full Subtitle Test Background - Reel 3

Type	MXF j2c	
Filename	sub_test_4K_full_02_j2c_ct.mxf	
Conforms to	SMPTE-377-1, SMPTE-428-7, SMPTE-429-2, SMPTE-429-5, SMPTE-429-6	
Meta	Encryption	AES-128
	Duration	00:01:52:00
	PixelArraySize	4096x2160
	EditRate	24/1

A.2.139. 4K Full Subtitle Test Background - Reel 4

Type	MXF j2c	
Filename	sub_test_4K_full_03_j2c_ct.mxf	
Conforms to	SMPTE-377-1, SMPTE-428-7, SMPTE-429-2, SMPTE-429-5, SMPTE-429-6	
Meta	Encryption	AES-128
	Duration	00:00:20:00

PixelArraySize	4096x2160
EditRate	24/1

A.2.140. 4K Full Subtitle Test Background - Reel 5

Type	MXF j2c	
Filename	sub_test_4K_full_04_j2c_ct.mxf	
Conforms to	SMPTE-377-1, SMPTE-428-7, SMPTE-429-2, SMPTE-429-5, SMPTE-429-6	
Meta	Encryption	AES-128
	Duration	00:00:10:00
	PixelArraySize	4096x2160
	EditRate	24/1

A.2.141. 4K Full Subtitle Test Background - Reel 6

Type	MXF j2c	
Filename	sub_test_4K_full_05_j2c_ct.mxf	
Conforms to	SMPTE-377-1, SMPTE-428-7, SMPTE-429-2, SMPTE-429-5, SMPTE-429-6	
Meta	Encryption	AES-128
	Duration	00:00:15:00
	PixelArraySize	4096x2160
	EditRate	24/1

A.2.142. 4K Full Subtitle Test Background - Reel 7

Type	MXF j2c	
Filename	sub_test_4K_full_06_j2c_ct.mxf	
Conforms to	SMPTE-377-1, SMPTE-428-7, SMPTE-429-2, SMPTE-429-5, SMPTE-429-6	
Meta	Encryption	AES-128
	Duration	00:01:31:00
	PixelArraySize	4096x2160
	EditRate	24/1

A.2.143. 4K Full Subtitle Test Background - Reel 8

Type	MXF j2c	
Filename	sub_test_4K_full_07_j2c_ct.mxf	
Conforms to	SMPTE-377-1, SMPTE-428-7, SMPTE-429-2, SMPTE-429-5, SMPTE-429-6	
Meta	Encryption	AES-128
	Duration	00:00:10:00
	PixelArraySize	4096x2160
	EditRate	24/1

A.2.144. 4K Full Subtitle Test Background - Reel 9

Type	MXF j2c	
Filename	sub_test_4K_full_08_j2c_ct.mxf	
Conforms to	SMPTE-377-1, SMPTE-428-7, SMPTE-429-2, SMPTE-429-5, SMPTE-429-6	
Meta	Encryption	AES-128
	Duration	00:01:45:00
	PixelArraySize	4096x2160
	EditRate	24/1

A.2.145. 4K Full Subtitle Test Background - Reel 10

Type	MXF j2c	
Filename	sub_test_4K_full_09_j2c_ct.mxf	
Conforms to	SMPTE-377-1, SMPTE-428-7, SMPTE-429-2, SMPTE-429-5, SMPTE-429-6	
Meta	Encryption	AES-128
	Duration	00:00:30:00
	PixelArraySize	4096x2160
	EditRate	24/1

A.2.146. 2K 48fps Full Subtitle Test Background - Reel 1

Type	MXF j2c	
Filename	sub_test_48fps_full_00_j2c_ct.mxf	

Conforms to	SMPTE-377-1, SMPTE-428-7, SMPTE-429-2, SMPTE-429-5, SMPTE-429-6	
Meta	Encryption	AES-128
	Duration	00:00:14:00
	PixelArraySize	2048x1080
	EditRate	48/1

A.2.147. 2K 48fps Full Subtitle Test Background - Reel 2

Type	MXF j2c	
Filename	sub_test_48fps_full_01_j2c_ct.mxf	
Conforms to	SMPTE-377-1, SMPTE-428-7, SMPTE-429-2, SMPTE-429-5, SMPTE-429-6	
Meta	Encryption	AES-128
	Duration	00:00:40:00
	PixelArraySize	2048x1080
	EditRate	48/1

A.2.148. 2K 48fps Full Subtitle Test Background - Reel 3

Type	MXF j2c	
Filename	sub_test_48fps_full_02_j2c_ct.mxf	
Conforms to	SMPTE-377-1, SMPTE-428-7, SMPTE-429-2, SMPTE-429-5, SMPTE-429-6	
Meta	Encryption	AES-128
	Duration	00:01:52:00
	PixelArraySize	2048x1080
	EditRate	48/1

A.2.149. 2K 48fps Full Subtitle Test Background - Reel 4

Type	MXF j2c	
Filename	sub_test_48fps_full_03_j2c_ct.mxf	
Conforms to	SMPTE-377-1, SMPTE-428-7, SMPTE-429-2, SMPTE-429-5, SMPTE-429-6	
Meta	Encryption	AES-128
	Duration	00:00:20:00

PixelArraySize	2048x1080
EditRate	48/1

A.2.150. 2K 48fps Full Subtitle Test Background - Reel 5

Type	MXF j2c	
Filename	sub_test_48fps_full_04_j2c_ct.mxf	
Conforms to	SMPTE-377-1, SMPTE-428-7, SMPTE-429-2, SMPTE-429-5, SMPTE-429-6	
Meta	Encryption	AES-128
	Duration	00:00:10:00
	PixelArraySize	2048x1080
	EditRate	48/1

A.2.151. 2K 48fps Full Subtitle Test Background - Reel 6

Type	MXF j2c	
Filename	sub_test_48fps_full_05_j2c_ct.mxf	
Conforms to	SMPTE-377-1, SMPTE-428-7, SMPTE-429-2, SMPTE-429-5, SMPTE-429-6	
Meta	Encryption	AES-128
	Duration	00:00:15:00
	PixelArraySize	2048x1080
	EditRate	48/1

A.2.152. 2K 48fps Full Subtitle Test Background - Reel 7

Type	MXF j2c	
Filename	sub_test_48fps_full_06_j2c_ct.mxf	
Conforms to	SMPTE-377-1, SMPTE-428-7, SMPTE-429-2, SMPTE-429-5, SMPTE-429-6	
Meta	Encryption	AES-128
	Duration	00:01:31:00
	PixelArraySize	2048x1080
	EditRate	48/1

A.2.153. 2K 48fps Full Subtitle Test Background - Reel 8

Type	MXF j2c	
Filename	sub_test_48fps_full_07_j2c_ct.mxf	
Conforms to	SMPTE-377-1, SMPTE-428-7, SMPTE-429-2, SMPTE-429-5, SMPTE-429-6	
Meta	Encryption	AES-128
	Duration	00:00:10:00
	PixelArraySize	2048x1080
	EditRate	48/1

A.2.154. 2K 48fps Full Subtitle Test Background - Reel 9

Type	MXF j2c	
Filename	sub_test_48fps_full_08_j2c_ct.mxf	
Conforms to	SMPTE-377-1, SMPTE-428-7, SMPTE-429-2, SMPTE-429-5, SMPTE-429-6	
Meta	Encryption	AES-128
	Duration	00:01:45:00
	PixelArraySize	2048x1080
	EditRate	48/1

A.2.155. 2K 48fps Full Subtitle Test Background - Reel 10

Type	MXF j2c	
Filename	sub_test_48fps_full_09_j2c_ct.mxf	
Conforms to	SMPTE-377-1, SMPTE-428-7, SMPTE-429-2, SMPTE-429-5, SMPTE-429-6	
Meta	Encryption	AES-128
	Duration	00:00:30:00
	PixelArraySize	2048x1080
	EditRate	48/1

A.2.156. 2K Scope Subtitle Test - Timed Text track file - Reel 1

Type	MXF text	
Filename	sub_test_2K_scope_00_tt_ct.mxf	

Description	Encrypted MXF track file containing timed text test content.	
Conforms to	SMPTE-377-1, SMPTE-428-7, SMPTE-429-5, SMPTE-429-6	
Meta	Duration	00:01:00:00
	Encryption	AES-128
	EditRate	24/1

A.2.157. 2K Scope Subtitle Test - Timed Text track file - Reel 2

Type	MXF text	
Filename	sub_test_2K_scope_01_tt_ct.mxf	
Description	Encrypted MXF track file containing timed text test content.	
Conforms to	SMPTE-377-1, SMPTE-428-7, SMPTE-429-5, SMPTE-429-6	
Meta	Duration	00:01:00:00
	Encryption	AES-128
	EditRate	24/1

A.2.158. 2K Scope Subtitle Test - Timed Text track file - Reel 3

Type	MXF text	
Filename	sub_test_2K_scope_02_tt_ct.mxf	
Description	Encrypted MXF track file containing timed text test content.	
Conforms to	SMPTE-377-1, SMPTE-428-7, SMPTE-429-5, SMPTE-429-6	
Meta	Duration	00:01:00:00
	Encryption	AES-128
	EditRate	24/1

A.2.159. 2K Scope Subtitle Test - Timed Text track file - Reel 4

Type	MXF text	
Filename	sub_test_2K_scope_03_tt_ct.mxf	
Description	Encrypted MXF track file containing timed text test content.	
Conforms to	SMPTE-377-1, SMPTE-428-7, SMPTE-429-5, SMPTE-429-6	
Meta	Duration	00:01:00:00

Encryption	AES-128
EditRate	24/1

A.2.160. 2K Scope Subtitle Test - Timed Text track file - Reel 5

Type	MXF text						
Filename	sub_test_2K_scope_04_tt_ct.mxf						
Description	Encrypted MXF track file containing timed text test content.						
Conforms to	SMPTE-377-1, SMPTE-428-7, SMPTE-429-5, SMPTE-429-6						
Meta	<table border="0"> <tr> <td>Duration</td> <td>00:01:00:00</td> </tr> <tr> <td>Encryption</td> <td>AES-128</td> </tr> <tr> <td>EditRate</td> <td>24/1</td> </tr> </table>	Duration	00:01:00:00	Encryption	AES-128	EditRate	24/1
Duration	00:01:00:00						
Encryption	AES-128						
EditRate	24/1						

A.2.161. 2K Scope Subtitle Test - Timed Text track file - Reel 6

Type	MXF text						
Filename	sub_test_2K_scope_05_tt_ct.mxf						
Description	Encrypted MXF track file containing timed text test content.						
Conforms to	SMPTE-377-1, SMPTE-428-7, SMPTE-429-5, SMPTE-429-6						
Meta	<table border="0"> <tr> <td>Duration</td> <td>00:01:00:00</td> </tr> <tr> <td>Encryption</td> <td>AES-128</td> </tr> <tr> <td>EditRate</td> <td>24/1</td> </tr> </table>	Duration	00:01:00:00	Encryption	AES-128	EditRate	24/1
Duration	00:01:00:00						
Encryption	AES-128						
EditRate	24/1						

A.2.162. 2K Scope Subtitle Test - Timed Text track file - Reel 7

Type	MXF text						
Filename	sub_test_2K_scope_06_tt_ct.mxf						
Description	Encrypted MXF track file containing timed text test content.						
Conforms to	SMPTE-377-1, SMPTE-428-7, SMPTE-429-5, SMPTE-429-6						
Meta	<table border="0"> <tr> <td>Duration</td> <td>00:01:00:00</td> </tr> <tr> <td>Encryption</td> <td>AES-128</td> </tr> <tr> <td>EditRate</td> <td>24/1</td> </tr> </table>	Duration	00:01:00:00	Encryption	AES-128	EditRate	24/1
Duration	00:01:00:00						
Encryption	AES-128						
EditRate	24/1						

A.2.163. 2K Scope Subtitle Test - Timed Text track file - Reel 8

Type	MXF text	
Filename	sub_test_2K_scope_07_tt_ct.mxf	
Description	Encrypted MXF track file containing timed text test content.	
Conforms to	SMPTE-377-1, SMPTE-428-7, SMPTE-429-5, SMPTE-429-6	
Meta	Duration	00:01:00:00
	Encryption	AES-128
	EditRate	24/1

A.2.164. 2K Scope Subtitle Test - Timed Text track file - Reel 9

Type	MXF text	
Filename	sub_test_2K_scope_08_tt_ct.mxf	
Description	Encrypted MXF track file containing timed text test content.	
Conforms to	SMPTE-377-1, SMPTE-428-7, SMPTE-429-5, SMPTE-429-6	
Meta	Duration	00:01:00:00
	Encryption	AES-128
	EditRate	24/1

A.2.165. 2K Scope Subtitle Test - Timed Text track file - Reel 10

Type	MXF text	
Filename	sub_test_2K_scope_09_tt_ct.mxf	
Description	Encrypted MXF track file containing timed text test content.	
Conforms to	SMPTE-377-1, SMPTE-428-7, SMPTE-429-5, SMPTE-429-6	
Meta	Duration	00:01:00:00
	Encryption	AES-128
	EditRate	24/1

A.2.166. 4K Scope Subtitle Test - Timed Text track file - Reel 8

Type	MXF text	
Filename	sub_test_4K_scope_07_tt_ct.mxf	

Description	Encrypted MXF track file containing timed text test content.	
Conforms to	SMPTE-377-1, SMPTE-428-7, SMPTE-429-5, SMPTE-429-6	
Meta	Duration	00:01:00:00
	Encryption	AES-128
	EditRate	24/1

A.2.167. 4K Scope Subtitle Test - Timed Text track file - Reel 9

Type	MXF text	
Filename	sub_test_4K_scope_08_tt_ct.mxf	
Description	Encrypted MXF track file containing timed text test content.	
Conforms to	SMPTE-377-1, SMPTE-428-7, SMPTE-429-5, SMPTE-429-6	
Meta	Duration	00:01:00:00
	Encryption	AES-128
	EditRate	24/1

A.2.168. 2K 48fps Scope Subtitle Test - Timed Text track file - Reel 1

Type	MXF text	
Filename	sub_test_48fps_scope_00_tt_ct.mxf	
Description	Encrypted MXF track file containing timed text test content.	
Conforms to	SMPTE-377-1, SMPTE-428-7, SMPTE-429-5, SMPTE-429-6	
Meta	Duration	00:01:00:00
	Encryption	AES-128
	EditRate	48/1

A.2.169. 2K 48fps Scope Subtitle Test - Timed Text track file - Reel 2

Type	MXF text	
Filename	sub_test_48fps_scope_01_tt_ct.mxf	
Description	Encrypted MXF track file containing timed text test content.	
Conforms to	SMPTE-377-1, SMPTE-428-7, SMPTE-429-5, SMPTE-429-6	
Meta	Duration	00:01:00:00

Encryption	AES-128
EditRate	48/1

A.2.170. 2K 48fps Scope Subtitle Test - Timed Text track file - Reel 3

Type	MXF text	
Filename	sub_test_48fps_scope_02_tt_ct.mxf	
Description	Encrypted MXF track file containing timed text test content.	
Conforms to	SMPTE-377-1, SMPTE-428-7, SMPTE-429-5, SMPTE-429-6	
Meta	Duration	00:01:00:00
	Encryption	AES-128
	EditRate	48/1

A.2.171. 2K 48fps Scope Subtitle Test - Timed Text track file - Reel 4

Type	MXF text	
Filename	sub_test_48fps_scope_03_tt_ct.mxf	
Description	Encrypted MXF track file containing timed text test content.	
Conforms to	SMPTE-377-1, SMPTE-428-7, SMPTE-429-5, SMPTE-429-6	
Meta	Duration	00:01:00:00
	Encryption	AES-128
	EditRate	48/1

A.2.172. 2K 48fps Scope Subtitle Test - Timed Text track file - Reel 5

Type	MXF text	
Filename	sub_test_48fps_scope_04_tt_ct.mxf	
Description	Encrypted MXF track file containing timed text test content.	
Conforms to	SMPTE-377-1, SMPTE-428-7, SMPTE-429-5, SMPTE-429-6	
Meta	Duration	00:01:00:00
	Encryption	AES-128
	EditRate	48/1

A.2.173. 2K 48fps Scope Subtitle Test - Timed Text track file - Reel 6

Type	MXF text	
Filename	sub_test_48fps_scope_05_tt_ct.mxf	
Description	Encrypted MXF track file containing timed text test content.	
Conforms to	SMPTE-377-1, SMPTE-428-7, SMPTE-429-5, SMPTE-429-6	
Meta	Duration	00:01:00:00
	Encryption	AES-128
	EditRate	48/1

A.2.174. 2K 48fps Scope Subtitle Test - Timed Text track file - Reel 7

Type	MXF text	
Filename	sub_test_48fps_scope_06_tt_ct.mxf	
Description	Encrypted MXF track file containing timed text test content.	
Conforms to	SMPTE-377-1, SMPTE-428-7, SMPTE-429-5, SMPTE-429-6	
Meta	Duration	00:01:00:00
	Encryption	AES-128
	EditRate	48/1

A.2.175. 2K 48fps Scope Subtitle Test - Timed Text track file - Reel 8

Type	MXF text	
Filename	sub_test_48fps_scope_07_tt_ct.mxf	
Description	Encrypted MXF track file containing timed text test content.	
Conforms to	SMPTE-377-1, SMPTE-428-7, SMPTE-429-5, SMPTE-429-6	
Meta	Duration	00:01:00:00
	Encryption	AES-128
	EditRate	48/1

A.2.176. 2K 48fps Scope Subtitle Test - Timed Text track file - Reel 9

Type	MXF text	
Filename	sub_test_48fps_scope_08_tt_ct.mxf	

Description	Encrypted MXF track file containing timed text test content.	
Conforms to	SMPTE-377-1, SMPTE-428-7, SMPTE-429-5, SMPTE-429-6	
Meta	Duration	00:01:00:00
	Encryption	AES-128
	EditRate	48/1

A.2.177. 2K 48fps Scope Subtitle Test - Timed Text track file - Reel 10

Type	MXF text	
Filename	sub_test_48fps_scope_09_tt_ct.mxf	
Description	Encrypted MXF track file containing timed text test content.	
Conforms to	SMPTE-377-1, SMPTE-428-7, SMPTE-429-5, SMPTE-429-6	
Meta	Duration	00:01:00:00
	Encryption	AES-128
	EditRate	48/1

A.2.178. 2K Flat Subtitle Test - Timed Text track file - Reel 1

Type	MXF text	
Filename	sub_test_2K_flat_00_tt_ct.mxf	
Description	Encrypted MXF track file containing timed text test content.	
Conforms to	SMPTE-377-1, SMPTE-428-7, SMPTE-429-5, SMPTE-429-6	
Meta	Duration	00:01:00:00
	Encryption	AES-128
	EditRate	24/1

A.2.179. 2K Flat Subtitle Test - Timed Text track file - Reel 2

Type	MXF text	
Filename	sub_test_2K_flat_01_tt_ct.mxf	
Description	Encrypted MXF track file containing timed text test content.	
Conforms to	SMPTE-377-1, SMPTE-428-7, SMPTE-429-5, SMPTE-429-6	
Meta	Duration	00:01:00:00

Encryption	AES-128
EditRate	24/1

A.2.180. 2K Flat Subtitle Test - Timed Text track file - Reel 3

Type	MXF text						
Filename	sub_test_2K_flat_02_tt_ct.mxf						
Description	Encrypted MXF track file containing timed text test content.						
Conforms to	SMPTE-377-1, SMPTE-428-7, SMPTE-429-5, SMPTE-429-6						
Meta	<table border="1"> <tr> <td>Duration</td> <td>00:01:00:00</td> </tr> <tr> <td>Encryption</td> <td>AES-128</td> </tr> <tr> <td>EditRate</td> <td>24/1</td> </tr> </table>	Duration	00:01:00:00	Encryption	AES-128	EditRate	24/1
Duration	00:01:00:00						
Encryption	AES-128						
EditRate	24/1						

A.2.181. 2K Flat Subtitle Test - Timed Text track file - Reel 4

Type	MXF text						
Filename	sub_test_2K_flat_03_tt_ct.mxf						
Description	Encrypted MXF track file containing timed text test content.						
Conforms to	SMPTE-377-1, SMPTE-428-7, SMPTE-429-5, SMPTE-429-6						
Meta	<table border="1"> <tr> <td>Duration</td> <td>00:01:00:00</td> </tr> <tr> <td>Encryption</td> <td>AES-128</td> </tr> <tr> <td>EditRate</td> <td>24/1</td> </tr> </table>	Duration	00:01:00:00	Encryption	AES-128	EditRate	24/1
Duration	00:01:00:00						
Encryption	AES-128						
EditRate	24/1						

A.2.182. 2K Flat Subtitle Test - Timed Text track file - Reel 5

Type	MXF text						
Filename	sub_test_2K_flat_04_tt_ct.mxf						
Description	Encrypted MXF track file containing timed text test content.						
Conforms to	SMPTE-377-1, SMPTE-428-7, SMPTE-429-5, SMPTE-429-6						
Meta	<table border="1"> <tr> <td>Duration</td> <td>00:01:00:00</td> </tr> <tr> <td>Encryption</td> <td>AES-128</td> </tr> <tr> <td>EditRate</td> <td>24/1</td> </tr> </table>	Duration	00:01:00:00	Encryption	AES-128	EditRate	24/1
Duration	00:01:00:00						
Encryption	AES-128						
EditRate	24/1						

A.2.183. 2K Flat Subtitle Test - Timed Text track file - Reel 6

Type	MXF text	
Filename	sub_test_2K_flat_05_tt_ct.mxf	
Description	Encrypted MXF track file containing timed text test content.	
Conforms to	SMPTE-377-1, SMPTE-428-7, SMPTE-429-5, SMPTE-429-6	
Meta	Duration	00:01:00:00
	Encryption	AES-128
	EditRate	24/1

A.2.184. 2K Flat Subtitle Test - Timed Text track file - Reel 7

Type	MXF text	
Filename	sub_test_2K_flat_06_tt_ct.mxf	
Description	Encrypted MXF track file containing timed text test content.	
Conforms to	SMPTE-377-1, SMPTE-428-7, SMPTE-429-5, SMPTE-429-6	
Meta	Duration	00:01:00:00
	Encryption	AES-128
	EditRate	24/1

A.2.185. 2K Flat Subtitle Test - Timed Text track file - Reel 8

Type	MXF text	
Filename	sub_test_2K_flat_07_tt_ct.mxf	
Description	Encrypted MXF track file containing timed text test content.	
Conforms to	SMPTE-377-1, SMPTE-428-7, SMPTE-429-5, SMPTE-429-6	
Meta	Duration	00:01:00:00
	Encryption	AES-128
	EditRate	24/1

A.2.186. 2K Flat Subtitle Test - Timed Text track file - Reel 9

Type	MXF text	
Filename	sub_test_2K_flat_08_tt_ct.mxf	

Description	Encrypted MXF track file containing timed text test content.	
Conforms to	SMPTE-377-1, SMPTE-428-7, SMPTE-429-5, SMPTE-429-6	
Meta	Duration	00:01:00:00
	Encryption	AES-128
	EditRate	24/1

A.2.187. 2K Flat Subtitle Test - Timed Text track file - Reel 10

Type	MXF text	
Filename	sub_test_2K_flat_09_tt_ct.mxf	
Description	Encrypted MXF track file containing timed text test content.	
Conforms to	SMPTE-377-1, SMPTE-428-7, SMPTE-429-5, SMPTE-429-6	
Meta	Duration	00:01:00:00
	Encryption	AES-128
	EditRate	24/1

A.2.188. 4K Flat Subtitle Test - Timed Text track file - Reel 8

Type	MXF text	
Filename	sub_test_4K_flat_07_tt_ct.mxf	
Description	Encrypted MXF track file containing timed text test content.	
Conforms to	SMPTE-377-1, SMPTE-428-7, SMPTE-429-5, SMPTE-429-6	
Meta	Duration	00:01:00:00
	Encryption	AES-128
	EditRate	24/1

A.2.189. 4K Flat Subtitle Test - Timed Text track file - Reel 9

Type	MXF text	
Filename	sub_test_4K_flat_08_tt_ct.mxf	
Description	Encrypted MXF track file containing timed text test content.	
Conforms to	SMPTE-377-1, SMPTE-428-7, SMPTE-429-5, SMPTE-429-6	
Meta	Duration	00:01:00:00

Encryption	AES-128
EditRate	24/1

A.2.190. 2K 48fps Flat Subtitle Test - Timed Text track file - Reel 1

Type	MXF text						
Filename	sub_test_48fps_flat_00_tt_ct.mxf						
Description	Encrypted MXF track file containing timed text test content.						
Conforms to	SMPTE-377-1, SMPTE-428-7, SMPTE-429-5, SMPTE-429-6						
Meta	<table border="1"> <tr> <td>Duration</td> <td>00:01:00:00</td> </tr> <tr> <td>Encryption</td> <td>AES-128</td> </tr> <tr> <td>EditRate</td> <td>48/1</td> </tr> </table>	Duration	00:01:00:00	Encryption	AES-128	EditRate	48/1
Duration	00:01:00:00						
Encryption	AES-128						
EditRate	48/1						

A.2.191. 2K 48fps Flat Subtitle Test - Timed Text track file - Reel 2

Type	MXF text						
Filename	sub_test_48fps_flat_01_tt_ct.mxf						
Description	Encrypted MXF track file containing timed text test content.						
Conforms to	SMPTE-377-1, SMPTE-428-7, SMPTE-429-5, SMPTE-429-6						
Meta	<table border="1"> <tr> <td>Duration</td> <td>00:01:00:00</td> </tr> <tr> <td>Encryption</td> <td>AES-128</td> </tr> <tr> <td>EditRate</td> <td>48/1</td> </tr> </table>	Duration	00:01:00:00	Encryption	AES-128	EditRate	48/1
Duration	00:01:00:00						
Encryption	AES-128						
EditRate	48/1						

A.2.192. 2K 48fps Flat Subtitle Test - Timed Text track file - Reel 3

Type	MXF text						
Filename	sub_test_48fps_flat_02_tt_ct.mxf						
Description	Encrypted MXF track file containing timed text test content.						
Conforms to	SMPTE-377-1, SMPTE-428-7, SMPTE-429-5, SMPTE-429-6						
Meta	<table border="1"> <tr> <td>Duration</td> <td>00:01:00:00</td> </tr> <tr> <td>Encryption</td> <td>AES-128</td> </tr> <tr> <td>EditRate</td> <td>48/1</td> </tr> </table>	Duration	00:01:00:00	Encryption	AES-128	EditRate	48/1
Duration	00:01:00:00						
Encryption	AES-128						
EditRate	48/1						

A.2.193. 2K 48fps Flat Subtitle Test - Timed Text track file - Reel 4

Type	MXF text	
Filename	sub_test_48fps_flat_03_tt_ct.mxf	
Description	Encrypted MXF track file containing timed text test content.	
Conforms to	SMPTE-377-1, SMPTE-428-7, SMPTE-429-5, SMPTE-429-6	
Meta	Duration	00:01:00:00
	Encryption	AES-128
	EditRate	48/1

A.2.194. 2K 48fps Flat Subtitle Test - Timed Text track file - Reel 5

Type	MXF text	
Filename	sub_test_48fps_flat_04_tt_ct.mxf	
Description	Encrypted MXF track file containing timed text test content.	
Conforms to	SMPTE-377-1, SMPTE-428-7, SMPTE-429-5, SMPTE-429-6	
Meta	Duration	00:01:00:00
	Encryption	AES-128
	EditRate	48/1

A.2.195. 2K 48fps Flat Subtitle Test - Timed Text track file - Reel 6

Type	MXF text	
Filename	sub_test_48fps_flat_05_tt_ct.mxf	
Description	Encrypted MXF track file containing timed text test content.	
Conforms to	SMPTE-377-1, SMPTE-428-7, SMPTE-429-5, SMPTE-429-6	
Meta	Duration	00:01:00:00
	Encryption	AES-128
	EditRate	48/1

A.2.196. 2K 48fps Flat Subtitle Test - Timed Text track file - Reel 7

Type	MXF text	
Filename	sub_test_48fps_flat_06_tt_ct.mxf	

Description	Encrypted MXF track file containing timed text test content.	
Conforms to	SMPTE-377-1, SMPTE-428-7, SMPTE-429-5, SMPTE-429-6	
Meta	Duration	00:01:00:00
	Encryption	AES-128
	EditRate	48/1

A.2.197. 2K 48fps Flat Subtitle Test - Timed Text track file - Reel 8

Type	MXF text	
Filename	sub_test_48fps_flat_07_tt_ct.mxf	
Description	Encrypted MXF track file containing timed text test content.	
Conforms to	SMPTE-377-1, SMPTE-428-7, SMPTE-429-5, SMPTE-429-6	
Meta	Duration	00:01:00:00
	Encryption	AES-128
	EditRate	48/1

A.2.198. 2K 48fps Flat Subtitle Test - Timed Text track file - Reel 9

Type	MXF text	
Filename	sub_test_48fps_flat_08_tt_ct.mxf	
Description	Encrypted MXF track file containing timed text test content.	
Conforms to	SMPTE-377-1, SMPTE-428-7, SMPTE-429-5, SMPTE-429-6	
Meta	Duration	00:01:00:00
	Encryption	AES-128
	EditRate	48/1

A.2.199. 2K 48fps Flat Subtitle Test - Timed Text track file - Reel 10

Type	MXF text	
Filename	sub_test_48fps_flat_09_tt_ct.mxf	
Description	Encrypted MXF track file containing timed text test content.	
Conforms to	SMPTE-377-1, SMPTE-428-7, SMPTE-429-5, SMPTE-429-6	
Meta	Duration	00:01:00:00

Encryption	AES-128
EditRate	48/1

A.2.200. 2K Full Subtitle Test - Timed Text track file - Reel 1

Type	MXF text	
Filename	sub_test_2K_full_00_tt_ct.mxf	
Description	Encrypted MXF track file containing timed text test content.	
Conforms to	SMPTE-377-1, SMPTE-428-7, SMPTE-429-5, SMPTE-429-6	
Meta	Duration	00:01:00:00
	Encryption	AES-128
	EditRate	24/1

A.2.201. 2K Full Subtitle Test - Timed Text track file - Reel 2

Type	MXF text	
Filename	sub_test_2K_full_01_tt_ct.mxf	
Description	Encrypted MXF track file containing timed text test content.	
Conforms to	SMPTE-377-1, SMPTE-428-7, SMPTE-429-5, SMPTE-429-6	
Meta	Duration	00:01:00:00
	Encryption	AES-128
	EditRate	24/1

A.2.202. 2K Full Subtitle Test - Timed Text track file - Reel 3

Type	MXF text	
Filename	sub_test_2K_full_02_tt_ct.mxf	
Description	Encrypted MXF track file containing timed text test content.	
Conforms to	SMPTE-377-1, SMPTE-428-7, SMPTE-429-5, SMPTE-429-6	
Meta	Duration	00:01:00:00
	Encryption	AES-128
	EditRate	24/1

A.2.203. 2K Full Subtitle Test - Timed Text track file - Reel 4

Type	MXF text	
Filename	sub_test_2K_full_03_tt_ct.mxf	
Description	Encrypted MXF track file containing timed text test content.	
Conforms to	SMPTE-377-1, SMPTE-428-7, SMPTE-429-5, SMPTE-429-6	
Meta	Duration	00:01:00:00
	Encryption	AES-128
	EditRate	24/1

A.2.204. 2K Full Subtitle Test - Timed Text track file - Reel 5

Type	MXF text	
Filename	sub_test_2K_full_04_tt_ct.mxf	
Description	Encrypted MXF track file containing timed text test content.	
Conforms to	SMPTE-377-1, SMPTE-428-7, SMPTE-429-5, SMPTE-429-6	
Meta	Duration	00:01:00:00
	Encryption	AES-128
	EditRate	24/1

A.2.205. 2K Full Subtitle Test - Timed Text track file - Reel 6

Type	MXF text	
Filename	sub_test_2K_full_05_tt_ct.mxf	
Description	Encrypted MXF track file containing timed text test content.	
Conforms to	SMPTE-377-1, SMPTE-428-7, SMPTE-429-5, SMPTE-429-6	
Meta	Duration	00:01:00:00
	Encryption	AES-128
	EditRate	24/1

A.2.206. 2K Full Subtitle Test - Timed Text track file - Reel 7

Type	MXF text	
Filename	sub_test_2K_full_06_tt_ct.mxf	

Description	Encrypted MXF track file containing timed text test content.	
Conforms to	SMPTE-377-1, SMPTE-428-7, SMPTE-429-5, SMPTE-429-6	
Meta	Duration	00:01:00:00
	Encryption	AES-128
	EditRate	24/1

A.2.207. 2K Full Subtitle Test - Timed Text track file - Reel 8

Type	MXF text	
Filename	sub_test_2K_full_07_tt_ct.mxf	
Description	Encrypted MXF track file containing timed text test content.	
Conforms to	SMPTE-377-1, SMPTE-428-7, SMPTE-429-5, SMPTE-429-6	
Meta	Duration	00:01:00:00
	Encryption	AES-128
	EditRate	24/1

A.2.208. 2K Full Subtitle Test - Timed Text track file - Reel 9

Type	MXF text	
Filename	sub_test_2K_full_08_tt_ct.mxf	
Description	Encrypted MXF track file containing timed text test content.	
Conforms to	SMPTE-377-1, SMPTE-428-7, SMPTE-429-5, SMPTE-429-6	
Meta	Duration	00:01:00:00
	Encryption	AES-128
	EditRate	24/1

A.2.209. 2K Full Subtitle Test - Timed Text track file - Reel 10

Type	MXF text	
Filename	sub_test_2K_full_09_tt_ct.mxf	
Description	Encrypted MXF track file containing timed text test content.	
Conforms to	SMPTE-377-1, SMPTE-428-7, SMPTE-429-5, SMPTE-429-6	
Meta	Duration	00:01:00:00

Encryption	AES-128
EditRate	24/1

A.2.210. 4K Full Subtitle Test - Timed Text track file - Reel 8

Type	MXF text	
Filename	sub_test_4K_full_07_tt_ct.mxf	
Description	Encrypted MXF track file containing timed text test content.	
Conforms to	SMPTE-377-1, SMPTE-428-7, SMPTE-429-5, SMPTE-429-6	
Meta	Duration	00:01:00:00
	Encryption	AES-128
	EditRate	24/1

A.2.211. 4K Full Subtitle Test - Timed Text track file - Reel 9

Type	MXF text	
Filename	sub_test_4K_full_08_tt_ct.mxf	
Description	Encrypted MXF track file containing timed text test content.	
Conforms to	SMPTE-377-1, SMPTE-428-7, SMPTE-429-5, SMPTE-429-6	
Meta	Duration	00:01:00:00
	Encryption	AES-128
	EditRate	24/1

A.2.212. 2K 48fps Full Subtitle Test - Timed Text track file - Reel 1

Type	MXF text	
Filename	sub_test_48fps_full_00_tt_ct.mxf	
Description	Encrypted MXF track file containing timed text test content.	
Conforms to	SMPTE-377-1, SMPTE-428-7, SMPTE-429-5, SMPTE-429-6	
Meta	Duration	00:01:00:00
	Encryption	AES-128
	EditRate	48/1

A.2.213. 2K 48fps Full Subtitle Test - Timed Text track file - Reel 2

Type	MXF text	
Filename	sub_test_48fps_full_01_tt_ct.mxf	
Description	Encrypted MXF track file containing timed text test content.	
Conforms to	SMPTE-377-1, SMPTE-428-7, SMPTE-429-5, SMPTE-429-6	
Meta	Duration	00:01:00:00
	Encryption	AES-128
	EditRate	48/1

A.2.214. 2K 48fps Full Subtitle Test - Timed Text track file - Reel 3

Type	MXF text	
Filename	sub_test_48fps_full_02_tt_ct.mxf	
Description	Encrypted MXF track file containing timed text test content.	
Conforms to	SMPTE-377-1, SMPTE-428-7, SMPTE-429-5, SMPTE-429-6	
Meta	Duration	00:01:00:00
	Encryption	AES-128
	EditRate	48/1

A.2.215. 2K 48fps Full Subtitle Test - Timed Text track file - Reel 4

Type	MXF text	
Filename	sub_test_48fps_full_03_tt_ct.mxf	
Description	Encrypted MXF track file containing timed text test content.	
Conforms to	SMPTE-377-1, SMPTE-428-7, SMPTE-429-5, SMPTE-429-6	
Meta	Duration	00:01:00:00
	Encryption	AES-128
	EditRate	48/1

A.2.216. 2K 48fps Full Subtitle Test - Timed Text track file - Reel 5

Type	MXF text	
Filename	sub_test_48fps_full_04_tt_ct.mxf	

Description	Encrypted MXF track file containing timed text test content.	
Conforms to	SMPTE-377-1, SMPTE-428-7, SMPTE-429-5, SMPTE-429-6	
Meta	Duration	00:01:00:00
	Encryption	AES-128
	EditRate	48/1

A.2.217. 2K 48fps Full Subtitle Test - Timed Text track file - Reel 6

Type	MXF text	
Filename	sub_test_48fps_full_05_tt_ct.mxf	
Description	Encrypted MXF track file containing timed text test content.	
Conforms to	SMPTE-377-1, SMPTE-428-7, SMPTE-429-5, SMPTE-429-6	
Meta	Duration	00:01:00:00
	Encryption	AES-128
	EditRate	48/1

A.2.218. 2K 48fps Full Subtitle Test - Timed Text track file - Reel 7

Type	MXF text	
Filename	sub_test_48fps_full_06_tt_ct.mxf	
Description	Encrypted MXF track file containing timed text test content.	
Conforms to	SMPTE-377-1, SMPTE-428-7, SMPTE-429-5, SMPTE-429-6	
Meta	Duration	00:01:00:00
	Encryption	AES-128
	EditRate	48/1

A.2.219. 2K 48fps Full Subtitle Test - Timed Text track file - Reel 8

Type	MXF text	
Filename	sub_test_48fps_full_07_tt_ct.mxf	
Description	Encrypted MXF track file containing timed text test content.	
Conforms to	SMPTE-377-1, SMPTE-428-7, SMPTE-429-5, SMPTE-429-6	
Meta	Duration	00:01:00:00

Encryption	AES-128
EditRate	48/1

A.2.220. 2K 48fps Full Subtitle Test - Timed Text track file - Reel 9

Type	MXF text						
Filename	sub_test_48fps_full_08_tt_ct.mxf						
Description	Encrypted MXF track file containing timed text test content.						
Conforms to	SMPTE-377-1, SMPTE-428-7, SMPTE-429-5, SMPTE-429-6						
Meta	<table border="0"> <tr> <td>Duration</td> <td>00:01:00:00</td> </tr> <tr> <td>Encryption</td> <td>AES-128</td> </tr> <tr> <td>EditRate</td> <td>48/1</td> </tr> </table>	Duration	00:01:00:00	Encryption	AES-128	EditRate	48/1
Duration	00:01:00:00						
Encryption	AES-128						
EditRate	48/1						

A.2.221. 2K 48fps Full Subtitle Test - Timed Text track file - Reel 10

Type	MXF text						
Filename	sub_test_48fps_full_09_tt_ct.mxf						
Description	Encrypted MXF track file containing timed text test content.						
Conforms to	SMPTE-377-1, SMPTE-428-7, SMPTE-429-5, SMPTE-429-6						
Meta	<table border="0"> <tr> <td>Duration</td> <td>00:01:00:00</td> </tr> <tr> <td>Encryption</td> <td>AES-128</td> </tr> <tr> <td>EditRate</td> <td>48/1</td> </tr> </table>	Duration	00:01:00:00	Encryption	AES-128	EditRate	48/1
Duration	00:01:00:00						
Encryption	AES-128						
EditRate	48/1						

A.2.222. Sync Count with Subtitle Reticles

Type	MXF j2c		
Filename	sync_count_with_subs_j2c_pt.mxf		
Description	MXF track file containing five seconds (120 frames) of plain frames with reticles. followed by a ten second countdown and five seconds of plain frames with subtitle reticles. The countdown consists of ten identical one-second count segments, from 9-0. Each count segment consists of twenty-four frames of the respective digit for the count period. The first frame of each count segment will have a punch set to indicate sync. The example image below shows the first frame of the fourth count period, which contains the number 6 (six).		
Conforms to	SMPTE-377-1, SMPTE-422, SMPTE-429-3, SMPTE-429-4		
Meta	<table border="0"> <tr> <td>Duration</td> <td>00:00:20:00</td> </tr> </table>	Duration	00:00:20:00
Duration	00:00:20:00		

PixelArraySize	2048x1080
EditRate	24/1

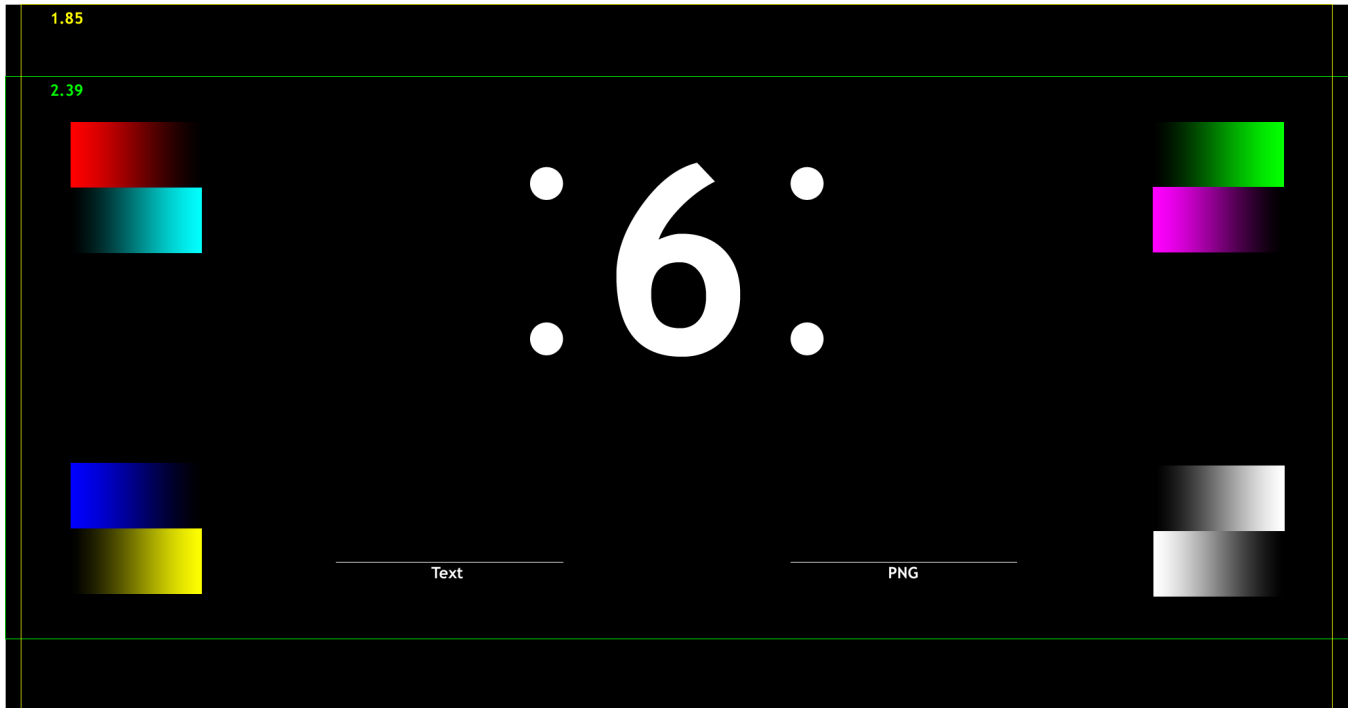

Figure A.2.222.Sync Count with Subtitle Reticles

A.2.223. Sync Count with Subtitle Reticles (Encrypted)

Type	MXF j2c	
Filename	sync_count_with_subs_j2c_ct.mxf	
Description	Encrypted MXF track file, contents are identical to Section A.2.222: Sync Count with Subtitle Reticles .	
Conforms to	SMPTE-377-1, SMPTE-422, SMPTE-429-3, SMPTE-429-4, SMPTE-429-6	
Meta	Encryption	AES-128
	Duration	00:00:20:00
	PixelArraySize	2048x1080
	EditRate	24/1

A.2.224. StEM 2K Multi-Reel C (Encrypted)

Type	MXF j2c multi
Filename	StEM_2K_j2c_multi_C_ct_<segment>.mxf

Description	A set of encrypted MXF track files containing 2k image essence for the DCI StEM Mini Movie. 64 files, each with a duration of 1 second.
Conforms to	SMPTE-377-1, SMPTE-422, SMPTE-429-3, SMPTE-429-4, SMPTE-429-6
Meta	<p>SegmentCount 64</p> <p>Encryption AES-128</p> <p>SegmentDuration 00:01:00</p> <p>Duration 00:01:04:00</p> <p>PixelArraySize 2048x858</p> <p>EditRate 24/1</p>

A.2.225. M25 Picture Track File with Malformed Integrity Pack: Missing MIC item (Encrypted)

Type	MXF j2c
Filename	m25_integrity_pict_mic_j2c_ct.mxf
Description	Encrypted MXF track file, contents are identical to <i>Sync Count</i> but the 1,441th edit unit is missing the MIC item.
Conforms to	SMPTE-377-1, SMPTE-422, SMPTE-429-3, SMPTE-429-4, SMPTE-429-6
Malformations	The 1,441th edit unit is missing the MIC item

A.2.226. M27 Picture Track File with Malformed Integrity Pack: Missing TrackFileID item (Encrypted)

Type	MXF j2c
Filename	m27_integrity_pict_tfid_j2c_ct.mxf
Description	Encrypted MXF track file, contents are identical to <i>Sync Count</i> but the 1,441th edit unit is missing the TrackFileID item.
Conforms to	SMPTE-377-1, SMPTE-422, SMPTE-429-3, SMPTE-429-4, SMPTE-429-6
Malformations	The 1,441th edit unit is missing the TrackFileID item

A.2.227. M26 Picture Track File with Malformed Integrity Pack: Missing SequenceNumber item (Encrypted)

Type	MXF j2c
Filename	m26_integrity_pict_snum_j2c_ct.mxf
Description	Encrypted MXF track file, contents are identical to <i>Sync Count</i> but the 1,441th edit unit is missing the SequenceNumber item.

Conforms to	SMPTE-377-1, SMPTE-422, SMPTE-429-3, SMPTE-429-4, SMPTE-429-6
Malformations	The 1,441th edit unit is missing the SequenceNumber item

A.2.228. Deleted Section

The section "Sync Count with KDM-Borne MIC Key" was deleted. The section number is maintained here to preserve the numbering of subsequent sections.

A.2.229. Sync Count with KDM-Borne MIC Key (Encrypted)

Type	MXF j2c mkey
Filename	sync_count_j2c_mkey_ct.mxf
Description	Encrypted MXF track file, contents are identical to A.2.2. Sync Count but with KDM-borne MIC Keys.
Conforms to	SMPTE-377-1, SMPTE-422, SMPTE-429-3, SMPTE-429-4, SMPTE-429-6

A.2.230. OBAE Rendering Expectations Guide

Type	MXF j2c mkey
Filename	obae_render_test_j2c_pt.mxf
Description	MXF track file whose image contents illustrates the expected acoustic output resulting from the rendering of A.3.90. OBAE Rendering Test .
Conforms to	SMPTE-377-1, SMPTE-422, SMPTE-429-3, SMPTE-429-4, SMPTE-429-6

A.2.231. HDR Sequential Contrast Sequence

Type	MXF j2c
Filename	4K_sequential_contrast_hdr_j2c_pt.mxf
Description	MXF track file containing black (X''= 60, Y'' = 62, Z'' = 65), white (X''= 2524, Y''= 2546, Z''= 2583) and aiming target HDR 4K frames.
Conforms to	[SMPTE-377-1], [SMPTE-422], [SMPTE-429-3], [SMPTE-429-4], [DCI-HDR]

A.2.232. 4K HDR Color Accuracy Series

Type	MXF j2c
Filename	4K_sequential_color_hdr_j2c_pt.mxf
Description	MXF track file containing five seconds (120 frames) of a chart illustrating all Color Accuracy Color Patch Code Values specified in [DCI-HDR]. This is followed by 1 minute of each of the Code Values as a full frame.
Conforms to	[SMPTE-377-1], [SMPTE-422], [SMPTE-429-3], [SMPTE-429-4], [DCI-HDR]

A.2.233. 2K Full SDR Black

Type	MXF j2c
Filename	2k_full_sdr_black_j2c_pt.mxf
Description	Image Track File that contains 1 minute of 2K full frames, each filled with pixels with code value (X'=0, Y'=0, Z'=0).
Conforms to	[SMPTE-377-1], [SMPTE-422], [SMPTE-429-3], [SMPTE-429-4]

A.2.234. 2K Scope SDR Black

Type	MXF j2c
Filename	2k_scope_sdr_black_j2c_pt.mxf
Description	Image Track File that contains 1 minute of 2K scope frames, each filled with pixels with code value (X'=0, Y'=0, Z'=0).
Conforms to	[SMPTE-377-1], [SMPTE-422], [SMPTE-429-3], [SMPTE-429-4]

A.2.235. 2K Flat SDR Black

Type	MXF j2c
Filename	2k_flat_sdr_black_j2c_pt.mxf
Description	Image Track File that contains 1 minute of 2K flat frames, each filled with pixels with code value (X'=0, Y'=0, Z'=0).
Conforms to	[SMPTE-377-1], [SMPTE-422], [SMPTE-429-3], [SMPTE-429-4]

A.2.236. 4K Full SDR Black

Type	MXF j2c
Filename	4k_full_sdr_black_j2c_pt.mxf
Description	Image Track File that contains 1 minute of 4K full frames, each filled with pixels with code value (X'=0, Y'=0, Z'=0).
Conforms to	[SMPTE-377-1], [SMPTE-422], [SMPTE-429-3], [SMPTE-429-4]

A.2.237. 4K Scope SDR Black

Type	MXF j2c
Filename	4k_scope_sdr_black_j2c_pt.mxf
Description	Image Track File that contains 1 minute of 4K scope frames, each filled with pixels with code value (X'=0, Y'=0, Z'=0).

Conforms to	[SMPTE-377-1], [SMPTE-422], [SMPTE-429-3], [SMPTE-429-4]
--------------------	--

A.2.238. 4K Flat SDR Black

Type	MXF j2c
Filename	4k_flat_sdr_black_j2c_pt.mxf
Description	Image Track File that contains 1 minute of 4K flat frames, each filled with pixels with code value (X'=0, Y'=0, Z'=0).
Conforms to	[SMPTE-377-1], [SMPTE-422], [SMPTE-429-3], [SMPTE-429-4]

A.2.239. 2K Full SDR Black with Marks

Type	MXF j2c
Filename	2k_full_sdr_black_marks_j2c_pt.mxf
Description	Image Track File that contains 1 minute of 2K full frames, each filled with pixels with code value (X'=0, Y'=0, Z'=0), with the exception of registration marks at each corner of the frame that use pixels with code value (X'=122, Y'=128, Z'=125), as illustrated at Figure A.2.239 .
Conforms to	[SMPTE-377-1], [SMPTE-422], [SMPTE-429-3], [SMPTE-429-4]



Figure A.2.239. Black frame with registration marks (not to scale)

A.2.240. 2K Scope SDR Black with Marks

Type	MXF j2c
Filename	2k_scope_sdr_black_marks_j2c_pt.mxf
Description	Image Track File that contains 1 minute of 2K scope frames, each filled with pixels with code value (X'=0, Y'=0, Z'=0), with the exception of registration marks at each corner of the frame that use pixels with code value (X'=122, Y'=128, Z'=125), as illustrated at Figure A.2.239 .
Conforms to	[SMPTE-377-1], [SMPTE-422], [SMPTE-429-3], [SMPTE-429-4]

A.2.241. 2K Flat SDR Black with Marks

Type	MXF j2c
Filename	2k_flat_sdr_black_marks_j2c_pt.mxf
Description	Image Track File that contains 1 minute of 2K flat frames, each filled with pixels with code value ($X'=0$, $Y'=0$, $Z'=0$), with the exception of registration marks at each corner of the frame that use pixels with code value ($X'=122$, $Y'=128$, $Z'=125$), as illustrated at Figure A.2.239 .
Conforms to	[SMPTE-377-1], [SMPTE-422], [SMPTE-429-3], [SMPTE-429-4]

A.2.242. 4K Full SDR Black with Marks

Type	MXF j2c
Filename	4k_full_sdr_black_marks_j2c_pt.mxf
Description	Image Track File that contains 1 minute of 4K full frames, each filled with pixels with code value ($X'=0$, $Y'=0$, $Z'=0$), with the exception of registration marks at each corner of the frame that use pixels with code value ($X'=122$, $Y'=128$, $Z'=125$), as illustrated at Figure A.2.239 .
Conforms to	[SMPTE-377-1], [SMPTE-422], [SMPTE-429-3], [SMPTE-429-4]

A.2.243. 4K Scope SDR Black with Marks

Type	MXF j2c
Filename	4k_scope_sdr_black_marks_j2c_pt.mxf
Description	Image Track File that contains 1 minute of 4K scope frames, each filled with pixels with code value ($X'=0$, $Y'=0$, $Z'=0$), with the exception of registration marks at each corner of the frame that use pixels with code value ($X'=122$, $Y'=128$, $Z'=125$), as illustrated at Figure A.2.239 .
Conforms to	[SMPTE-377-1], [SMPTE-422], [SMPTE-429-3], [SMPTE-429-4]

A.2.244. 4K Flat SDR Black with Marks

Type	MXF j2c
Filename	4k_flat_sdr_black_marks_j2c_pt.mxf
Description	Image Track File that contains 1 minute of 4K flat frames, each filled with pixels with code value ($X'=0$, $Y'=0$, $Z'=0$), with the exception of registration marks at each corner of the frame that use pixels with code value ($X'=122$, $Y'=128$, $Z'=125$), as illustrated at Figure A.2.239 .
Conforms to	[SMPTE-377-1], [SMPTE-422], [SMPTE-429-3], [SMPTE-429-4]

A.2.245. 2K Full SDR Black with Active Area

Type	MXF j2c
Filename	2k_full_sdr_black_active_j2c_pt.mxf

Description	Image Track File that contains 1 minute of 2K flat frames. Each frame, illustrated at Figure A.2.245 , consists of a central rectangular area with dimensions (1440×1080) filled with code value (X'=0, Y'=0, Z'=0). The rest of the frame is filled with code value (X'= 2901, Y'=2171, Z'=100). Registration marks with code value (X'=122, Y'=128, Z'=125) are located at all four corners of the central rectangular area.
Conforms to	[SMPTE-377-1], [SMPTE-422], [SMPTE-429-3], [SMPTE-429-4]



Figure A.2.245. Frame with an active area (not to scale)

A.2.246. 2K Scope SDR Black with Active Area

Type	MXF j2c
Filename	2k_scope_sdr_black_active_j2c_pt.mxf
Description	Image Track File that contains 1 minute of 2K scope frames. Each frame, illustrated at Figure A.2.245 , consists of a central rectangular area with dimensions (2048×768) filled with code value (X'=0, Y'=0, Z'=0). The rest of the frame is filled with code value (X'= 2901, Y'=2171, Z'=100). Registration marks with code value (X'=122, Y'=128, Z'=125) are located at all four corners of the central rectangular area.
Conforms to	[SMPTE-377-1], [SMPTE-422], [SMPTE-429-3], [SMPTE-429-4]

A.2.247. 2K Flat SDR Black with Active Area

Type	MXF j2c
Filename	2k_flat_sdr_black_active_j2c_pt.mxf
Description	Image Track File that contains 1 minute of 2K flat frames. Each frame, illustrated at Figure A.2.245 , consists of a central rectangular area with dimensions (1998×998) filled with code value (X'=0, Y'=0, Z'=0). The rest of the frame is filled with code value (X'= 2901, Y'=2171, Z'=100). Registration marks with code value (X'=122, Y'=128, Z'=125) are located at all four corners of the central rectangular area.
Conforms to	[SMPTE-377-1], [SMPTE-422], [SMPTE-429-3], [SMPTE-429-4]

A.2.248. 4K Full SDR Black with Active Area

Type	MXF j2c
Filename	4k_full_sdr_black_active_j2c_pt.mxf
Description	Image Track File that contains 1 minute of 4K full frames. Each frame, illustrated at Figure A.2.245, consists of a central rectangular area with dimensions (2880×2160) filled with code value (X'=0, Y'=0, Z'=0). The rest of the frame is filled with code value (X'= 2901, Y'=2171, Z'=100). Registration marks with code value (X'=122, Y'=128, Z'=125) are located at all four corners of the central rectangular area.
Conforms to	[SMPTE-377-1], [SMPTE-422], [SMPTE-429-3], [SMPTE-429-4]

A.2.249. 4K Scope SDR Black with Active Area

Type	MXF j2c
Filename	4k_scope_sdr_black_active_j2c_pt.mxf
Description	Image Track File that contains 1 minute of 4K scope frames. Each frame, illustrated at Figure A.2.245, consists of a central rectangular area with dimensions (4096×1536) filled with code value (X'=0, Y'=0, Z'=0). The rest of the frame is filled with code value (X'= 2901, Y'=2171, Z'=100). Registration marks with code value (X'=122, Y'=128, Z'=125) are located at all four corners of the central rectangular area.
Conforms to	[SMPTE-377-1], [SMPTE-422], [SMPTE-429-3], [SMPTE-429-4]

A.2.250. 4K Flat SDR Black with Active Area

Type	MXF j2c
Filename	4k_flat_sdr_black_active_j2c_pt.mxf
Description	Image Track File that contains 1 minute of 4K flat frames. Each frame, illustrated at Figure A.2.245, consists of a central rectangular area with dimensions (3996×1996) filled with code value (X'=0, Y'=0, Z'=0). The rest of the frame is filled with code value (X'= 2901, Y'=2171, Z'=100). Registration marks with code value (X'=122, Y'=128, Z'=125) are located at all four corners of the central rectangular area.
Conforms to	[SMPTE-377-1], [SMPTE-422], [SMPTE-429-3], [SMPTE-429-4]

A.2.251. SDR Stereoscopic Contrast Test Patterns

Type	MXF j2c
Filename	2k_full_sdr_contrast_stereo_j2c_pt.mxf
Description	Image Track File that consists of the sequence of test patterns specified in the <i>stereoscopic extinction ratio & crosstalk</i> and <i>stereoscopic luminance & luminance difference</i> procedures at [ICDM IDMS]: black for left eye and white for right eye, white for left eye and black for right eye, black for both eyes, white for both eyes Each pattern is displayed for 10s and is preceded by a card that is displayed for 3s and contains a description of the pattern, e.g. <i>test pattern with black for left eye and white for right eye</i> . The white pattern is D65 full screen white at 48 cd/m ² (X' = 3883, Y' = 3960, Z' = 4092). The black pattern is zero-signal black (X'=0, Y'=0, Z'=0).

Conforms to [SMPTE-377-1], [SMPTE-422], [SMPTE-429-3], [SMPTE-429-4], [SMPTE-429-10], [ICDM IDMS]

A.2.252. Stereoscopic Color Accuracy Series

Type	MXF j2c
Filename	color_accuracy_stereo_j2c_pt.mxf
Description	Stereoscopic picture track file containing five seconds (120 frames) of the chart specified at A.2.12. Color Accuracy Series . This is followed by 1 minute of each of the 12 color values as a full frame. There is no disparity between the two eyes.
Conforms to	SMPTE-377-1, SMPTE-422, SMPTE-429-3, SMPTE-429-4, SMPTE-429-10, SMPTE-431-2

A.2.253. 4K SDR White Lines on Black Background

Type	MXF j2c
Filename	4k_white_lines_j2c_pt.mxf
Description	Image Track File that contains 1 minute of 4K flat frames. Each frame, illustrated at Figure A.2.253 , consists of 3 sets of three patches, with the sets stacked vertically and the patches arranged horizontally. Each set consists one patch with horizontal lines, one patch with vertical lines and one patch with oblique lines. Each patch contains lines that are 1, 2, 3 and 4 pixel-wide, and that are not antialiased. The lines are D65 full screen white and the background is black.
Conforms to	[SMPTE-377-1], [SMPTE-422], [SMPTE-429-3], [SMPTE-429-4]

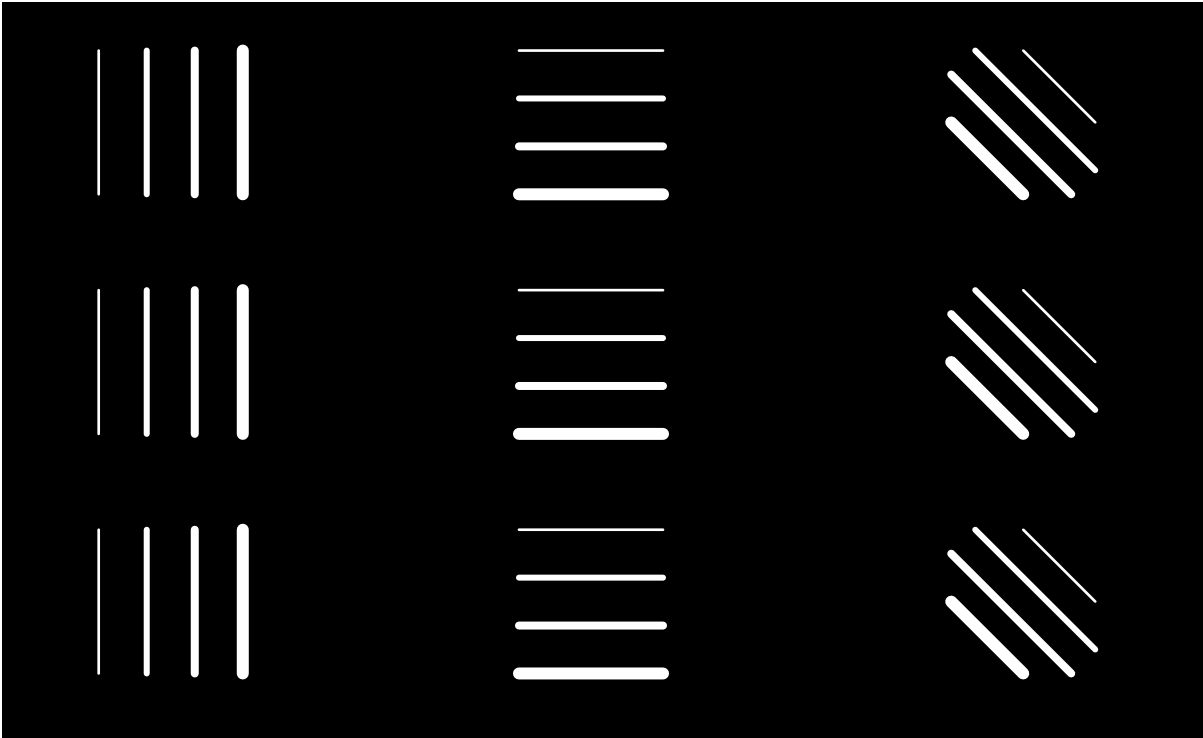

Figure A.2.253. Frame with horizontal, vertical and oblique white lines on a black background (not to scale)

A.2.254. 4K SDR Scaling Test Pattern

Type	MXF j2c
Filename	4k_full_sdr_scaling_j2c_pt.mxf
Description	Image Track File that contains 10s of the 4K frame illustrated at Figure A.2.254 , which consists of: (a) on left side of the frame, continuous 1-pixel line segments at various angles and of various colors and a small gray square; and (b) on the right side of the frame, a zone plate with a wavelength of 2 pixels.
Conforms to	[SMPTE-377-1], [SMPTE-422], [SMPTE-429-3], [SMPTE-429-4]

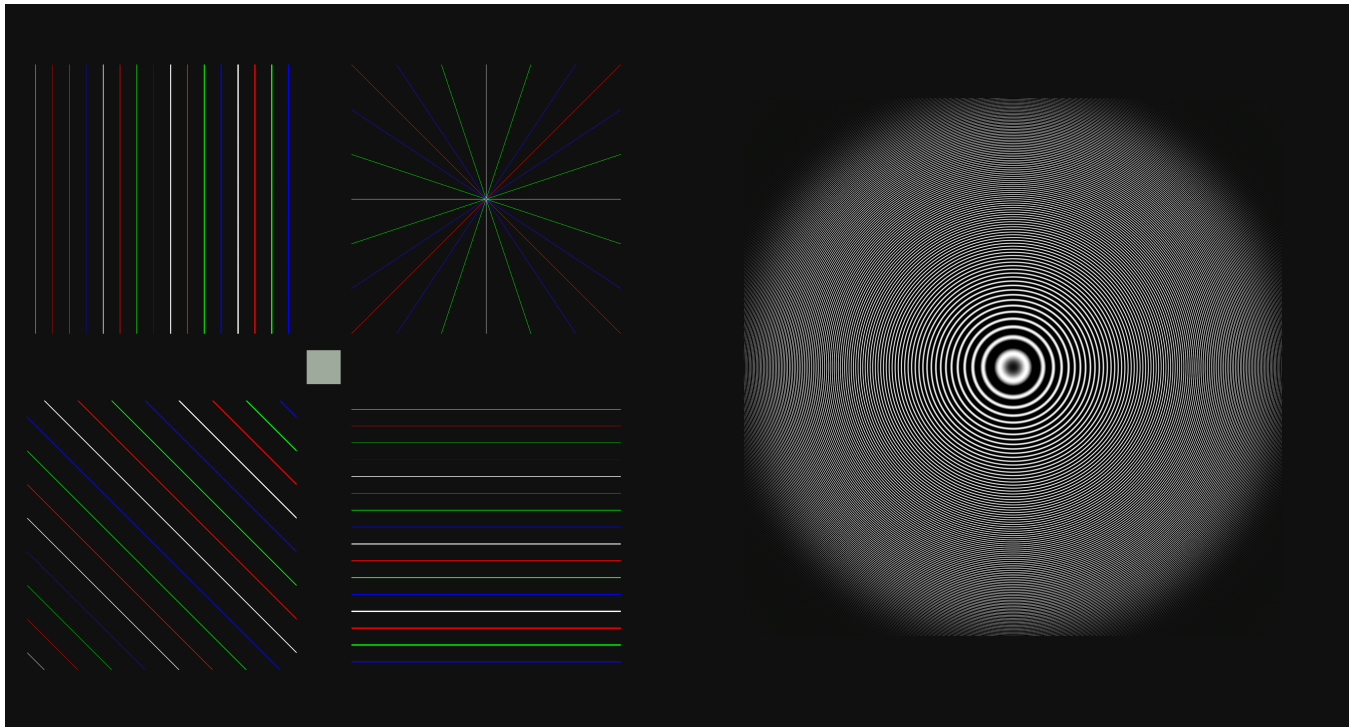

Figure A.2.254. Frame with line segments, uniform gray square and zone plate

A.2.260. HDR Black to Gray Step Series

Type	MXF j2c
Filename	hdr_gray_step_j2c_pt.mxf
Description	MXF track file containing five seconds (120 frames) of a chart showing all gray step values in [DCI-HDR], Table 5. This is followed by 1 minute of each of the 10 values as a full frame. The layout of each frame follows that of A.2.10. Black to Gray Step Series .
Conforms to	SMPTE-377-1, SMPTE-422, SMPTE-429-3, SMPTE-429-4, [DCI-HDR]

A.2.261. HDR Black to White Step Series

Type	MXF j2c
-------------	---------

Filename	hdr_white_step_j2c_pt.mxf
Description	MXF track file containing five seconds (120 frames) of a chart showing all gray step values in [DCI-HDR], Table 4. This is followed by 1 minute of each of the 10 values as a full frame. The layout of each frame follows that of A.2.11. Black to White Step Series .
Conforms to	SMPTE-377-1, SMPTE-422, SMPTE-429-3, SMPTE-429-4, [DCI-HDR]

A.2.262. SDR verification pattern

Type	MXF j2c
Filename	sdr_check_j2c_pt.mxf
Description	MXF track file consisting of the following sequence: (1) 2-second card displaying the word "SDR dark", (2) 10 seconds of a frame filled with code values ($X'=0$, $Y'=0$, $Z'=0$), (3) 2-second card displaying the word "SDR light", and (4) 10 seconds of a frame filled with code values ($X'=2524$, $Y'=2546$, $Z'=2583$).
Conforms to	SMPTE-377-1, SMPTE-422, SMPTE-429-3, SMPTE-429-4

A.2.263. HDR verification pattern

Type	MXF j2c
Filename	hdr_check_j2c_pt.mxf
Description	MXF track file consisting of the following sequence: (1) 2-second card displaying the word "HDR dark", (2) 10 seconds of a frame filled with code values ($X''=60$, $Y''=62$, $Z''=65$), (3) 2-second card displaying the word "HDR light", and (4) 10 seconds of a frame filled with code values ($X''=2524$, $Y''=2546$, $Z''=2583$).
Conforms to	SMPTE-377-1, SMPTE-422, SMPTE-429-3, SMPTE-429-4, [DCI-HDR]

A.2.264. 2K Full HDR Black with Marks

Type	MXF j2c
Filename	2k_full_hdr_black_marks_j2c_pt.mxf
Description	Image Track File that contains 1 minute of 2K full frames, each filled with pixels with code value ($X''=0$, $Y''=0$, $Z''=0$), with the exception of registration marks at each corner of the frame that use pixels with code value ($X''=157$, $Y''=161$, $Z''=167$), as illustrated at Figure A.2.239 .
Conforms to	[SMPTE-377-1], [SMPTE-422], [SMPTE-429-3], [SMPTE-429-4], [DCI-HDR]

A.2.265. 2K Scope HDR Black with Marks

Type	MXF j2c
Filename	2k_scope_hdr_black_marks_j2c_pt.mxf
Description	Image Track File that contains 1 minute of 2K scope frames, each filled with pixels with code value ($X''=0$, $Y''=0$, $Z''=0$), with the exception of registration marks at each corner of the frame that use pixels with code value ($X''=157$, $Y''=161$, $Z''=167$), as illustrated at Figure A.2.239 .

Conforms to	[SMPTE-377-1], [SMPTE-422], [SMPTE-429-3], [SMPTE-429-4], [DCI-HDR]
--------------------	---

A.2.266. 2K Flat HDR Black with Marks

Type	MXF j2c
Filename	2k_flat_hdr_black_marks_j2c_pt.mxf
Description	Image Track File that contains 1 minute of 2K flat frames, each filled with pixels with code value (X''=0, Y''=0, Z''=0), with the exception of registration marks at each corner of the frame that use pixels with code value (X''=157, Y''=161, Z''=167), as illustrated at Figure A.2.239 .
Conforms to	[SMPTE-377-1], [SMPTE-422], [SMPTE-429-3], [SMPTE-429-4], [DCI-HDR]

A.2.267. 4K Full HDR Black with Marks

Type	MXF j2c
Filename	4k_full_hdr_black_marks_j2c_pt.mxf
Description	Image Track File that contains 1 minute of 4K full frames, each filled with pixels with code value (X''=0, Y''=0, Z''=0), with the exception of registration marks at each corner of the frame that use pixels with code value (X''=157, Y''=161, Z''=167), as illustrated at Figure A.2.239 .
Conforms to	[SMPTE-377-1], [SMPTE-422], [SMPTE-429-3], [SMPTE-429-4], [DCI-HDR]

A.2.268. 4K Scope HDR Black with Marks

Type	MXF j2c
Filename	4k_scope_hdr_black_marks_j2c_pt.mxf
Description	Image Track File that contains 1 minute of 4K scope frames, each filled with pixels with code value (X''=0, Y''=0, Z''=0), with the exception of registration marks at each corner of the frame that use pixels with code value (X''=157, Y''=161, Z''=167), as illustrated at Figure A.2.239 .
Conforms to	[SMPTE-377-1], [SMPTE-422], [SMPTE-429-3], [SMPTE-429-4], [DCI-HDR]

A.2.269. 4K Flat HDR Black with Marks

Type	MXF j2c
Filename	4k_flat_hdr_black_marks_j2c_pt.mxf
Description	Image Track File that contains 1 minute of 4K flat frames, each filled with pixels with code value (X''=0, Y''=0, Z''=0), with the exception of registration marks at each corner of the frame that use pixels with code value (X''=157, Y''=161, Z''=167), as illustrated at Figure A.2.239 .
Conforms to	[SMPTE-377-1], [SMPTE-422], [SMPTE-429-3], [SMPTE-429-4], [DCI-HDR]

A.2.270. 2K Full HDR Black with Active Area

Type	MXF j2c
-------------	---------

Filename	2k_full_hdr_black_active_j2c_pt.mxf
Description	Image Track File that contains 1 minute of 4K flat frames. Each frame, illustrated at Figure A.2.245 , consists of a central rectangular area with dimensions (1440×1080) filled with code value (X''=0, Y''=0, Z''=0). The rest of the frame is filled with code value (X''= 2234, Y''=1925, Z''=68). Registration marks with code value (X''=157, Y''=161, Z''=167) are located at all four corners of the central rectangular area.
Conforms to	[SMPTE-377-1], [SMPTE-422], [SMPTE-429-3], [SMPTE-429-4], [DCI-HDR]

A.2.271. 2K Scope HDR Black with Active Area

Type	MXF j2c
Filename	2k_scope_hdr_black_active_j2c_pt.mxf
Description	Image Track File that contains 1 minute of 2K scope frames. Each frame, illustrated at Figure A.2.245 , consists of a central rectangular area with dimensions (2048×768) filled with code value (X''=0, Y''=0, Z''=0). The rest of the frame is filled with code value (X''= 2234, Y''=1925, Z''=68). Registration marks with code value (X''=157, Y''=161, Z''=167) are located at all four corners of the central rectangular area.
Conforms to	[SMPTE-377-1], [SMPTE-422], [SMPTE-429-3], [SMPTE-429-4], [DCI-HDR]

A.2.272. 2K Flat HDR Black with Active Area

Type	MXF j2c
Filename	2k_flat_hdr_black_active_j2c_pt.mxf
Description	Image Track File that contains 1 minute of 2K flat frames. Each frame, illustrated at Figure A.2.245 , consists of a central rectangular area with dimensions (1998×998) filled with code value (X''=0, Y''=0, Z''=0). The rest of the frame is filled with code value (X''= 2234, Y''=1925, Z''=68). Registration marks with code value (X''=157, Y''=161, Z''=167) are located at all four corners of the central rectangular area.
Conforms to	[SMPTE-377-1], [SMPTE-422], [SMPTE-429-3], [SMPTE-429-4], [DCI-HDR]

A.2.273. 4K Full HDR Black with Active Area

Type	MXF j2c
Filename	4k_full_hdr_black_active_j2c_pt.mxf
Description	Image Track File that contains 1 minute of 4K full frames. Each frame, illustrated at Figure A.2.245 , consists of a central rectangular area with dimensions (2880×2160) filled with code value (X''=0, Y''=0, Z''=0). The rest of the frame is filled with code value (X''= 2234, Y''=1925, Z''=68). Registration marks with code value (X''=157, Y''=161, Z''=167) are located at all four corners of the central rectangular area.
Conforms to	[SMPTE-377-1], [SMPTE-422], [SMPTE-429-3], [SMPTE-429-4], [DCI-HDR]

A.2.274. 4K Scope HDR Black with Active Area

Type	MXF j2c
Filename	4k_scope_hdr_black_active_j2c_pt.mxf
Description	Image Track File that contains 1 minute of 4K scope frames. Each frame, illustrated at Figure A.2.245, consists of a central rectangular area with dimensions (4096×1536) filled with code value (X"=0, Y"=0, Z"=0). The rest of the frame is filled with code value (X"= 2234, Y"=1925, Z"=68). Registration marks with code value (X"=157, Y"=161, Z"=167) are located at all four corners of the central rectangular area.
Conforms to	[SMPTE-377-1], [SMPTE-422], [SMPTE-429-3], [SMPTE-429-4], [DCI-HDR]

A.2.275. 4K Flat HDR Black with Active Area

Type	MXF j2c
Filename	4k_flat_hdr_black_active_j2c_pt.mxf
Description	Image Track File that contains 1 minute of 4K flat frames. Each frame, illustrated at Figure A.2.245, consists of a central rectangular area with dimensions (3996×1996) filled with code value (X"=0, Y"=0, Z"=0). The rest of the frame is filled with code value (X"= 2234, Y"=1925, Z"=68). Registration marks with code value (X"=157, Y"=161, Z"=167) are located at all four corners of the central rectangular area.
Conforms to	[SMPTE-377-1], [SMPTE-422], [SMPTE-429-3], [SMPTE-429-4], [DCI-HDR]

A.2.276. 2K 2D 24 FPS Test

Type	MXF j2c
Filename	2k_2d_24_fps_j2c_pt.mxf
Description	Image Track File that contains a 2K 2D image sequence at 24 fps intended to verify that an imaging device displays all images. The image sequence displays a continuously swinging pendulum. Every even and odd frame is labeled even and odd, respectively. Every 1 st , 2 nd , 3 rd , 4 th and 5 th frame is labeled 1, 2, 3, 4 and 5, respectively. A burned-in timecode sequence is displayed in the top-right corner.
Conforms to	[SMPTE-377-1], [SMPTE-422], [SMPTE-429-3], [SMPTE-429-4]

A.2.277. 2K 2D 48 FPS Test

Type	MXF j2c
Filename	2k_2d_48_fps_j2c_pt.mxf
Description	Same as A.2.276. 2K 2D 24 FPS Test but with a 2K 2D image sequence at 48 fps.
Conforms to	[SMPTE-377-1], [SMPTE-422], [SMPTE-429-3], [SMPTE-429-4]

A.2.278. 2K 2D 60 FPS Test

Type	MXF j2c
Filename	2k_2d_60_fps_j2c_pt.mxf

Description	Same as A.2.276. 2K 2D 24 FPS Test but with a 2K 2D image sequence at 60 fps.
Conforms to	[SMPTE-377-1], [SMPTE-422], [SMPTE-429-3], [SMPTE-429-4]

A.2.279. 2K 2D 96 FPS Test

Type	MXF j2c
Filename	2k_2d_96_fps_j2c_pt.mxf
Description	Same as A.2.276. 2K 2D 24 FPS Test but with a 2K 2D image sequence at 96 fps.
Conforms to	[SMPTE-377-1], [SMPTE-422], [SMPTE-429-3], [SMPTE-429-4]

A.2.280. 2K 2D 120 FPS Test

Type	MXF j2c
Filename	2k_2d_120_fps_j2c_pt.mxf
Description	Same as A.2.276. 2K 2D 24 FPS Test but with a 2K 2D image sequence at 120 fps.
Conforms to	[SMPTE-377-1], [SMPTE-422], [SMPTE-429-3], [SMPTE-429-4]

A.2.281. 2K Stereoscopic 24 FPS Test

Type	MXF j2c
Filename	2k_stereo_24_fps_j2c_pt.mxf
Description	Same as A.2.276. 2K 2D 24 FPS Test but with a 2K stereoscopic image sequence at 24 fps, the pendulum popping out of the screen and the words left and right appearing only in the left and right eye, respectively.
Conforms to	[SMPTE-377-1], [SMPTE-422], [SMPTE-429-3], [SMPTE-429-4], [SMPTE-429-10]

A.2.282. 2K Stereoscopic 48 FPS Test

Type	MXF j2c
Filename	2k_stereo_48_fps_j2c_pt.mxf
Description	Same as A.2.281. 2K Stereoscopic 24 FPS Test but with a 2K stereoscopic image sequence at 48 fps.
Conforms to	[SMPTE-377-1], [SMPTE-422], [SMPTE-429-3], [SMPTE-429-4], [SMPTE-429-10]

A.2.283. 2K Stereoscopic 60 FPS Test

Type	MXF j2c
Filename	2k_stereo_60_fps_j2c_pt.mxf
Description	Same as A.2.281. 2K Stereoscopic 24 FPS Test but with a 2K stereoscopic image sequence at 60 fps.

Conforms to	[SMPTE-377-1], [SMPTE-422], [SMPTE-429-3], [SMPTE-429-4], [SMPTE-429-10]
--------------------	--

A.2.284. 4K 2D 24 FPS Test

Type	MXF j2c
Filename	4k_2d_24_fps_j2c_pt.mxf
Description	Same as A.2.276. 2K 2D 24 FPS Test but with a 4K image sequence at 24 fps, and the word 4K visible only if the 4K resolution layer is decoded.
Conforms to	[SMPTE-377-1], [SMPTE-422], [SMPTE-429-3], [SMPTE-429-4]

A.2.285. 4K 2D 48 FPS Test

Type	MXF j2c
Filename	4k_2d_48_fps_j2c_pt.mxf
Description	Same as A.2.284. 4K 2D 24 FPS Test but with a 4K 2D image sequence at 48 fps.
Conforms to	[SMPTE-377-1], [SMPTE-422], [SMPTE-429-3], [SMPTE-429-4]

A.2.286. 4K 2D 60 FPS Test

Type	MXF j2c
Filename	4k_2d_60_fps_j2c_pt.mxf
Description	Same as A.2.284. 4K 2D 24 FPS Test but with a 4K 2D image sequence at 60 fps.
Conforms to	[SMPTE-377-1], [SMPTE-422], [SMPTE-429-3], [SMPTE-429-4]

A.2.287. 24 FPS test timecode

Type	MXF text
Filename	24_fps_test_tt_pt.mxf
Description	MXF track file containing timed text that matches the burned-in timecode at <i>2K 2D 24 FPS Test</i> .
Conforms to	SMPTE-377-1, SMPTE-429-3, SMPTE-429-5

A.2.288. 48 FPS test timecode

Type	MXF text
Filename	48_fps_test_tt_pt.mxf
Description	MXF track file containing timed text that matches the burned-in timecode at <i>2K 2D 48 FPS Test</i> .
Conforms to	SMPTE-377-1, SMPTE-429-3, SMPTE-429-5

A.2.289. 60 FPS test timecode

Type	MXF text
Filename	60_fps_test_tt_pt.mxf
Description	MXF track file containing timed text that matches the burned-in timecode at <i>2K 2D 60 FPS Test</i> .
Conforms to	SMPTE-377-1, SMPTE-429-3, SMPTE-429-5

A.2.290. 96 FPS test timecode

Type	MXF text
Filename	96_fps_test_tt_pt.mxf
Description	MXF track file containing timed text that matches the burned-in timecode at <i>2K 2D 96 FPS Test</i> .
Conforms to	SMPTE-377-1, SMPTE-429-3, SMPTE-429-5

A.2.291. 120 FPS test timecode

Type	MXF text
Filename	120_fps_test_tt_pt.mxf
Description	MXF track file containing timed text that matches the burned-in timecode at <i>2K 2D 120 FPS Test</i> .
Conforms to	SMPTE-377-1, SMPTE-429-3, SMPTE-429-5

A.2.292. SDR Dark Gray Scale

Type	MXF j2c
Filename	4k_full_sdr_dark_gray_j2c_pt.mxf
Description	MXF track file containing five seconds (120 frames) of a chart showing all gray step values in Table A.2 . This is followed by the step values, each as a full frame with a duration of 50 s.
Conforms to	SMPTE-377-1, SMPTE-422, SMPTE-429-3, SMPTE-429-4

Table A.2.292 Dark Gray Scale X'Y'Z' 12-bit Codevalues

Step Number	X'	Y'	Z'
1	269	274	283
2	270	275	284
3	271	276	285
4	272	277	286
5	273	278	287
6	274	279	288
7	275	280	289
8	276	281	290
9	277	282	292

10	278	283	292
11	279	284	293
12	279	285	295
13	280	286	296
14	281	287	297
15	282	288	298
16	283	289	299
17	284	290	300

A.2.293. HDR Dark Gray Scale

Type	MXF j2c
Filename	4k_full_hdr_dark_gray_j2c_pt.mxf
Description	HDR Picture Track File containing five seconds (120 frames) of a chart showing all gray step values in Table A.2 . This is followed by the step values, each as a full frame with a duration of 50 s.
Conforms to	SMPTE-377-1, SMPTE-422, SMPTE-429-3, SMPTE-429-4, [DCI-HDR]

Table A.2.293 Dark Gray Scale X"Y"Z" 12-bit Codevalues

Step Number	X"	Y"	Z"
1	177	181	188
2	178	182	189
3	179	183	190
4	180	184	191
5	181	185	192
6	182	186	193
7	183	187	194
8	184	188	195
9	185	189	196
10	186	190	197
11	187	191	198
12	188	192	199
13	189	193	200
14	190	194	201
15	191	195	203
16	192	196	204
17	193	197	205

A.3. Sound

A.3.1. Introduction

This section defines a set of MXF sound track files. For each track file, a description is given which details the sounds encoded in the file. The sound track files will be combined with image files to make complete compositions (see [Section A.4](#)).

A.3.2. Sync Count 5.1

Type	MXF pcm								
Filename	sync_count_51_pcm_pt.mxf								
Description	MXF track file containing six channels of audio. Channels 1,2,4,5 and 6 are silent. Channel 3 (Center) contains five seconds (120 frames) of silence followed by a ten second countdown and five seconds of silence. The countdown consists of ten identical one-second count segments. Each count segment consists of one frame (2000 samples) encoding of a 1 kHz sine wave at -20 dBFS, followed by 23 frames of silence.								
Conforms to	SMPTE-377-1, SMPTE-429-3, SMPTE-382								
Meta	<table> <tr> <td>SoundFormat</td> <td>5.1</td> </tr> <tr> <td>Duration</td> <td>00:20:00</td> </tr> <tr> <td>SampleRate</td> <td>48000</td> </tr> <tr> <td>EditRate</td> <td>24/1</td> </tr> </table>	SoundFormat	5.1	Duration	00:20:00	SampleRate	48000	EditRate	24/1
SoundFormat	5.1								
Duration	00:20:00								
SampleRate	48000								
EditRate	24/1								

A.3.3. Sync Count 5.1 (Encrypted)

Type	MXF pcm										
Filename	sync_count_51_pcm_ct.mxf										
Description	Encrypted MXF track file, contents are identical to Section A.3.2: Sync Count 5										
Conforms to	SMPTE-377-1, SMPTE-429-3, SMPTE-382, SMPTE-429-6										
Meta	<table> <tr> <td>SoundFormat</td> <td>5.1</td> </tr> <tr> <td>Encryption</td> <td>AES-128</td> </tr> <tr> <td>Duration</td> <td>00:20:00</td> </tr> <tr> <td>SampleRate</td> <td>48000</td> </tr> <tr> <td>EditRate</td> <td>24/1</td> </tr> </table>	SoundFormat	5.1	Encryption	AES-128	Duration	00:20:00	SampleRate	48000	EditRate	24/1
SoundFormat	5.1										
Encryption	AES-128										
Duration	00:20:00										
SampleRate	48000										
EditRate	24/1										

A.3.4. Sync Count 5.1 48fps

Type	MXF pcm
Filename	sync_count_51_48fps_pcm_pt.mxf
Description	MXF track file containing six channels of audio. Channels 1,2,4,5 and 6 are silent. Channel 3 (Center) contains five seconds (240 frames) of silence followed by a ten second countdown and five seconds of

	silence. The countdown consists of ten identical one-second count segments. Each count segment consists of two frames (2000 samples) encoding of a 1 kHz sine wave at -20 dBFS, followed by 46 frames of silence.								
Conforms to	SMPTE-377-1, SMPTE-429-3, SMPTE-382								
Meta	<table border="0"> <tr> <td>SoundFormat</td> <td>5.1</td> </tr> <tr> <td>Duration</td> <td>00:20:00</td> </tr> <tr> <td>SampleRate</td> <td>48000</td> </tr> <tr> <td>EditRate</td> <td>48/1</td> </tr> </table>	SoundFormat	5.1	Duration	00:20:00	SampleRate	48000	EditRate	48/1
SoundFormat	5.1								
Duration	00:20:00								
SampleRate	48000								
EditRate	48/1								

A.3.5. Channel I.D. 5.1

Type	MXF pcm								
Filename	channel_id_51_pcm_pt.mxf								
Description	MXF track file containing a repeated voice announcement of the channel label of the respective channel: Left (Channel 1), Center (Channel 3), Right (Channel 2), Left Surround (Channel 5), Right Surround (Channel 6), LFE (Channel 4). Voice announcements are sequential, in the order given here.								
Conforms to	SMPTE-377-1, SMPTE-429-3, SMPTE-382								
Malformations									
Meta	<table border="0"> <tr> <td>SoundFormat</td> <td>5.1</td> </tr> <tr> <td>Duration</td> <td>00:40:00</td> </tr> <tr> <td>SampleRate</td> <td>48000</td> </tr> <tr> <td>EditRate</td> <td>24/1</td> </tr> </table>	SoundFormat	5.1	Duration	00:40:00	SampleRate	48000	EditRate	24/1
SoundFormat	5.1								
Duration	00:40:00								
SampleRate	48000								
EditRate	24/1								

A.3.6. Channel I.D. 1-16

Type	MXF pcm
Filename	channel_id_01-16_pcm_pt.mxf
Description	MXF track file containing a sequential voice announcement of the channel number of the respective channel.
Conforms to	SMPTE-377-1, SMPTE-429-3, SMPTE-382

Meta	SoundFormat	WTF
	Duration	01:24:00
	SampleRate	48000
	EditRate	24/1

A.3.7. Pink Noise, 16 Channels

Type	MXF pcm	
Filename	pink_noise_1-16_pcm_pt.mxf	
Description	Pink (1/ f) noise at -20 dBFS on sixteen channels, band limited to 22 KHz. Identical, sample-aligned signal must be used on all channels.	
Conforms to	SMPTE-377-1, SMPTE-429-3, SMPTE-382	
Meta	SoundFormat	WTF
	Duration	00:30:00
	SampleRate	48000
	EditRate	24/1

A.3.8. Pink Noise, 16 Channels, 96 kHz

Type	MXF pcm	
Filename	pink_noise_1-16_96khz_pcm_pt.mxf	
Description	Pink (1/ f) noise at -20 dBFS on sixteen channels, band limited to 44 KHz. Identical, sample-aligned signal must be used on all channels.	
Conforms to	SMPTE-377-1, SMPTE-429-3, SMPTE-382	
Meta	SoundFormat	WTF
	Duration	00:30:00
	SampleRate	96000
	EditRate	24/1

A.3.9. Deleted Section

The section "Pink Noise, 16 Channels, 96 kHz (Encrypted)" was deleted. The section number is maintained here to preserve the numbering of subsequent sections.

A.3.10. Maximum Bitrate, 16 Channels, 96 kHz (Encrypted)

Type	MXF pcm										
Filename	max_bitrate_1-16_96khz_pcm_ct.mxf										
Description	Encrypted MXF sound track file containing a count to check synchronization between picture and sound, 10 minutes of pink (1/ f) noise at -20 dBFS on all sixteen channels, band limited to 44 KHz and a second sync count.										
Conforms to	SMPTE-377-1, SMPTE-429-3, SMPTE-382										
Meta	<table border="0"> <tr> <td>SoundFormat</td> <td>WTF</td> </tr> <tr> <td>Encryption</td> <td>AES-128</td> </tr> <tr> <td>Duration</td> <td>00:10:40:00</td> </tr> <tr> <td>SampleRate</td> <td>96000</td> </tr> <tr> <td>EditRate</td> <td>24/1</td> </tr> </table>	SoundFormat	WTF	Encryption	AES-128	Duration	00:10:40:00	SampleRate	96000	EditRate	24/1
SoundFormat	WTF										
Encryption	AES-128										
Duration	00:10:40:00										
SampleRate	96000										
EditRate	24/1										

A.3.11. 1 kHz Sine Wave

Type	MXF pcm								
Filename	1_khz_sine_wave_pcm_pt.mxf								
Description	MXF track file containing 1 kHz sine wave on sixteen channels at -20 dBFS.								
Conforms to	SMPTE-377-1, SMPTE-429-3, SMPTE-382								
Meta	<table border="0"> <tr> <td>SoundFormat</td> <td>WTF</td> </tr> <tr> <td>Duration</td> <td>02:00:00</td> </tr> <tr> <td>SampleRate</td> <td>48000</td> </tr> <tr> <td>EditRate</td> <td>24/1</td> </tr> </table>	SoundFormat	WTF	Duration	02:00:00	SampleRate	48000	EditRate	24/1
SoundFormat	WTF								
Duration	02:00:00								
SampleRate	48000								
EditRate	24/1								

A.3.12. 1 kHz Sine Wave, 16 Channels 96kHz

Type	MXF pcm						
Filename	1_khz_sine_wave_96khz_pcm_pt.mxf						
Description	MXF track file containing 96kHz sample rate 1 kHz sine wave on sixteen channels at -20 dBFS.						
Conforms to	SMPTE-377-1, SMPTE-429-3, SMPTE-382						
Meta	<table border="0"> <tr> <td>SoundFormat</td> <td>WTF</td> </tr> <tr> <td>Duration</td> <td>02:00:00</td> </tr> <tr> <td>SampleRate</td> <td>96000</td> </tr> </table>	SoundFormat	WTF	Duration	02:00:00	SampleRate	96000
SoundFormat	WTF						
Duration	02:00:00						
SampleRate	96000						

EditRate	24/1
-----------------	------

A.3.13. 400 hz sine wave

Type	MXF pcm								
Filename	400_hz_sine_wave_pcm_pt.mxf								
Description	MXF track file containing 400 Hz sine wave on six channels at -20 dBfs (dB Full Scale). LFE channel is full-range.								
Conforms to	SMPTE-377-1, SMPTE-429-3, SMPTE-382								
Meta	<table border="0"> <tr> <td>SoundFormat</td> <td>5.1</td> </tr> <tr> <td>Duration</td> <td>02:00:00</td> </tr> <tr> <td>SampleRate</td> <td>48000</td> </tr> <tr> <td>EditRate</td> <td>24/1</td> </tr> </table>	SoundFormat	5.1	Duration	02:00:00	SampleRate	48000	EditRate	24/1
SoundFormat	5.1								
Duration	02:00:00								
SampleRate	48000								
EditRate	24/1								

A.3.14. Deleted Section

The section "400 hz sine wave (Encrypted)" was deleted. The section number is maintained here to preserve the numbering of subsequent sections.

A.3.15. 400 hz sine wave, WTF (Encrypted)

Type	MXF pcm										
Filename	400_hz_sine_wave_wtf_pcm_ct.mxf										
Description	Encrypted MXF track file containing 400 Hz sine wave on sixteen channels at -20 dBfs (dB Full Scale). LFE channel is full-range.										
Conforms to	SMPTE-377-1, SMPTE-429-3, SMPTE-382										
Meta	<table border="0"> <tr> <td>SoundFormat</td> <td>WTF</td> </tr> <tr> <td>Encryption</td> <td>AES-128</td> </tr> <tr> <td>Duration</td> <td>02:00:00</td> </tr> <tr> <td>SampleRate</td> <td>48000</td> </tr> <tr> <td>EditRate</td> <td>24/1</td> </tr> </table>	SoundFormat	WTF	Encryption	AES-128	Duration	02:00:00	SampleRate	48000	EditRate	24/1
SoundFormat	WTF										
Encryption	AES-128										
Duration	02:00:00										
SampleRate	48000										
EditRate	24/1										

A.3.16. Silence, 5.1

Type	MXF pcm
Filename	black_51_pcm_pt.mxf

Description	MXF track file containing six channels of silence.	
Conforms to	SMPTE-377-1, SMPTE-429-3, SMPTE-382	
Meta	SoundFormat	5.1
	Duration	02:00:00
	SampleRate	48000
	EditRate	24/1

A.3.17. Silence, 5.1, 15 minutes

Type	MXF pcm	
Filename	black_long_51_pcm_pt.mxf	
Description	MXF track file containing six channels of silence.	
Conforms to	SMPTE-377-1, SMPTE-429-3, SMPTE-382	
Meta	SoundFormat	5.1
	Duration	00:15:00:00
	SampleRate	48000
	EditRate	24/1

A.3.18. Silence, 5.1, 15 minutes (Encrypted)

Type	MXF pcm	
Filename	black_long_51_pcm_ct.mxf	
Description	MXF track file containing six channels of silence.	
Conforms to	SMPTE-377-1, SMPTE-429-3, SMPTE-382, SMPTE-429-6	
Prerequisites	<i>Silence, 5.1, 15 minutes</i>	
Meta	SoundFormat	5.1
	Encryption	AES-128
	Duration	00:15:00:00
	SampleRate	48000
	EditRate	24/1

A.3.19. StEM 5.1 Sound

Type	MXF pcm								
Filename	StEM_51_pcm_pt.mxf								
Description	MXF track file containing 5.1 sound essence for the DCI StEM Mini Movie.								
Conforms to	SMPTE-377-1, SMPTE-429-3, SMPTE-382								
Meta	<table> <tr> <td>SoundFormat</td> <td>5.1</td> </tr> <tr> <td>Duration</td> <td>11:31:21</td> </tr> <tr> <td>SampleRate</td> <td>48000</td> </tr> <tr> <td>EditRate</td> <td>24/1</td> </tr> </table>	SoundFormat	5.1	Duration	11:31:21	SampleRate	48000	EditRate	24/1
SoundFormat	5.1								
Duration	11:31:21								
SampleRate	48000								
EditRate	24/1								

A.3.20. StEM 5.1 Sound (Encrypted)

Type	MXF pcm										
Filename	StEM_51_pcm_ct.mxf										
Description	Encrypted MXF track file containing 5.1 sound essence for the DCI StEM Mini Movie.										
Conforms to	SMPTE-377-1, SMPTE-429-3, SMPTE-429-6, SMPTE-382, SMPTE-429-4										
Meta	<table> <tr> <td>SoundFormat</td> <td>5.1</td> </tr> <tr> <td>Encryption</td> <td>AES-128</td> </tr> <tr> <td>Duration</td> <td>11:31:21</td> </tr> <tr> <td>SampleRate</td> <td>48000</td> </tr> <tr> <td>EditRate</td> <td>24/1</td> </tr> </table>	SoundFormat	5.1	Encryption	AES-128	Duration	11:31:21	SampleRate	48000	EditRate	24/1
SoundFormat	5.1										
Encryption	AES-128										
Duration	11:31:21										
SampleRate	48000										
EditRate	24/1										

A.3.21. StEM 5.1 Sound Multi-Reel A (Encrypted)

Type	MXF pcm multi								
Filename	StEM_51_pcm_multi_A_ct_<segment>.mxf								
Description	A set of encrypted MXF track files containing 5.1 sound essence for the DCI StEM Mini Movie.								
Conforms to	SMPTE-377-1, SMPTE-429-3, SMPTE-429-6, SMPTE-382, SMPTE-429-4								
Meta	<table> <tr> <td>SoundFormat</td> <td>5.1</td> </tr> <tr> <td>SegmentCount</td> <td>128</td> </tr> <tr> <td>Encryption</td> <td>AES-128</td> </tr> <tr> <td>SegmentDuration</td> <td>00:05:00</td> </tr> </table>	SoundFormat	5.1	SegmentCount	128	Encryption	AES-128	SegmentDuration	00:05:00
SoundFormat	5.1								
SegmentCount	128								
Encryption	AES-128								
SegmentDuration	00:05:00								

Duration	00:10:40:00
SampleRate	48000
EditRate	24/1

A.3.22. StEM 5.1 Sound Multi-Reel B (Encrypted)

Type	MXF pcm multi														
Filename	StEM_51_pcm_multi_B_ct_<segment>.mxf														
Description	A set of encrypted MXF track files containing 5.1 sound essence for the DCI StEM Mini Movie. Identical to StEM_51_pcm_multi_A_ct														
Conforms to	SMPTE-377-1, SMPTE-429-3, SMPTE-429-6, SMPTE-382, SMPTE-429-4														
Meta	<table border="0"> <tr> <td>SoundFormat</td> <td>5.1</td> </tr> <tr> <td>SegmentCount</td> <td>128</td> </tr> <tr> <td>Encryption</td> <td>AES-128</td> </tr> <tr> <td>SegmentDuration</td> <td>00:05:00</td> </tr> <tr> <td>Duration</td> <td>00:10:40:00</td> </tr> <tr> <td>SampleRate</td> <td>48000</td> </tr> <tr> <td>EditRate</td> <td>24/1</td> </tr> </table>	SoundFormat	5.1	SegmentCount	128	Encryption	AES-128	SegmentDuration	00:05:00	Duration	00:10:40:00	SampleRate	48000	EditRate	24/1
SoundFormat	5.1														
SegmentCount	128														
Encryption	AES-128														
SegmentDuration	00:05:00														
Duration	00:10:40:00														
SampleRate	48000														
EditRate	24/1														

A.3.23. StEM 5.1 Sound Multi-Reel A

Type	MXF pcm multi												
Filename	StEM_51_pcm_multi_A_pt_<segment>.mxf												
Description	A set of plaintext MXF track files containing 5.1 sound essence for the DCI StEM Mini Movie. 128 files, each with a duration of 5 seconds.												
Conforms to	SMPTE-377-1, SMPTE-429-3, SMPTE-429-6, SMPTE-382, SMPTE-429-4												
Meta	<table border="0"> <tr> <td>SoundFormat</td> <td>5.1</td> </tr> <tr> <td>SegmentCount</td> <td>128</td> </tr> <tr> <td>SegmentDuration</td> <td>00:05:00</td> </tr> <tr> <td>Duration</td> <td>00:10:40:00</td> </tr> <tr> <td>SampleRate</td> <td>48000</td> </tr> <tr> <td>EditRate</td> <td>24/1</td> </tr> </table>	SoundFormat	5.1	SegmentCount	128	SegmentDuration	00:05:00	Duration	00:10:40:00	SampleRate	48000	EditRate	24/1
SoundFormat	5.1												
SegmentCount	128												
SegmentDuration	00:05:00												
Duration	00:10:40:00												
SampleRate	48000												
EditRate	24/1												

A.3.24. StEM 5.1 Sound Multi-Reel B

Type	MXF pcm multi
Filename	StEM_51_pcm_multi_B_pt_<segment>.mxf
Description	A set of plaintext MXF track files containing 5.1 sound essence for the DCI StEM Mini Movie. Identical to StEM_51_pcm_multi_A_pt
Conforms to	SMPTE-377-1, SMPTE-429-3, SMPTE-429-6, SMPTE-382, SMPTE-429-4
Meta	SoundFormat 5.1 SegmentCount 128 SegmentDuration 00:05:00 Duration 00:10:40:00 SampleRate 48000 EditRate 24/1

A.3.25. StEM 48fps 5.1 Sound

Type	MXF pcm
Filename	StEM_48fps_51_pcm_pt.mxf
Description	MXF track file containing 5.1 sound essence for the 48 fps DCI StEM Mini Movie.
Conforms to	SMPTE-377-1, SMPTE-429-3, SMPTE-382
Meta	SoundFormat 5.1 Duration 00:51:46 SampleRate 48000 EditRate 48/1

A.3.26. Deleted Section

The section "FM StEM 5.1 Sound (Encrypted)" was deleted. The section number is maintained here to preserve the numbering of subsequent sections.

A.3.27. FM StEM WTF Sound

Type	MXF pcm
Filename	fm_StEM_wtf_pcm_pt.mxf
Description	MXF track file for FM testing containing WTF sound essence for the DCI StEM Mini Movie.

Conforms to	SMPTE-377-1, SMPTE-429-3, SMPTE-382	
Meta	SoundFormat	WTF
	Duration	11:31:21
	SampleRate	48000
	EditRate	24/1

A.3.28. FM StEM WTF Sound (Encrypted)

Type	MXF pcm	
Filename	fm_StEM_wtf_pcm_ct.mxf	
Description	Encrypted MXF track file for FM testing containing WTF sound essence for the DCI StEM Mini Movie.	
Conforms to	SMPTE-377-1, SMPTE-429-3, SMPTE-429-6, SMPTE-382, SMPTE-429-4	
Meta	SoundFormat	WTF
	Encryption	AES-128
	Duration	11:31:21
	SampleRate	48000
	EditRate	24/1

A.3.29. Binary Audio FM Bypass WTF Sound (Encrypted)

Type	MXF pcm	
Filename	binary_audio_fm_bypass_wtf_pcm_ct.mxf	
Description	Encrypted MXF track file for FM testing containing known binary audio content on 16 channels of WTF format sound essence.	
Conforms to	SMPTE-377-1, SMPTE-429-3, SMPTE-429-6, SMPTE-382, SMPTE-429-4	
Meta	SoundFormat	WTF
	Encryption	AES-128
	Duration	10:00:00
	SampleRate	48000
	EditRate	24/1

A.3.30. m02 Sound Frame Out Of Order (Encrypted)

Type	MXF pcm	
Filename	m02_snd_frame_oo_51_pcm_ct.mxf	
Description	Malformed, encrypted MXF track file containing six channels of 400Hz sine waves.	
Conforms to	SMPTE-377-1, SMPTE-429-3, SMPTE-382, SMPTE-429-4	
Malformations	The KLV packets containing edit units 01 and 02 are swapped.	
Meta	SoundFormat	5.1
	Encryption	AES-128
	Duration	00:00:05:00
	SampleRate	48000
	EditRate	24/1

A.3.31. m04 Sound Track File With Wrong TrackFile ID (Encrypted)

Type	MXF pcm	
Filename	m04_sndtk_wrong_file_pcm_ct.mxf	
Description	MXF track file in which the integrity pack of the 7th frame has the TrackFile ID replaced with a different value.	
Conforms to	SMPTE-377-1, SMPTE-422, SMPTE-429-3, SMPTE-429-4	
Meta	Encryption	AES-128
	Duration	00:00:05:00
	EditRate	24/1

A.3.32. m10 Sound track file with bad HMAC (Encrypted)

Type	MXF pcm	
Filename	m10_snd_bad_hmac_pcm_ct.mxf	
Description	Sound track file in which one of the HMAC values for a single frame has been changed.	
Conforms to	SMPTE-377-1, SMPTE-429-3, SMPTE-382	
Malformations	The file contains a replacement EKLK packet for the seventh frame (index 6). The replacement packet is taken from another track file having a different PackageUID but encrypted with the same symmetric key.	
Meta	SoundFormat	5.1
	Encryption	AES-128

Duration	00:00:05:00
SampleRate	48000
EditRate	24/1

A.3.33. m12 Sound Track File With Bad Check Value (Encrypted)

Type	MXF pcm						
Filename	m12_snd_bad_chuk_pcm_ct.mxf						
Description	MXF track file containing one EKLv packet with an invalid Check Value.						
Conforms to	SMPTE-377-1, SMPTE-422, SMPTE-429-3, SMPTE-429-4						
Meta	<table border="0"> <tr> <td>Encryption</td> <td>AES-128</td> </tr> <tr> <td>Duration</td> <td>00:00:05:00</td> </tr> <tr> <td>EditRate</td> <td>24/1</td> </tr> </table>	Encryption	AES-128	Duration	00:00:05:00	EditRate	24/1
Encryption	AES-128						
Duration	00:00:05:00						
EditRate	24/1						

A.3.34. 400 hz sine wave, WTF

Type	MXF pcm								
Filename	400_hz_sine_wave_wtf_pcm_pt.mxf								
Description	MXF track file containing 400 Hz sine wave on sixteen channels at -20 dBfs (dB Full Scale). LFE channel is full-range.								
Conforms to	SMPTE-377-1, SMPTE-429-3, SMPTE-382								
Meta	<table border="0"> <tr> <td>SoundFormat</td> <td>WTF</td> </tr> <tr> <td>Duration</td> <td>02:00:00</td> </tr> <tr> <td>SampleRate</td> <td>48000</td> </tr> <tr> <td>EditRate</td> <td>24/1</td> </tr> </table>	SoundFormat	WTF	Duration	02:00:00	SampleRate	48000	EditRate	24/1
SoundFormat	WTF								
Duration	02:00:00								
SampleRate	48000								
EditRate	24/1								

A.3.35. Silence, 5.1 (Encrypted)

Type	MXF pcm
Filename	black_51_pcm_ct.mxf
Description	Encrypted MXF track file containing six channels of silence.
Conforms to	SMPTE-377-1, SMPTE-429-3, SMPTE-382, SMPTE-429-6
Prerequisites	<i>Silence, 5.1</i>

Meta	SoundFormat	5.1
	Encryption	AES-128
	Duration	02:00:00
	SampleRate	48000
	EditRate	24/1

A.3.36. Silence, 5.1, 48 fps (Encrypted)

Type	MXF pcm	
Filename	black_51_48fps_pcm_ct.mxf	
Description	48 Frames per second (fps) MXF track file containing six channels of silence.	
Conforms to	SMPTE-377-1, SMPTE-429-3, SMPTE-382, SMPTE-429-6	
Meta	SoundFormat	5.1
	Encryption	AES-128
	Duration	00:02:00:00
	SampleRate	48000
	EditRate	48/1

A.3.37. StEM 5.1 Sound Multi-Reel C (Encrypted)

Type	MXF pcm multi	
Filename	StEM_51_pcm_multi_C_ct_<segment>.mxf	
Description	A set of encrypted MXF track files containing 5.1 sound essence for the DCI StEM Mini Movie. 64 files, each with a duration of 1 second.	
Conforms to	SMPTE-377-1, SMPTE-429-3, SMPTE-429-6, SMPTE-382, SMPTE-429-4	
Meta	SoundFormat	5.1
	SegmentCount	64
	Encryption	AES-128
	SegmentDuration	00:01:00
	Duration	00:01:04:00
	SampleRate	48000
	EditRate	24/1

A.3.38. Sync Count OBAE (Encrypted)

Type	MXF obae
Filename	sync_count_obae_ct.mxf
Description	Encrypted version of Section A.3.39: Sync Count OBAE
Conforms to	SMPTE-377-1, SMPTE-429-3, SMPTE-429-18, SMPTE-429-6

A.3.39. Sync Count OBAE

Type	MXF obae
Filename	sync_count_obae_pt.mxf
Description	Immersive Audio track file where the center channel of the 9.1OH bed contains five seconds (120 frames) of silence followed by a ten second countdown and five seconds of silence. The countdown consists of ten identical one-second count segments. Each count segment consists of one frame (2000 samples) encoding of a 1 kHz sine wave at -20 dBFS, followed by 23 frames of silence.
Conforms to	SMPTE-377-1, SMPTE-429-3, SMPTE-429-18

A.3.40. Main Sound for Sync Count OBAE (Encrypted)

Type	MXF pcm
Filename	sync_count_obae_ms_ct.mxf
Description	Encrypted version of Section A.3.41: Main Sound for Sync Count OBAE .
Conforms to	SMPTE-377-1, SMPTE-429-3, SMPTE-382, SMPTE-429-6, SMPTE-430-12, SMPTE-429-19

A.3.41. Main Sound for Sync Count OBAE

Type	MXF pcm
Filename	sync_count_obae_ms_pt.mxf
Description	Sound Track File as specified in SMPTE ST 429-19, where the FSK synchronization signal is intended to synchronize playback of Section A.3.39: Sync Count OBAE .
Conforms to	SMPTE-377-1, SMPTE-429-3, SMPTE-382, SMPTE-430-12, SMPTE-429-19

A.3.42. Main Sound for StEM OBAE (Encrypted)

Type	MXF pcm
Filename	StEM_obae_ms_ct.mxf
Description	Encrypted version of Section A.3.43: Main Sound for StEM OBAE .
Conforms to	SMPTE-377-1, SMPTE-429-3, SMPTE-382, SMPTE-429-6, SMPTE-430-12, SMPTE-429-19

A.3.43. Main Sound for StEM OBAE

Type	MXF pcm
Filename	StEM_obae_ms_pt.mxf
Description	Sound Track File as specified in SMPTE ST 429-19, where the FSK synchronization signal is intended to synchronize playback of Section A.3.45: StEM OBAE .
Conforms to	SMPTE-377-1, SMPTE-429-3, SMPTE-382, SMPTE-430-12, SMPTE-429-19

A.3.44. StEM OBAE (Encrypted)

Type	MXF obae
Filename	StEM_obae_ct.mxf
Description	Encrypted version of Section A.3.45: StEM OBAE
Conforms to	SMPTE-377-1, SMPTE-429-3, SMPTE-429-18, SMPTE-429-6

A.3.45. StEM OBAE

Type	MXF obae
Filename	StEM_obae_pt.mxf
Description	Immersive Audio track file for the StEM mini-movie.
Conforms to	SMPTE-377-1, SMPTE-429-3, SMPTE-429-18

A.3.46. M28 Sound Track File with Malformed Integrity Pack: Missing MIC item (Encrypted)

Type	MXF pcm
Filename	m28_integrity_snd_mic_pcm_ct.mxf
Description	Encrypted MXF track file, contents are identical to <i>Sync Count 5.1</i> but the 1,441th edit unit is missing the MIC item.
Conforms to	SMPTE-377-1, SMPTE-429-3, SMPTE-382, SMPTE-429-6
Malformations	The 1,441th edit unit is missing the MIC item

A.3.47. M30 Sound Track File with Malformed Integrity Pack: Missing TrackFileID item (Encrypted)

Type	MXF pcm
Filename	m30_integrity_snd_tfid_pcm_ct.mxf
Description	Encrypted MXF track file, contents are identical to <i>Sync Count 5.1</i> but the 1,441th edit unit is missing the TrackFileID item.

Conforms to	SMPTE-377-1, SMPTE-429-3, SMPTE-382, SMPTE-429-6
Malformations	The 1,441th edit unit is missing the TrackFileID item

A.3.48. M29 Sound Track File with Malformed Integrity Pack: Missing SequenceNumber item (Encrypted)

Type	MXF pcm
Filename	m29_integrity_snd_snum_pcm_ct.mxf
Description	Encrypted MXF track file, contents are identical to <i>Sync Count 5.1</i> but the 1,441th edit unit is missing the SequenceNumber item.
Conforms to	SMPTE-377-1, SMPTE-429-3, SMPTE-382, SMPTE-429-6
Malformations	The 1,441th edit unit is missing the SequenceNumber item

A.3.49. M20 Sound Track File with Malformed Integrity Pack: Missing MIC item (OBAE) (Encrypted)

Type	MXF pcm
Filename	m20_integrity_obae_ms_mic_pcm_ct.mxf
Description	Encrypted MXF track file, contents are identical to <i>Main Sound for Sync Count OBAE</i> but the 1,441th edit unit is missing the MIC item.
Conforms to	SMPTE-377-1, SMPTE-429-3, SMPTE-382, SMPTE-429-6, SMPTE-430-12, SMPTE-429-19
Malformations	The 1,441th edit unit is missing the MIC item

A.3.50. M22 Sound Track File with Malformed Integrity Pack: Missing TrackFileID item (OBAE) (Encrypted)

Type	MXF pcm
Filename	m22_integrity_obae_ms_tfid_pcm_ct.mxf
Description	Encrypted MXF track file, contents are identical to <i>Main Sound for Sync Count OBAE</i> but the 1,441th edit unit is missing the TrackFileID item.
Conforms to	SMPTE-377-1, SMPTE-429-3, SMPTE-382, SMPTE-429-6, SMPTE-430-12, SMPTE-429-19
Malformations	The 1,441th edit unit is missing the TrackFileID item

A.3.51. M21 Sound Track File with Malformed Integrity Pack: Missing SequenceNumber item (OBAE) (Encrypted)

Type	MXF pcm
Filename	m21_integrity_obae_ms_snum_pcm_ct.mxf

Description	Encrypted MXF track file, contents are identical to <i>Main Sound for Sync Count OBAE</i> but the 1,441th edit unit is missing the SequenceNumber item.
Conforms to	SMPTE-377-1, SMPTE-429-3, SMPTE-382, SMPTE-429-6, SMPTE-430-12, SMPTE-429-19
Malformations	The 1,441th edit unit is missing the SequenceNumber item

A.3.52. M19 OBAE Track File with Malformed Integrity Pack: Missing MIC item (Encrypted)

Type	MXF obae
Filename	m19_integrity_obae_mic_obae_ct.mxf
Description	Encrypted MXF track file, contents are identical to <i>Sync Count OBAE</i> but the 1,441th edit unit is missing the MIC item.
Conforms to	SMPTE-377-1, SMPTE-429-3, SMPTE-492-18, SMPTE-429-6
Malformations	The 1,441th edit unit is missing the MIC item

A.3.53. M24 OBAE Track File with Malformed Integrity Pack: Missing TrackFileID item (OBAE) (Encrypted)

Type	MXF obae
Filename	m24_integrity_obae_tfid_obae_ct.mxf
Description	Encrypted MXF track file, contents are identical to <i>Sync Count OBAE</i> but the 1,441th edit unit is missing the TrackFileID item.
Conforms to	SMPTE-377-1, SMPTE-429-3, SMPTE-492-18, SMPTE-429-6
Malformations	The 1,441th edit unit is missing the TrackFileID item

A.3.54. M23 OBAE Track File with Malformed Integrity Pack: Missing SequenceNumber item (Encrypted)

Type	MXF obae
Filename	m23_integrity_obae_snum_obae_ct.mxf
Description	Encrypted MXF track file, contents are identical to <i>Sync Count OBAE</i> but the 1,441th edit unit is missing the SequenceNumber item.
Conforms to	SMPTE-377-1, SMPTE-429-3, SMPTE-492-18, SMPTE-429-6
Malformations	The 1,441th edit unit is missing the SequenceNumber item

A.3.55. StEM OBAE Multi-Reel C (Encrypted)

Type	MXF obae multi
Filename	StEM_obae_multi_C_ct_<segment>.mxf

Description	A set of encrypted track files containing OBAE essence for the DCI StEM Mini Movie. 64 files, each with a duration of 1 second.
Conforms to	SMPTE-377-1, SMPTE-429-3, SMPTE-429-6, SMPTE-429-18

A.3.56. Main Sound for StEM OBAE Multi-Reel C (Encrypted)

Type	MXF pcm multi
Filename	StEM_obae_ms_multi_C_ct_<segment>.mxf
Description	A set of encrypted sound track files, where the FSK synchronization signal is intended to synchronize playback of Section A.3.55: StEM OBAE Multi-Reel C (Encrypted) . 64 files, each with a duration of 1 second.
Conforms to	SMPTE-377-1, SMPTE-429-3, SMPTE-429-6, SMPTE-382, SMPTE-430-12, SMPTE-429-19

A.3.57. M40 OBAE Track File with Frame-out-of-order error (Encrypted)

Type	MXF obae
Filename	m40_obae_frame_oo_ct.mxf
Description	Encrypted MXF track file, contents are identical to <i>Sync Count OBAE</i> but the KLV packets for the 1st and 2nd edit units are swapped.
Conforms to	SMPTE-377-1, SMPTE-429-3, SMPTE-492-18, SMPTE-429-6
Malformations	The 1st and 2nd edit units contain out-of-order Sequence Number item values.

A.3.58. M41 OBAE Track File With Wrong TrackFile ID (Encrypted)

Type	MXF obae
Filename	m41_obae_wrong_file_ct.mxf
Description	Encrypted MXF track file, contents are identical to <i>Sync Count OBAE</i> but with the TrackFile ID item value of the 7th edit unit replaced with a different value.
Conforms to	SMPTE-377-1, SMPTE-429-3, SMPTE-492-18, SMPTE-429-6
Malformations	The TrackFile ID item value of the 7th edit unit is not equal to the identifier of the Track File.

A.3.59. Sync Count OBAE with MIC Key (Encrypted)

Type	MXF obae mkey
Filename	sync_count_obae_mkey_ct.mxf
Description	Encrypted MXF track file, contents are identical to <i>Sync Count OBAE</i> , with the MIC item value computed using the MIC Key c5 9a f6 6f bd e0 70 39 ba 36 2c 62 e8 21 e6 02.
Conforms to	SMPTE-377-1, SMPTE-429-3, SMPTE-492-18, SMPTE-429-6, DCI-DCSS

A.3.60. M43 OBAE Track File With Bad Check Value (Encrypted)

Type	MXF obae
Filename	m43_obae_bad_chuk_ct.mxf
Description	Encrypted MXF track file, contents are identical to <i>Sync Count OBAE</i> but with the Check Value of the 7th edit unit replaced with an invalid value.
Conforms to	SMPTE-377-1, SMPTE-429-3, SMPTE-492-18, SMPTE-429-6
Malformations	The Check Value value of the 7th edit unit is invalid.

A.3.61. Deleted Section

The section "Sync Count 5.1 with KDM-Borne MIC Key" was deleted. The section number is maintained here to preserve the numbering of subsequent sections.

A.3.62. Sync Count 5.1 with KDM-Borne MIC Key (Encrypted)

Type	MXF pcm
Filename	sync_count_51_pcm_mkey_ct.mxf
Description	Encrypted MXF track file, contents are identical to <u>A.3.2. Sync Count 5.1</u> but with KDM-borne MIC Keys.
Conforms to	SMPTE-377-1, SMPTE-429-3, SMPTE-382, SMPTE-429-6

A.3.63. M44 OBAE Track File With Bad HMAC Value (Encrypted)

Type	MXF obae
Filename	m44_obae_bad_hmac_ct.mxf
Description	Encrypted MXF track file, contents are identical to <i>Sync Count OBAE</i> but with the HMAC value of the 7th edit unit replaced with an invalid value.
Conforms to	SMPTE-377-1, SMPTE-429-3, SMPTE-492-18, SMPTE-429-6
Malformations	The HMAC value of the 7th edit unit is invalid.

A.3.64. OBAE Tone Multi-Reel (Encrypted)

Type	MXF obae multi
Filename	OBAE_tone_multi_ct_<segment>.mxf
Description	Sequence of 20 Encrypted OBAE Track Files, each 1 second long, whose IA Frame contents, when concatenated, form a single continuous IA Bitstream. The IA Bitstream consists of (a) 9.1OH bed channels, each containing a 400 Hz sine wave tone (-20 dBFS), and (b) one stationary object, using a 400 Hz sine wave tone (-20 dBFS).
Conforms to	SMPTE-377-1, SMPTE-429-3, SMPTE-429-18, SMPTE-429-6

A.3.65. Deleted Section

The section "OBAE Tone Multi-Reel" was deleted. The section number is maintained here to preserve the numbering of subsequent sections.

A.3.66. Main Sound for OBAE Tone Multi-Reel (Encrypted)

Type	MXF pcm multi
Filename	OBAE_tone_multi_ms_ct_<segment>.mxf
Description	Sequence of Encrypted Sound Track Files, each as specified in SMPTE ST 429-19, where the FSK synchronization signal is intended to synchronize playback of A.3.65. Deleted Section .
Conforms to	SMPTE-377-1, SMPTE-429-3, SMPTE-429-6, SMPTE-382, SMPTE-430-12, SMPTE-429-19

A.3.67. Deleted Section

The section "Main Sound for OBAE Tone Multi-Reel" was deleted. The section number is maintained here to preserve the numbering of subsequent sections.

A.3.68. Audio Tone Multi-Reel (Encrypted)

Type	MXF pcm multi
Filename	audio_tone_multi_ct_<segment>.mxf
Description	Sequence of 20 encrypted audio track files, each 1 second long, whose contents, when concatenated, consists of a continuous 400 Hz sine wave on sixteen channels at -20 dBfs (dB Full Scale). The LFE channel is full-range.
Conforms to	SMPTE-377-1, SMPTE-429-3, SMPTE-429-6, SMPTE-382

A.3.69. Deleted Section

The section "Audio Tone Multi-Reel" was deleted. The section number is maintained here to preserve the numbering of subsequent sections.

A.3.70. Main Sound for Sync Count (48fps) OBAE

Type	MXF pcm
Filename	sync_count_48fps_obae_ms_pt.mxf
Description	Sound Track File as specified in SMPTE ST 429-19, where the FSK synchronization signal is intended to synchronize playback of Sync Count (48fps) OBAE .
Conforms to	SMPTE-377-1, SMPTE-429-3, SMPTE-382, SMPTE-430-12, SMPTE-429-19

A.3.71. Sync Count (48fps) OBAE

Type	MXF obae
-------------	----------

Filename	sync_count_48fps_obae_pt.mxf
Description	Identical content to <u>Sync Count OBAE</u> , but framed at 48 fps.
Conforms to	SMPTE-377-1, SMPTE-429-3, SMPTE-429-18

A.3.72. 400 hz sine wave (OBAE)

Type	MXF obae
Filename	400_hz_sine_wave_obae_pt.mxf
Description	The IA Bitstream consists of (a) 9.1OH bed channels, each containing a 400 Hz sine wave tone (-20 dBFS), and (b) one stationary object located on the ceiling (z=1), using a 400 Hz sine wave tone (-20 dBFS).
Conforms to	SMPTE-377-1, SMPTE-429-3, SMPTE-429-18

A.3.73. 400 hz sine wave (OBAE) (Encrypted)

Type	MXF obae
Filename	400_hz_sine_wave_obae_ct.mxf
Description	Encrypted version of <u>A.3.72. 400 hz sine wave (OBAE)</u>
Conforms to	SMPTE-377-1, SMPTE-429-3, SMPTE-429-18, SMPTE-429-6

A.3.74. Main Sound for 400 hz sine wave (OBAE)

Type	MXF pcm
Filename	400_hz_sine_wave_obae_ms_pt.mxf
Description	Sound Track File as specified in SMPTE ST 429-19 that contains only an FSK synchronization signal intended to synchronize playback of <u>A.3.72. 400 hz sine wave (OBAE)</u> .
Conforms to	SMPTE-377-1, SMPTE-429-3, SMPTE-382, SMPTE-430-12, SMPTE-429-19

A.3.75. FM StEM OBAE

Type	MXF obae
Filename	fm_StEM_obae_pt.mxf
Description	Intended to accompany the DCI StEM Mini Movie for FM testing. The IA Bitstream consists of (a) 9.1OH bed channels, each containing a 400 Hz sine wave tone (-20 dBFS), and (b) one object, using a 400 Hz sine wave tone (-20 dBFS), whose trajectory uniformly covers the unit hemisphere.
Conforms to	SMPTE-377-1, SMPTE-429-3, SMPTE-429-18

A.3.76. FM StEM OBAE (Encrypted)

Type	MXF obae
Filename	fm_StEM_obae_ct.mxf
Description	Encrypted version of A.3.75. FM StEM OBAE
Conforms to	SMPTE-377-1, SMPTE-429-3, SMPTE-429-18, SMPTE-429-6

A.3.77. Main Sound for FM StEM OBAE

Type	MXF pcm
Filename	fm_StEM_obae_ms_pt.mxf
Description	Sound Track File as specified in SMPTE ST 429-19, that contains only an FSK synchronization signal intended to synchronize playback of A.3.75. FM StEM OBAE .
Conforms to	SMPTE-377-1, SMPTE-429-3, SMPTE-382, SMPTE-430-12, SMPTE-429-19

A.3.78. StEM OBAE Multi-Reel A

Type	MXF obae multi
Filename	StEM_obae_multi_A_pt_<segment>.mxf
Description	A set of plaintext Immersive Audio track files for the StEM mini-movie. 128 files, each with a duration of 5 seconds.
Conforms to	SMPTE-377-1, SMPTE-429-3, SMPTE-429-18

A.3.79. Main Sound for StEM OBAE Multi-Reel A

Type	MXF pcm multi
Filename	StEM_obae_ms_multi_A_pt_<segment>.mxf
Description	A set of plaintext Sound Track Files, each as specified in [SMPTE-429-19], where the FSK synchronization signal is intended to synchronize playback of Section A.3.45: StEM OBAE . 128 files, each with a duration of 5 seconds.
Conforms to	SMPTE-377-1, SMPTE-429-3, SMPTE-382, SMPTE-430-12, SMPTE-429-19

A.3.80. StEM OBAE Multi-Reel B

Type	MXF obae multi
Filename	StEM_obae_multi_B_pt_<segment>.mxf
Description	Set of Track Files whose essence and segmentation are identical to those at A.3.78. StEM OBAE Multi-Reel A .
Conforms to	SMPTE-377-1, SMPTE-429-3, SMPTE-429-18

A.3.81. Main Sound for StEM OBAE Multi-Reel B

Type	MXF pcm multi
Filename	StEM_obae_ms_multi_B_pt_<segment>.mxfl
Description	Set of Track Files whose essence and segmentation are identical to those at A.3.79. Main Sound for StEM OBAE Multi-Reel A .
Conforms to	SMPTE-377-1, SMPTE-429-3, SMPTE-382, SMPTE-430-12, SMPTE-429-19

A.3.82. StEM OBAE Multi-Reel A (Encrypted)

Type	MXF obae multi
Filename	StEM_obae_multi_A_ct_<segment>.mxfl
Description	Encrypted version of A.3.78. StEM OBAE Multi-Reel A , where the same cryptographic key is used for every 2 consecutive Track Files, resulting in 64 distinct cryptographic keys being used.
Conforms to	SMPTE-377-1, SMPTE-429-3, SMPTE-429-18, SMPTE-429-6

A.3.83. Main Sound for StEM OBAE Multi-Reel A (Encrypted)

Type	MXF pcm multi
Filename	StEM_obae_ms_multi_A_ct_<segment>.mxfl
Description	Encrypted version of A.3.79. Main Sound for StEM OBAE Multi-Reel A , where the same cryptographic key is used for every 2 consecutive Track Files, resulting in 64 distinct cryptographic keys being used.
Conforms to	SMPTE-377-1, SMPTE-429-3, SMPTE-382, SMPTE-429-6, SMPTE-430-12, SMPTE-429-19

A.3.84. StEM OBAE Multi-Reel B (Encrypted)

Type	MXF obae multi
Filename	StEM_obae_multi_B_ct_<segment>.mxfl
Description	Encrypted version of A.3.80. StEM OBAE Multi-Reel B , where the same cryptographic key is used for every 2 consecutive Track Files, resulting in 64 distinct cryptographic keys being used.
Conforms to	SMPTE-377-1, SMPTE-429-3, SMPTE-429-18, SMPTE-429-6

A.3.85. Main Sound for StEM OBAE Multi-Reel B (Encrypted)

Type	MXF pcm multi
Filename	StEM_obae_ms_multi_B_ct_<segment>.mxfl
Description	Encrypted version of A.3.81. Main Sound for StEM OBAE Multi-Reel B , where the same cryptographic key is used for every 2 consecutive Track Files, resulting in 64 distinct cryptographic keys being used.

Conforms to	SMPTE-377-1, SMPTE-429-3, SMPTE-382, SMPTE-429-6, SMPTE-430-12, SMPTE-429-19
--------------------	--

A.3.86. Maximum Bitrate OBAE 48 fps (Encrypted)

Type	MXF obae
Filename	maximum_bitrate_48Hz_obae_obae_ct.mxf
Description	Intended to accompany <i>StEM 2K 48 fps</i> . The IA Bitstream has a duration of 640s, has a frame rate of 48 Hz and each frame is the maximum size specified in [SMPTE-429-18].
Conforms to	SMPTE-377-1, SMPTE-429-3, SMPTE-429-18, SMPTE-429-6

A.3.87. Main Sound for Maximum Bitrate OBAE 48 fps (Encrypted)

Type	MXF pcm
Filename	maximum_bitrate_48Hz_obae_pcm_ct.mxf
Description	Sound Track File as specified in SMPTE ST 429-19, that contains only an FSK synchronization signal intended to synchronize playback of A.3.86. Maximum Bitrate OBAE 48 fps (Encrypted) .
Conforms to	SMPTE-377-1, SMPTE-429-3, SMPTE-382, SMPTE-429-6, SMPTE-430-12, SMPTE-429-19

A.3.88. Maximum Bitrate OBAE (Encrypted)

Type	MXF obae
Filename	maximum_bitrate_24Hz_obae_obae_ct.mxf
Description	Intended to accompany <i>StEM 2K</i> . The IA Bitstream has a duration of 640s, has a frame rate of 24 Hz and each frame is the maximum size specified in [SMPTE-429-18].
Conforms to	SMPTE-377-1, SMPTE-429-3, SMPTE-429-18, SMPTE-429-6

A.3.89. Main Sound for Maximum Bitrate OBAE (Encrypted)

Type	MXF pcm
Filename	maximum_bitrate_24Hz_obae_pcm_ct.mxf
Description	Sound Track File as specified in SMPTE ST 429-19, that contains only an FSK synchronization signal intended to synchronize playback of A.3.88. Maximum Bitrate OBAE (Encrypted) .
Conforms to	SMPTE-377-1, SMPTE-429-3, SMPTE-382, SMPTE-429-6, SMPTE-430-12, SMPTE-429-19

A.3.90. OBAE Rendering Test

Type	MXF obae
Filename	obae_render_test_j2c_pt.mxf
Description	Exercises selected OBAE bitstream capabilities.

Conforms to	SMPTE-377-1, SMPTE-429-3, SMPTE-429-18
--------------------	--

A.3.91. Main Sound for OBAE Rendering Test

Type	MXF pcm
Filename	obae_render_test_ms_pt.mxf
Description	Sound Track File as specified in SMPTE ST 429-19, that contains only an FSK synchronization signal intended to synchronize playback of A.3.90. OBAE Rendering Test.
Conforms to	SMPTE-377-1, SMPTE-429-3, SMPTE-382, SMPTE-430-12, SMPTE-429-19

A.3.92. Silence w/ HI/VI

Type	MXF pcm
Filename	obae_render_test_ms_silence_pt.mxf
Description	Sound Track File that contains silence on all channels but HI/VI.
Conforms to	SMPTE-377-1, SMPTE-429-3, SMPTE-382

A.3.93. Silence, OBAE, 15 minutes (Encrypted)

Type	MXF obae
Filename	black_long_obae_ct.mxf
Description	Encrypted Immersive Audio Track File that contains an IA Bitstream with a duration of 900s long and a frame rate of 24 Hz. The IA Bitstream contains no objects and has a single 9.1OH bed that contains silence.
Conforms to	SMPTE-377-1, SMPTE-429-3, SMPTE-429-18, SMPTE-429-6

A.3.94. Main Sound for Silence, OBAE, 15 minutes (Encrypted)

Type	MXF pcm
Filename	black_long_obae_ms_ct.mxf
Description	Encrypted Sound Track File as specified in SMPTE ST 429-19, that contains only an FSK synchronization signal intended to synchronize playback of A.3.93. Silence, OBAE, 15 minutes (Encrypted).
Conforms to	SMPTE-377-1, SMPTE-429-3, SMPTE-382, SMPTE-429-6, SMPTE-430-12, SMPTE-429-19

A.3.95. 24 FPS test

Type	MXF pcm
Filename	24_fps_test_pcm_pt.mxf
Description	24 FPS Sound Track File where the words "left" and "right" are spoken (from the center speaker) as the

	pendulum of <i>2K 2D 24 FPS Test</i> reaches the extreme left and right of its trajectory, respectively.
Conforms to	[SMPTE-377-1], [SMPTE-429-3], [SMPTE-382]

A.3.96. 48 FPS test

Type	MXF pcm
Filename	48_fps_test_pcm_pt.mxf
Description	48 FPS Sound Track File where the words "left" and "right" are spoken (from the center speaker) as the pendulum of <i>2K 2D 48 FPS Test</i> reaches the extreme left and right of its trajectory, respectively.
Conforms to	[SMPTE-377-1], [SMPTE-429-3], [SMPTE-382]

A.3.97. 60 FPS test

Type	MXF pcm
Filename	60_fps_test_pcm_pt.mxf
Description	60 FPS Sound Track File where the words "left" and "right" are spoken (from the center speaker) as the pendulum of <i>2K 2D 60 FPS Test</i> reaches the extreme left and right of its trajectory, respectively.
Conforms to	[SMPTE-377-1], [SMPTE-429-3], [SMPTE-382]

A.3.98. 96 FPS test

Type	MXF pcm
Filename	96_fps_test_pcm_pt.mxf
Description	96 FPS Sound Track File where the words "left" and "right" are spoken (from the center speaker) as the pendulum of <i>2K 2D 96 FPS Test</i> reaches the extreme left and right of its trajectory, respectively.
Conforms to	[SMPTE-377-1], [SMPTE-429-3], [SMPTE-382]

A.3.99. 120 FPS test

Type	MXF pcm
Filename	120_fps_test_pcm_pt.mxf
Description	120 FPS Sound Track File where the words "left" and "right" are spoken (from the center speaker) as the pendulum of <i>2K 2D 120 FPS Test</i> reaches the extreme left and right of its trajectory, respectively.
Conforms to	[SMPTE-377-1], [SMPTE-429-3], [SMPTE-382]

A.4. D-Cinema Packages

A.4.1. Introduction

This section defines a set of D-Cinema Compositions and D-Cinema Packages. The Compositions depend upon the track files created in [Section A.2](#) and [Section A.3](#). The Packages contain the Compositions for ingest.

A.4.2. DCI 2K Sync Test

Type	CPL
Filename	2K_sync_test.cpl.xml
Conforms to	SMPTE-429-7
Prerequisites	<i>Sync Count, Sync Count 5.1</i>

A.4.3. DCI 2K Sync Test (Encrypted)

Type	CPL
Filename	2K_sync_test_ct.cpl.xml
Conforms to	SMPTE-429-7
Prerequisites	<i>Sync Count (Encrypted), Sync Count 5.1 (Encrypted)</i>

A.4.4. DCI 2K Sync test with Subtitles

Type	CPL
Filename	sync_test_with_subs.cpl.xml
Conforms to	SMPTE-429-7
Prerequisites	<i>Sync Count with Subtitle Reticles, Sync Count 5.1, Sync Count Text</i>

A.4.5. DCI 2K Sync test with Subtitles (Encrypted)

Type	CPL
Filename	sync_test_with_subs_ct.cpl.xml
Conforms to	SMPTE-429-7
Prerequisites	<i>Sync Count with Subtitle Reticles (Encrypted), Sync Count 5.1 (Encrypted), Sync Count Text (Encrypted)</i>

A.4.6. DCI 2K Sync Test (48fps)

Type	CPL	
Filename	sync_test_48fps.cpl.xml	
Conforms to	SMPTE-429-7	
Prerequisites	<i>Sync Count, 48fps, Sync Count 5.1 48fps</i>	
Meta	EditRate	48/1

A.4.7. 4K Sync Test

Type	CPL	
Filename	4K_sync_test.cpl.xml	
Conforms to	SMPTE-429-7	
Prerequisites	<i>4K Sync Count, Sync Count 5.1</i>	

A.4.8. DCI 5.1 Channel Identification

Type	CPL	
Filename	channel_id_51_pt.cpl.xml	
Conforms to	SMPTE-429-7	
Prerequisites	<i>Channel I.D. 5.1, Channel I.D. 5.1</i>	

A.4.9. DCI 1-16 Numbered Channel Identification

Type	CPL	
Filename	channel_id_01-16.cpl.xml	
Conforms to	SMPTE-429-7	
Prerequisites	<i>Channel I.D. 1-16, Channel I.D. 1-16</i>	

A.4.10. DCI NIST Frame with silence

Type	CPL	
Filename	nist_pattern_black_audio.cpl.xml	
Conforms to	SMPTE-429-7	
Prerequisites	<i>"NIST" 2K Test Pattern, Silence, 5.1</i>	

A.4.11. 4K DCI NIST Frame with silence

Type	CPL	
-------------	-----	--

Filename	4K_nist_pattern.cpl.xml
Conforms to	SMPTE-429-7
Prerequisites	"NIST" 4K Test Pattern, Silence, 5.1

A.4.12. DCI NIST Frame with Pink Noise

Type	CPL
Filename	nist_pattern_pink_noise.cpl.xml
Conforms to	SMPTE-429-7
Prerequisites	"NIST" 2K Test Pattern, Pink Noise, 16 Channels

A.4.13. DCI NIST Frame with 1 kHz tone (-20 dB fs)

Type	CPL
Filename	nist_pattern_1k.cpl.xml
Conforms to	SMPTE-429-7
Prerequisites	"NIST" 2K Test Pattern, 1 kHz Sine Wave

A.4.14. DCI NIST Frame with Pink Noise (96 kHz)

Type	CPL
Filename	nist_pattern_pink_noise_96k.cpl.xml
Conforms to	SMPTE-429-7
Prerequisites	"NIST" 2K Test Pattern, Pink Noise, 16 Channels, 96 kHz

A.4.15. DCI NIST Frame with 1 kHz tone (-20 dB fs, 96kHz)

Type	CPL
Filename	nist_pattern_1k_96k.cpl.xml
Conforms to	SMPTE-429-7
Prerequisites	"NIST" 2K Test Pattern, 1 kHz Sine Wave, 16 Channels 96kHz

A.4.16. DCI NIST Frame no sound files

Type	CPL
Filename	nist_pattern_no_audio.cpl.xml
Conforms to	SMPTE-429-7

Prerequisites	<i>"NIST" 2K Test Pattern</i>
----------------------	-------------------------------

A.4.17. DCI 2K Image with Frame Number Burn In

Type	CPL
Filename	frame_num_burn_in.cpl.xml
Conforms to	SMPTE-429-7
Prerequisites	<i>DCI Numbered Frame Sequence, Silence, 5.1, 15 minutes</i>

A.4.18. DCI 2K Image with Frame Number Burn In (Encrypted)

Type	CPL
Filename	frame_num_burn_in_ct.cpl.xml
Conforms to	SMPTE-429-7
Prerequisites	<i>DCI Numbered Frame Sequence (Encrypted), Silence, 5.1, 15 minutes (Encrypted)</i>

A.4.19. DCI 2K Image with Frame Number Burn In (Flat)

Type	CPL
Filename	frame_count_flat_2_reels.cpl.xml
Conforms to	SMPTE-429-7
Prerequisites	<i>DCI Flat Transition Sequence, Silence, 5.1</i>

A.4.20. DCI 2K Image with Frame Number Burn In (Scope)

Type	CPL
Filename	frame_count_scope_2_reels.cpl.xml
Conforms to	SMPTE-429-7
Prerequisites	<i>DCI Scope Transition Sequence, Silence, 5.1</i>

A.4.21. DCI 2K StEM

Type	CPL
Filename	2K_StEM_pt.cpl.xml
Description	A plaintext composition consisting of the StEM 2K image and 5.1 sound track files.
Conforms to	SMPTE-429-7
Prerequisites	<i>StEM 2K, StEM 5.1 Sound</i>

A.4.22. DCI 2K StEM (Encrypted)

Type	CPL
Filename	2K_StEM_ct.cpl.xml
Description	An encrypted composition consisting of the encrypted StEM 2K image and encrypted 5.1 sound track files.
Conforms to	SMPTE-429-7
Prerequisites	<i>StEM 2K (Encrypted), StEM 5.1 Sound (Encrypted)</i>

A.4.23. DCI 2K StEM Test Sequence

Type	CPL
Filename	2K_StEM_sequence_pt.cpl.xml
Description	A plaintext composition consisting of six (6) reels. Each reel is composed of the StEM 2K image and 5.1 sound track files.
Conforms to	SMPTE-429-7
Prerequisites	<i>StEM 2K, StEM 5.1 Sound</i>

A.4.24. DCI 2K StEM Test Sequence (Encrypted)

Type	CPL
Filename	2K_StEM_sequence_ct.cpl.xml
Description	An encrypted composition consisting of six (6) reels. Each reel is composed of the encrypted StEM 2K image and encrypted 5.1 sound track files.
Conforms to	SMPTE-429-7
Prerequisites	<i>StEM 2K (Encrypted), StEM 5.1 Sound (Encrypted)</i>

A.4.25. DCI 2K 48fps StEM

Type	CPL
Filename	2K_StEM_48fps_pt.cpl.xml
Description	A plaintext composition consisting of the StEM 2K 48 fps image and 5.1 sound track files.
Conforms to	SMPTE-429-7
Prerequisites	<i>StEM 2K 48 fps, StEM 48fps 5.1 Sound</i>

A.4.26. 128 Reel Composition, "A" Series

Type	CPL
-------------	-----

Filename	2K_StEM_128_a_reels_pt.cpl.xml
Description	A plaintext composition consisting of one hundred and twenty eight (128) reels. Each reel is composed of part of the plaintext StEM 2K image and plaintext 5.1 sound track files.
Conforms to	SMPTE-429-7
Prerequisites	<i>StEM 2K Multi-Reel A, StEM 5.1 Sound Multi-Reel A</i>

A.4.27. 128 Reel Composition, "B" Series

Type	CPL
Filename	2K_StEM_128_b_reels_pt.cpl.xml
Description	A plaintext composition consisting of one hundred and twenty eight (128) reels. Each reel is composed of part of the plaintext StEM 2K image and plaintext 5.1 sound track files.
Conforms to	SMPTE-429-7
Prerequisites	<i>StEM 2K Multi-Reel B, StEM 5.1 Sound Multi-Reel B</i>

A.4.28. 128 Reel Composition, "A" Series (Encrypted)

Type	CPL
Filename	2K_StEM_128_a_reels_ct.cpl.xml
Description	An encrypted composition consisting of one hundred and twenty eight (128) reels. Each reel is composed of part of the encrypted StEM 2K image and encrypted 5.1 sound track files.
Conforms to	SMPTE-429-7
Prerequisites	<i>StEM 2K Multi-Reel A (Encrypted), StEM 5.1 Sound Multi-Reel A (Encrypted)</i>

A.4.29. 128 Reel Composition, "B" Series (Encrypted)

Type	CPL
Filename	2K_StEM_128_b_reels_ct.cpl.xml
Description	An encrypted composition consisting of one hundred and twenty eight (128) reels. Each reel is composed of part of the encrypted StEM 2K image and encrypted 5.1 sound track files.
Conforms to	SMPTE-429-7
Prerequisites	<i>StEM 2K Multi-Reel B (Encrypted), StEM 5.1 Sound Multi-Reel B (Encrypted)</i>

A.4.30. 64 Reel Composition, 1 Second Reels (Encrypted)

Type	CPL
Filename	2K_StEM_64_1_second_reels_ct.cpl.xml

Description	An encrypted composition consisting of sixty four (64) reels, each with a duration of 1 second. Each reel is composed of part of the encrypted StEM 2K image and encrypted 5.1 sound track files.
Conforms to	SMPTE-429-7
Prerequisites	<i>StEM 2K Multi-Reel C (Encrypted), StEM 5.1 Sound Multi-Reel C (Encrypted)</i>

A.4.31. 2K FM Application Constraints (Encrypted)

Type	CPL
Filename	2K_fm_constraints_ct.cpl.xml
Description	A composition consisting of FM testing instructions and both encrypted and plaintext StEM 2K image and 16 channel WTF format sound track files.
Conforms to	SMPTE-429-7
Prerequisites	<i>FM Constraints Begin (Plaintext), FM Constraints Begin (Encrypted), FM Constraints End (Plaintext), FM Constraints End (Encrypted), 400 hz sine wave, WTF (Encrypted), 400 hz sine wave, WTF, StEM 2K (Encrypted), StEM 2K, FM StEM WTF Sound, FM StEM WTF Sound (Encrypted)</i>

A.4.32. 2K FM Control Granularity - No FM (Encrypted)

Type	CPL
Filename	2K_fm_control_granularity_no_fm.cpl.xml
Description	An encrypted composition containing the encrypted StEM 2K image and encrypted 16 channel WTF format sound track files.
Conforms to	SMPTE-429-7
Prerequisites	<i>2K FM Control Granularity Begin (Encrypted), 2K FM Control Granularity End (Encrypted), 400 hz sine wave, WTF (Encrypted), StEM 2K (Encrypted), FM StEM WTF Sound (Encrypted)</i>

A.4.33. 2K FM Control Granularity - Image Only FM (Encrypted)

Type	CPL
Filename	2K_fm_control_granularity_image_only_fm.cpl.xml
Description	An encrypted composition containing the FM encrypted StEM 2K image and encrypted 16 channel WTF format sound track files.
Conforms to	SMPTE-429-7
Prerequisites	<i>2K FM Control Granularity Begin (Encrypted), 2K FM Control Granularity End (Encrypted), 400 hz sine wave, WTF (Encrypted), StEM 2K (Encrypted), FM StEM WTF Sound (Encrypted)</i>

A.4.34. 2K FM Control Granularity - Sound Only FM (Encrypted)

Type	CPL
-------------	-----

Filename	2K_fm_control_granularity_sound_only_fm.cpl.xml
Description	An encrypted composition containing the encrypted StEM 2K image and encrypted 16 channel WTF format sound track files.
Conforms to	SMPTE-429-7
Prerequisites	<i>2K FM Control Granularity Begin (Encrypted), 2K FM Control Granularity End (Encrypted), 400 hz sine wave, WTF (Encrypted), StEM 2K (Encrypted), FM StEM WTF Sound (Encrypted)</i>

A.4.35. 2K FM Control Granularity - Image and Sound FM (Encrypted)

Type	CPL
Filename	2K_fm_control_granularity_image_and_sound_fm.cpl.xml
Description	An encrypted composition containing of the encrypted StEM 2K image and encrypted 16 channel WTF format sound track files.
Conforms to	SMPTE-429-7
Prerequisites	<i>2K FM Control Granularity Begin (Encrypted), 2K FM Control Granularity End (Encrypted), 400 hz sine wave, WTF (Encrypted), StEM 2K (Encrypted), FM StEM WTF Sound (Encrypted)</i>

A.4.36. 2K FM Payload (Encrypted)

Type	CPL
Filename	2K_fm_payload_ct.cpl.xml
Description	An encrypted composition for FM detection containing the encrypted StEM 2K image and encrypted 16 channel WTF format sound track files.
Conforms to	SMPTE-429-7
Prerequisites	<i>2K FM Payload Begin (Encrypted), 2K FM Payload End (Encrypted), 400 hz sine wave, WTF (Encrypted), StEM 2K (Encrypted), FM StEM WTF Sound (Encrypted)</i>

A.4.37. Binary Audio Forensic Marking Bypass Test (Encrypted)

Type	CPL
Filename	binary_audio_fm_ct.cpl.xml
Description	An encrypted composition containing an encrypted 48 kHz sound track file with 16 channels of audio in WTF format.
Conforms to	SMPTE-429-7
Prerequisites	<i>Binary Audio FM Bypass, Binary Audio FM Bypass WTF Sound (Encrypted)</i>

A.4.38. Selective Audio FM - All FM (Encrypted)

Type	CPL
Filename	selective_audio_fm_all-fm_ct.cpl.xml
Description	An encrypted composition containing an encrypted sound track file with 16 channels of audio.
Conforms to	SMPTE-429-7
Prerequisites	<i>Selective FM Begin, Selective FM End, 400 hz sine wave, WTF (Encrypted), StEM 2K, FM StEM WTF Sound (Encrypted)</i>

A.4.39. Selective Audio FM - No FM (Encrypted)

Type	CPL
Filename	selective_audio_fm_no-fm_ct.cpl.xml
Description	An encrypted composition containing an encrypted sound track file with 16 channels of audio.
Conforms to	SMPTE-429-7
Prerequisites	<i>Selective FM Begin, Selective FM End, 400 hz sine wave, WTF (Encrypted), StEM 2K, FM StEM WTF Sound (Encrypted)</i>

A.4.40. Selective Audio FM - Not Above Channel 6 (Encrypted)

Type	CPL
Filename	selective_audio_fm_6ch_ct.cpl.xml
Description	An encrypted composition containing an encrypted sound track file with 16 channels of audio.
Conforms to	SMPTE-429-7
Prerequisites	<i>Selective FM Begin, Selective FM End, 400 hz sine wave, WTF (Encrypted), StEM 2K, FM StEM WTF Sound (Encrypted)</i>

A.4.41. Selective Audio FM - Not Above Channel 8 (Encrypted)

Type	CPL
Filename	selective_audio_fm_8ch_ct.cpl.xml
Description	An encrypted composition containing an encrypted sound track file with 16 channels of audio.
Conforms to	SMPTE-429-7
Prerequisites	<i>Selective FM Begin, Selective FM End, 400 hz sine wave, WTF (Encrypted), StEM 2K, FM StEM WTF Sound (Encrypted)</i>

A.4.42. Selective Audio FM - Not Above Channel 10 (Encrypted)

Type	CPL
-------------	-----

Filename	selective_audio_fm_10ch_ct.cpl.xml
Description	An encrypted composition containing an encrypted sound track file with 16 channels of audio.
Conforms to	SMPTE-429-7
Prerequisites	<i>Selective FM Begin, Selective FM End, 400 hz sine wave, WTF (Encrypted), StEM 2K, FM StEM WTF Sound (Encrypted)</i>

A.4.43. Selective Audio FM - Not Above Channel 17 (Encrypted)

Type	CPL
Filename	selective_audio_fm_17ch_ct.cpl.xml
Description	An encrypted composition containing an encrypted sound track file with 16 channels of audio.
Conforms to	SMPTE-429-7
Prerequisites	<i>Selective FM Begin, Selective FM End, 400 hz sine wave, WTF (Encrypted), StEM 2K, FM StEM WTF Sound (Encrypted)</i>

A.4.44. 2K DCI Maximum Bitrate Composition (Encrypted)

Type	CPL
Filename	2K_max_bitrate_ct.cpl.xml
Description	Encrypted composition containing picture and sound track files of the maximum allowable bitrate.
Conforms to	SMPTE-429-7
Prerequisites	<i>2K Picture Track File, Maximum Bitrate, Maximum Bitrate, 16 Channels, 96 kHz (Encrypted)</i>

A.4.45. 4K DCI Maximum Bitrate Composition (Encrypted)

Type	CPL
Filename	4K_max_bitrate_ct.cpl.xml
Description	Encrypted composition containing picture and sound track files of the maximum allowable bitrate.
Conforms to	SMPTE-429-7
Prerequisites	<i>4K Picture Track File, Maximum Bitrate, Maximum Bitrate, 16 Channels, 96 kHz (Encrypted)</i>

A.4.46. End of Engagement - Past Time Window Extension (Encrypted)

Type	CPL
Filename	holdover_long_ct.cpl.xml
Description	An encrypted composition with duration of 6 hours and 11 minutes.

Conforms to	SMPTE-429-7
Prerequisites	<i>StEM 2K (Encrypted), StEM 5.1 Sound (Encrypted)</i>

A.4.47. End of Engagement - Within Time Window Extension (Encrypted)

Type	CPL
Filename	holdover_short_ct.cpl.xml
Description	An encrypted composition with duration of 5 hours and 59 minutes and 30 seconds.
Conforms to	SMPTE-429-7
Prerequisites	<i>StEM 2K (Encrypted), StEM 5.1 Sound (Encrypted)</i>

A.4.48. Deleted Section

The section "Multi-line Subtitle Test" was deleted. The section number is maintained here to preserve the numbering of subsequent sections.

A.4.49. Deleted Section

The section "Multi-line PNG Subtitle Test" was deleted. The section number is maintained here to preserve the numbering of subsequent sections.

A.4.50. Deleted Section

The section "Subtitle Test Part 1" was deleted. The section number is maintained here to preserve the numbering of subsequent sections.

A.4.51. Deleted Section

The section "Subtitle Test Part 2" was deleted. The section number is maintained here to preserve the numbering of subsequent sections.

A.4.52. Deleted Section

The section "Subtitle Test Part 3" was deleted. The section number is maintained here to preserve the numbering of subsequent sections.

A.4.53. DCI Black Spacer - 5 seconds

Type	CPL
Filename	black_spacer_5s.cpl.xml
Conforms to	SMPTE-429-7
Prerequisites	<i>Black (Empty Frame), Silence, 5.1</i>

A.4.54. White Frame Sequence

Type	CPL
-------------	-----

Filename	white_pt.cpl.xml
Conforms to	SMPTE-429-7, SMPTE-431-1
Prerequisites	<i>White (White Frame), Silence, 5.1</i>

A.4.55. Intra-Frame Contrast Sequence

Type	CPL
Filename	checkerboard_pt.cpl.xml
Conforms to	SMPTE-429-7, SMPTE-431-2
Prerequisites	<i>Intra-Frame Contrast Sequence, Silence, 5.1</i>

A.4.56. Sequential Contrast and Uniformity Sequence

Type	CPL
Filename	sequential_contrast_pt.cpl.xml
Conforms to	SMPTE-429-7, SMPTE-431-2
Prerequisites	<i>Sequential Contrast Sequence, Silence, 5.1</i>

A.4.57. DCI Gray Steps

Type	CPL
Filename	gray_step.cpl.xml
Conforms to	SMPTE-429-7
Prerequisites	<i>Black to Gray Step Series, Silence, 5.1, 15 minutes</i>

A.4.58. DCI White Steps

Type	CPL
Filename	white_step.cpl.xml
Conforms to	SMPTE-429-7
Prerequisites	<i>Black to White Step Series, Silence, 5.1, 15 minutes</i>

A.4.59. DCI 2K Moving Gradient

Type	CPL
Filename	moving-gradient-white.cpl.xml
Conforms to	SMPTE-429-7

Prerequisites <i>DCI_gradient_step_s_white_j2c_pt, Silence, 5.1</i>
--

A.4.60. Deleted Section

The section "DCI 2K Moving Gradient" was deleted. The section number is maintained here to preserve the numbering of subsequent sections.

A.4.61. Color Accuracy Series

Type	CPL
Filename	color_accuracy_pt.cpl.xml
Description	Composition containing five seconds (120 frames) of a chart showing all color values for the test in Section 7.5.12: Color Accuracy . This is followed by 1 minute of each of the 12 color values as a full frame.
Conforms to	SMPTE-429-7
Prerequisites	<i>Color Accuracy Series, Silence, 5.1, 15 minutes</i>

A.4.62. 4K Color Accuracy Series

Type	CPL
Filename	4K_color_accuracy_pt.cpl.xml
Description	4K composition containing contents identical to Section A.4.61: Color Accuracy Series
Conforms to	SMPTE-429-7
Prerequisites	<i>4K Color Accuracy Series, Silence, 5.1, 15 minutes</i>

A.4.63. Pixel Structure Pattern N 2k

Type	CPL
Filename	pixel_structure_N_2k_pt.cpl.xml
Description	North-oriented pixel structure test pattern featuring 16 x 16 and 8 x 8 pixel patterns with binary position indicators. See 7.5.3. Imaging Device Pixel Count/Structure for description.
Conforms to	SMPTE-429-7, SMPTE-431-1
Prerequisites	<i>pixel_structure_N_2k_j2c_pt, Silence, 5.1</i>

A.4.64. Pixel Structure Pattern S 2k

Type	CPL
Filename	pixel_structure_S_2k_pt.cpl.xml
Description	South-oriented pixel structure test pattern featuring 16 x 16 and 8 x 8 pixel patterns with binary position indicators. See 7.5.3. Imaging Device Pixel Count/Structure for description.

Conforms to	SMPTE-429-7, SMPTE-431-1
Prerequisites	<i>pixel_structure_S_2k_j2c_pt, Silence, 5.1</i>

A.4.65. Pixel Structure Pattern E 2k

Type	CPL
Filename	pixel_structure_E_2k_pt.cpl.xml
Description	East-oriented pixel structure test pattern featuring 16 x 16 and 8 x 8 pixel patterns with binary position indicators. See 7.5.3. Imaging Device Pixel Count/Structure for description.
Conforms to	SMPTE-429-7, SMPTE-431-1
Prerequisites	<i>pixel_structure_E_2k_j2c_pt, Silence, 5.1</i>

A.4.66. Pixel Structure Pattern W 2k

Type	CPL
Filename	pixel_structure_W_2k_pt.cpl.xml
Description	West-oriented pixel structure test pattern featuring 16 x 16 and 8 x 8 pixel patterns with binary position indicators. See 7.5.3. Imaging Device Pixel Count/Structure for description.
Conforms to	SMPTE-429-7, SMPTE-431-1
Prerequisites	<i>pixel_structure_W_2k_j2c_pt, Silence, 5.1</i>

A.4.67. Pixel Structure Pattern N 4k

Type	CPL
Filename	pixel_structure_N_4k_pt.cpl.xml
Description	North-oriented pixel structure test pattern featuring 16 x 16 pixel patterns with binary position indicators. See 7.5.3. Imaging Device Pixel Count/Structure for description.
Conforms to	SMPTE-429-7, SMPTE-431-1
Prerequisites	<i>pixel_structure_N_4k_j2c_pt, Silence, 5.1</i>

A.4.68. Pixel Structure Pattern S 4k

Type	CPL
Filename	pixel_structure_S_4k_pt.cpl.xml
Description	South-oriented pixel structure test pattern featuring 16 x 16 pixel patterns with binary position indicators. See 7.5.3. Imaging Device Pixel Count/Structure for description.
Conforms to	SMPTE-429-7, SMPTE-431-1

Prerequisites	<i>pixel_structure_S_4k_j2c_pt, Silence, 5.1</i>
----------------------	--

A.4.69. Pixel Structure Pattern E 4k

Type	CPL
Filename	pixel_structure_E_4k_pt.cpl.xml
Description	East-oriented pixel structure test pattern featuring 16 x 16 pixel patterns with binary position indicators. See 7.5.3. Imaging Device Pixel Count/Structure for description.
Conforms to	SMPTE-429-7, SMPTE-431-1
Prerequisites	<i>pixel_structure_E_4k_j2c_pt, Silence, 5.1</i>

A.4.70. Pixel Structure Pattern W 4k

Type	CPL
Filename	pixel_structure_W_4k_pt.cpl.xml
Description	West-oriented pixel structure test pattern featuring 16 x 16 pixel patterns with binary position indicators. See 7.5.3. Imaging Device Pixel Count/Structure for description.
Conforms to	SMPTE-429-7, SMPTE-431-1
Prerequisites	<i>pixel_structure_W_4k_j2c_pt, Silence, 5.1</i>

A.4.71. DCI Malformed Test 1: Picture with Frame-out-of-order error (Encrypted)

Type	CPL
Filename	m01_pict_frame_oo_ct.cpl.xml
Conforms to	SMPTE-429-7
Prerequisites	<i>m01 Picture Frame Out Of Order (Encrypted), 400 hz sine wave</i>

A.4.72. DCI Malformed Test 2: Sound with Frame-out-of-order error (Encrypted)

Type	CPL
Filename	m02_snd_frame_oo_ct.cpl.xml
Conforms to	SMPTE-429-7
Prerequisites	<i>"NIST" 2K Test Pattern, m02 Sound Frame Out Of Order (Encrypted)</i>

A.4.73. DCI Malformed Test 3: Sound Splice Tests

Type	CPL
Filename	m03_snd_splc_test.cpl.xml

Conforms to	SMPTE-429-7
Prerequisites	<i>m03 Sound Splice, 400 hz sine wave</i>

A.4.74. DCI Malformed Test 4: DCP With an incorrect audio TrackFile ID (Encrypted)

Type	CPL
Filename	m04_sndtk_wrong_file_ct.cpl.xml
Conforms to	SMPTE-429-7
Prerequisites	<i>"NIST" 2K Test Pattern, m04 Sound Track File With Wrong TrackFile ID (Encrypted)</i>

A.4.75. DCI Malformed Test 5: DCP With an incorrect image TrackFile ID (Encrypted)

Type	CPL
Filename	m05_pict_wrong_file_ct.cpl.xml
Conforms to	SMPTE-429-7
Prerequisites	<i>m05 Picture Track File With Wrong TrackFile ID (Encrypted), 400 hz sine wave</i>

A.4.76. DCI Malformed Test 6: CPL with incorrect track file hashes (Encrypted)

Type	CPL
Filename	m06_cpl_hash_error_ct.cpl.xml
Description	The contents of Asset Hash elements are replaced with random values.
Conforms to	SMPTE-429-7
Prerequisites	<i>StEM 2K (Encrypted), StEM 5.1 Sound (Encrypted)</i>
Meta	Signature no

A.4.77. DCI Malformed Test 7: CPL with an Invalid Signature (Encrypted)

Type	CPL
Filename	m07_cpl_invalid_signature_ct.cpl.xml
Conforms to	SMPTE-429-7
Prerequisites	<i>StEM 2K (Encrypted), StEM 5.1 Sound (Encrypted)</i>
Malformations	The contents of dsig:DigestValue are replaced with a random value.

A.4.78. DCI Malformed Test 8: DCP with timed text and a missing font

Type	CPL
-------------	-----

Filename	m08_dcp_timetext_missing_font_pt.cpl.xml
Conforms to	SMPTE-429-7
Prerequisites	<i>subtitle background, Silence, 5.1, Timed Text Example with Missing Font</i>

A.4.79. DCI Malformed Test 9: Picture with HMAC error in MXF Track File (Encrypted)

Type	CPL
Filename	m09_pict_bad_hmac_ct.cpl.xml
Conforms to	SMPTE-429-7
Prerequisites	<i>m09 Picture track file with bad HMAC (Encrypted), 400 hz sine wave</i>

A.4.80. DCI Malformed Test 10: Sound with HMAC error in MXF Track File (Encrypted)

Type	CPL
Filename	m10_snd_bad_hmac_ct.cpl.xml
Conforms to	SMPTE-429-7
Prerequisites	<i>"NIST" 2K Test Pattern, m10 Sound track file with bad HMAC (Encrypted)</i>

A.4.81. DCI Malformed Test 11: Picture with Check Value error in MXF Track File (Encrypted)

Type	CPL
Filename	m11_pict_bad_chuk_ct.cpl.xml
Conforms to	SMPTE-429-7
Prerequisites	<i>m11 Picture With Bad Check Value (Encrypted), 400 hz sine wave</i>

A.4.82. DCI Malformed Test 12: Sound with Check Value error in MXF Track File (Encrypted)

Type	CPL
Filename	m12_snd_bad_chuk_ct.cpl.xml
Conforms to	SMPTE-429-7
Prerequisites	<i>"NIST" 2K Test Pattern, m12 Sound Track File With Bad Check Value (Encrypted)</i>

A.4.83. DCI Malformed Test 13: CPL that references a non-existent track file (Encrypted)

Type	CPL
Filename	m13_cpl_missing_asset_ct.cpl.xml
Description	The MainSound asset of this composition is an reference to a non-existent track file.

Conforms to	SMPTE-429-7	
Prerequisites	<i>Sync Count (Encrypted)</i>	
Malformations	The Id element of the MainSound shall be a random value.	
Meta	Signature	no

A.4.84. DCI Malformed Test 14: CPL that does not conform to ST 429-7 (Encrypted)

Type	CPL	
Filename	m14_cpl_format_error_ct.cpl.xml	
Conforms to	SMPTE-429-7	
Prerequisites	<i>Sync Count (Encrypted), Sync Count 5.1 (Encrypted)</i>	
Malformations	Create valid CPL using an ad-hoc namespace name.	
Meta	Signature	no

A.4.85. DCI Malformed Test 15: CPL signed by a certificate not conforming to ST 430-2 (Encrypted)

Type	CPL	
Filename	m15_cpl_signer_format_error_ct.cpl.xml	
Conforms to	SMPTE-429-7	
Prerequisites	<i>Sync Count (Encrypted), Sync Count 5.1 (Encrypted)</i>	
Malformations	Create valid CPL signature using a SHA-1 certificate chain.	
Meta	Signature	no

A.4.86. DCI Malformed Test 16: CPL signed with No Role Certificate (Encrypted)

Type	CPL	
Filename	m16_cpl_malf_signer_no_role_ct.cpl.xml	
Description	A composition consisting of the encrypted StEM 2K image and encrypted 5.1 sound track files, signed with a certificate that has no role.	
Conforms to	SMPTE-429-7	
Prerequisites	<i>StEM 2K (Encrypted), StEM 5.1 Sound (Encrypted)</i>	
Malformations	The signer certificate of the CPL has no role instead of CS.	

Meta	Register	no
	Signature	no

A.4.87. DCI Malformed Test 17: CPL signed with Bad Role Certificate (Encrypted)

Type	CPL	
Filename	m17_cpl_malf_signer_bad_role_ct.cpl.xml	
Description	An encrypted composition consisting of the encrypted StEM 2K image and encrypted 5.1 sound track files, signed with a certificate with an incorrect role.	
Conforms to	SMPTE-429-7	
Prerequisites	<i>StEM 2K (Encrypted), StEM 5.1 Sound (Encrypted)</i>	
Malformations	The signer certificate of the CPL has the role of SM instead of CS.	
Meta	Register	no
	Signature	no

A.4.88. DCI Malformed Test 18: CPL signed with Extra Role Certificate (Encrypted)

Type	CPL	
Filename	m18_cpl_malf_signer_extra_role_ct.cpl.xml	
Description	An encrypted composition consisting of the encrypted StEM 2K image and encrypted 5.1 sound track files, signed with a certificate with an extra role.	
Conforms to	SMPTE-429-7	
Prerequisites	<i>StEM 2K (Encrypted), StEM 5.1 Sound (Encrypted)</i>	
Malformations	The signer certificate of the CPL has the roles of CS and SM instead of only CS.	
Meta	Register	no
	Signature	no

A.4.89. Deleted Section

The section "DCI DCP 2K (Encrypted)" was deleted. The section number is maintained here to preserve the numbering of subsequent sections.

A.4.90. DCI DCP 2K Multi-Reel 128 A (Encrypted)

Type	DCP	
Filename	DCI_2K_128_multi_a_tests	

Description	DCP containing 128 reel StEM, 5 seconds per reel, set A
Conforms to	SMPTE-429-8, SMPTE-429-9
Prerequisites	<i>128 Reel Composition, "A" Series (Encrypted)</i>

A.4.91. DCI DCP 2K Multi-Reel 128 B (Encrypted)

Type	DCP
Filename	DCI_2K_128_multi_b_tests
Description	DCP containing 128 reel StEM, 5 seconds per reel, set B
Conforms to	SMPTE-429-8, SMPTE-429-9
Prerequisites	<i>128 Reel Composition, "B" Series (Encrypted)</i>

A.4.92. DCI DCP 2K Multi-Reel 64 (Encrypted)

Type	DCP
Filename	DCI_2K_64_multi_tests
Description	DCP containing 64 reel StEM, 1 second per reel
Conforms to	SMPTE-429-8, SMPTE-429-9
Prerequisites	<i>64 Reel Composition, 1 Second Reels (Encrypted)</i>

A.4.93. DCI DCP 2K, Malformed (Encrypted)

Type	DCP
Filename	DCI_2K_malf
Description	DCP containing malformed test compositions
Conforms to	SMPTE-429-8, SMPTE-429-9
Prerequisites	<i>DCI Malformed Test 1: Picture with Frame-out-of-order error (Encrypted), DCI Malformed Test 2: Sound with Frame-out-of-order error (Encrypted), DCI Malformed Test 3: Sound Splice Tests, DCI Malformed Test 4: DCP With an incorrect audio TrackFile ID (Encrypted), DCI Malformed Test 5: DCP With an incorrect image TrackFile ID (Encrypted), DCI Malformed Test 6: CPL with incorrect track file hashes (Encrypted), DCI Malformed Test 7: CPL with an Invalid Signature (Encrypted), DCI Malformed Test 8: DCP with timed text and a missing font, DCI Malformed Test 9: Picture with HMAC error in MXF Track File (Encrypted), DCI Malformed Test 10: Sound with HMAC error in MXF Track File (Encrypted), DCI Malformed Test 11: Picture with Check Value error in MXF Track File (Encrypted), DCI Malformed Test 12: Sound with Check Value error in MXF Track File (Encrypted), DCI Malformed Test 13: CPL that references a non-existent track file (Encrypted), DCI Malformed Test 14: CPL that does not conform to ST 429-7 (Encrypted), DCI Malformed Test 15: CPL signed by a certificate not conforming to ST 430-2 (Encrypted), DCI Malformed Test 16: CPL signed with No Role Certificate (Encrypted), DCI Malformed</i>

	<i>Test 17: CPL signed with Bad Role Certificate (Encrypted), DCI Malformed Test 18: CPL signed with Extra Role Certificate (Encrypted)</i>	
Malformations	None	
Meta	yes	ExplicitPKLContents

A.4.94. DCI DCP 4K (Encrypted)

Type	DCP
Filename	DCI_4K_tests
Description	DCP containing well-formed 4K test compositions
Conforms to	SMPTE-429-8, SMPTE-429-9
Prerequisites	<i>4K Color Accuracy Series, 4K DCI Maximum Bitrate Composition (Encrypted), 4K DCI NIST Frame with silence, 4K Sync Test, Pixel Structure Pattern E 4k, Pixel Structure Pattern N 4k, Pixel Structure Pattern S 4k, Pixel Structure Pattern W 4k, 4K Scope Subtitle Test (Encrypted), 4K Flat Subtitle Test (Encrypted), 4K Full Subtitle Test (Encrypted)</i>

A.4.95. 2K Scope Subtitle Test (Encrypted)

Type	CPL
Filename	sub_test_2K_scope_ct.cpl.xml
Description	2K Scope Subtitle Test (Encrypted)
Conforms to	SMPTE-429-7, SMPTE-429-2
Prerequisites	<i>Silence, 5.1 (Encrypted), 2K Scope Subtitle Test Background - Reel 1, 2K Scope Subtitle Test - Timed Text track file - Reel 1, 2K Scope Subtitle Test Background - Reel 2, 2K Scope Subtitle Test - Timed Text track file - Reel 2, 2K Scope Subtitle Test Background - Reel 3, 2K Scope Subtitle Test - Timed Text track file - Reel 3, 2K Scope Subtitle Test Background - Reel 4, 2K Scope Subtitle Test - Timed Text track file - Reel 4, 2K Scope Subtitle Test Background - Reel 5, 2K Scope Subtitle Test - Timed Text track file - Reel 5, 2K Scope Subtitle Test Background - Reel 6, 2K Scope Subtitle Test - Timed Text track file - Reel 6, 2K Scope Subtitle Test Background - Reel 7, 2K Scope Subtitle Test - Timed Text track file - Reel 7, 2K Scope Subtitle Test Background - Reel 8, 2K Scope Subtitle Test - Timed Text track file - Reel 8, 2K Scope Subtitle Test Background - Reel 9, 2K Scope Subtitle Test - Timed Text track file - Reel 9, 2K Scope Subtitle Test Background - Reel 10, 2K Scope Subtitle Test - Timed Text track file - Reel 10</i>

A.4.96. 2K Flat Subtitle Test (Encrypted)

Type	CPL
Filename	sub_test_2K_flat_ct.cpl.xml
Description	2K Flat Subtitle Test (Encrypted)
Conforms to	SMPTE-429-7, SMPTE-429-2

Prerequisites	<i>Silence, 5.1 (Encrypted), 2K Flat Subtitle Test Background - Reel 1, 2K Flat Subtitle Test - Timed Text track file - Reel 1, 2K Flat Subtitle Test Background - Reel 2, 2K Flat Subtitle Test - Timed Text track file - Reel 2, 2K Flat Subtitle Test Background - Reel 3, 2K Flat Subtitle Test - Timed Text track file - Reel 3, 2K Flat Subtitle Test Background - Reel 4, 2K Flat Subtitle Test - Timed Text track file - Reel 4, 2K Flat Subtitle Test Background - Reel 5, 2K Flat Subtitle Test - Timed Text track file - Reel 5, 2K Flat Subtitle Test Background - Reel 6, 2K Flat Subtitle Test - Timed Text track file - Reel 6, 2K Flat Subtitle Test Background - Reel 7, 2K Flat Subtitle Test - Timed Text track file - Reel 7, 2K Flat Subtitle Test Background - Reel 8, 2K Flat Subtitle Test - Timed Text track file - Reel 8, 2K Flat Subtitle Test Background - Reel 9, 2K Flat Subtitle Test - Timed Text track file - Reel 9, 2K Flat Subtitle Test Background - Reel 10, 2K Flat Subtitle Test - Timed Text track file - Reel 10</i>
----------------------	---

A.4.97. 2K Full Subtitle Test (Encrypted)

Type	CPL
Filename	sub_test_2K_full_ct.cpl.xml
Description	2K Full Subtitle Test (Encrypted)
Conforms to	SMPTE-429-7, SMPTE-429-2
Prerequisites	<i>Silence, 5.1 (Encrypted), 2K Full Subtitle Test Background - Reel 1, 2K Full Subtitle Test - Timed Text track file - Reel 1, 2K Full Subtitle Test Background - Reel 2, 2K Full Subtitle Test - Timed Text track file - Reel 2, 2K Full Subtitle Test Background - Reel 3, 2K Full Subtitle Test - Timed Text track file - Reel 3, 2K Full Subtitle Test Background - Reel 4, 2K Full Subtitle Test - Timed Text track file - Reel 4, 2K Full Subtitle Test Background - Reel 5, 2K Full Subtitle Test - Timed Text track file - Reel 5, 2K Full Subtitle Test Background - Reel 6, 2K Full Subtitle Test - Timed Text track file - Reel 6, 2K Full Subtitle Test Background - Reel 7, 2K Full Subtitle Test - Timed Text track file - Reel 7, 2K Full Subtitle Test Background - Reel 8, 2K Full Subtitle Test - Timed Text track file - Reel 8, 2K Full Subtitle Test Background - Reel 9, 2K Full Subtitle Test - Timed Text track file - Reel 9, 2K Full Subtitle Test Background - Reel 10, 2K Full Subtitle Test - Timed Text track file - Reel 10</i>

A.4.98. 4K Scope Subtitle Test (Encrypted)

Type	CPL
Filename	sub_test_4K_scope_ct.cpl.xml
Description	4K Scope Subtitle Test (Encrypted)
Conforms to	SMPTE-429-7, SMPTE-429-2
Prerequisites	<i>Silence, 5.1 (Encrypted), 4K Scope Subtitle Test Background - Reel 1, 2K Scope Subtitle Test - Timed Text track file - Reel 1, 4K Scope Subtitle Test Background - Reel 2, 2K Scope Subtitle Test - Timed Text track file - Reel 2, 4K Scope Subtitle Test Background - Reel 3, 2K Scope Subtitle Test - Timed Text track file - Reel 3, 4K Scope Subtitle Test Background - Reel 4, 2K Scope Subtitle Test - Timed Text track file - Reel 4, 4K Scope Subtitle Test Background - Reel 5, 2K Scope Subtitle Test - Timed Text track file - Reel 5, 4K Scope Subtitle Test Background - Reel 6, 2K Scope Subtitle Test - Timed Text track file - Reel 6, 4K Scope Subtitle Test Background - Reel 7, 2K Scope Subtitle Test - Timed Text track file - Reel 7, 4K Scope Subtitle Test Background - Reel 8, 4K Scope Subtitle Test - Timed Text track file - Reel 8, 4K</i>

Scope Subtitle Test Background - Reel 9, 4K Scope Subtitle Test - Timed Text track file - Reel 9, 4K Scope Subtitle Test Background - Reel 10, 2k Scope Subtitle Test - Timed Text track file - Reel 10

A.4.99. 4K Flat Subtitle Test (Encrypted)

Type	CPL
Filename	sub_test_4K_flat_ct.cpl.xml
Description	4K Flat Subtitle Test (Encrypted)
Conforms to	SMPTE-429-7, SMPTE-429-2
Prerequisites	<i>Silence, 5.1 (Encrypted), 4K Flat Subtitle Test Background - Reel 1, 2K Flat Subtitle Test - Timed Text track file - Reel 1, 4K Flat Subtitle Test Background - Reel 2, 2K Flat Subtitle Test - Timed Text track file - Reel 2, 4K Flat Subtitle Test Background - Reel 3, 2K Flat Subtitle Test - Timed Text track file - Reel 3, 4K Flat Subtitle Test Background - Reel 4, 2K Flat Subtitle Test - Timed Text track file - Reel 4, 4K Flat Subtitle Test Background - Reel 5, 2K Flat Subtitle Test - Timed Text track file - Reel 5, 4K Flat Subtitle Test Background - Reel 6, 2K Flat Subtitle Test - Timed Text track file - Reel 6, 4K Flat Subtitle Test Background - Reel 7, 2K Flat Subtitle Test - Timed Text track file - Reel 7, 4K Flat Subtitle Test Background - Reel 8, 4K Flat Subtitle Test - Timed Text track file - Reel 8, 4K Flat Subtitle Test Background - Reel 9, 4K Flat Subtitle Test - Timed Text track file - Reel 9, 4K Flat Subtitle Test Background - Reel 10, 2K Flat Subtitle Test - Timed Text track file - Reel 10</i>

A.4.100. 4K Full Subtitle Test (Encrypted)

Type	CPL
Filename	sub_test_4K_full_ct.cpl.xml
Description	4K Full Subtitle Test (Encrypted)
Conforms to	SMPTE-429-7, SMPTE-429-2
Prerequisites	<i>Silence, 5.1 (Encrypted), 4K Full Subtitle Test Background - Reel 1, 2K Full Subtitle Test - Timed Text track file - Reel 1, 4K Full Subtitle Test Background - Reel 2, 2K Full Subtitle Test - Timed Text track file - Reel 2, 4K Full Subtitle Test Background - Reel 3, 2K Full Subtitle Test - Timed Text track file - Reel 3, 4K Full Subtitle Test Background - Reel 4, 2K Full Subtitle Test - Timed Text track file - Reel 4, 4K Full Subtitle Test Background - Reel 5, 2K Full Subtitle Test - Timed Text track file - Reel 5, 4K Full Subtitle Test Background - Reel 6, 2K Full Subtitle Test - Timed Text track file - Reel 6, 4K Full Subtitle Test Background - Reel 7, 2K Full Subtitle Test - Timed Text track file - Reel 7, 4K Full Subtitle Test Background - Reel 8, 4K Full Subtitle Test - Timed Text track file - Reel 8, 4K Full Subtitle Test Background - Reel 9, 4K Full Subtitle Test - Timed Text track file - Reel 9, 4K Full Subtitle Test Background - Reel 10, 2K Full Subtitle Test - Timed Text track file - Reel 10</i>

A.4.101. 2K 48fps Scope Subtitle Test (Encrypted)

Type	CPL
Filename	sub_test_48fps_scope_ct.cpl.xml
Description	2K 48fps Scope Subtitle Test (Encrypted)

Conforms to	SMPTE-429-7, SMPTE-429-2
Prerequisites	<i>Silence, 5.1, 48 fps (Encrypted), 2K 48fps Scope Subtitle Test Background - Reel 1, 2K 48fps Scope Subtitle Test - Timed Text track file - Reel 1, 2K 48fps Scope Subtitle Test Background - Reel 2, 48fps Scope Subtitle Test - Timed Text track file - Reel 2, 2K 48fps Scope Subtitle Test Background - Reel 3, 2K 48fps Scope Subtitle Test - Timed Text track file - Reel 3, 2K 48fps Scope Subtitle Test Background - Reel 4, 2K 48fps Scope Subtitle Test - Timed Text track file - Reel 4, 2K 48fps Scope Subtitle Test Background - Reel 5, 2K 48fps Scope Subtitle Test - Timed Text track file - Reel 5, 2K 48fps Scope Subtitle Test Background - Reel 6, 2K 48fps Scope Subtitle Test - Timed Text track file - Reel 6, 2K 48fps Scope Subtitle Test Background - Reel 7, 2K 48fps Scope Subtitle Test - Timed Text track file - Reel 7, 2K 48fps Scope Subtitle Test Background - Reel 8, 2K 48fps Scope Subtitle Test - Timed Text track file - Reel 8, 2K 48fps Scope Subtitle Test Background - Reel 9, 2K 48fps Scope Subtitle Test - Timed Text track file - Reel 9, 2K 48fps Scope Subtitle Test Background - Reel 10, 2K 48fps Scope Subtitle Test - Timed Text track file - Reel 10</i>

A.4.102. 2K 48fps Flat Subtitle Test (Encrypted)

Type	CPL
Filename	sub_test_48fps_flat_ct.cpl.xml
Description	2K 48fps Flat Subtitle Test (Encrypted)
Conforms to	SMPTE-429-7, SMPTE-429-2
Prerequisites	<i>Silence, 5.1, 48 fps (Encrypted), 2K 48fps Flat Subtitle Test Background - Reel 1, 2K 48fps Flat Subtitle Test - Timed Text track file - Reel 1, 2K 48fps Flat Subtitle Test Background - Reel 2, 2K 48fps Flat Subtitle Test - Timed Text track file - Reel 2, 2K 48fps Flat Subtitle Test Background - Reel 3, 2K 48fps Flat Subtitle Test - Timed Text track file - Reel 3, 2K 48fps Flat Subtitle Test Background - Reel 4, 2K 48fps Flat Subtitle Test - Timed Text track file - Reel 4, 2K 48fps Flat Subtitle Test Background - Reel 5, 2K 48fps Flat Subtitle Test - Timed Text track file - Reel 5, 2K 48fps Flat Subtitle Test Background - Reel 6, 2K 48fps Flat Subtitle Test - Timed Text track file - Reel 6, 2K 48fps Flat Subtitle Test Background - Reel 7, 2K 48fps Flat Subtitle Test - Timed Text track file - Reel 7, 2K 48fps Flat Subtitle Test Background - Reel 8, 2K 48fps Flat Subtitle Test - Timed Text track file - Reel 8, 2K 48fps Flat Subtitle Test Background - Reel 9, 2K 48fps Flat Subtitle Test - Timed Text track file - Reel 9, 2K 48fps Flat Subtitle Test Background - Reel 10, 2K 48fps Flat Subtitle Test - Timed Text track file - Reel 10</i>

A.4.103. 2K 48fps Full Subtitle Test (Encrypted)

Type	CPL
Filename	sub_test_48fps_full_ct.cpl.xml
Description	2K 48fps Full Subtitle Test (Encrypted)
Conforms to	SMPTE-429-7, SMPTE-429-2
Prerequisites	<i>Silence, 5.1, 48 fps (Encrypted), 2K 48fps Full Subtitle Test Background - Reel 1, 2K 48fps Full Subtitle Test - Timed Text track file - Reel 1, 2K 48fps Full Subtitle Test Background - Reel 2, 2K 48fps Full Subtitle Test - Timed Text track file - Reel 2, 2K 48fps Full Subtitle Test Background - Reel 3, 2K 48fps Full Subtitle Test - Timed Text track file - Reel 3, 2K 48fps Full Subtitle Test Background - Reel 4, 2K 48fps Full Subtitle Test - Timed Text track file - Reel 4, 2K 48fps Full Subtitle Test Background - Reel 5</i>

2K 48fps Full Subtitle Test - Timed Text track file - Reel 5, 2K 48fps Full Subtitle Test Background - Reel 6, 2K 48fps Full Subtitle Test - Timed Text track file - Reel 6, 2K 48fps Full Subtitle Test Background - Reel 7, 2K 48fps Full Subtitle Test - Timed Text track file - Reel 7, 2K 48fps Full Subtitle Test Background - Reel 8, 2K 48fps Full Subtitle Test - Timed Text track file - Reel 8, 2K 48fps Full Subtitle Test Background - Reel 9, 2K 48fps Full Subtitle Test - Timed Text track file - Reel 9, 2K 48fps Full Subtitle Test Background - Reel 10, 2K 48fps Full Subtitle Test - Timed Text track file - Reel 10

A.4.104. DCI DCP 2K Multi-Reel 128 A (Unencrypted)

Type	DCP
Filename	DCI_2K_128_multi_a_tests_pt
Description	DCP containing 128 reel StEM, 5 seconds per reel, set A, Unencrypted
Conforms to	SMPTE-429-8, SMPTE-429-9
Prerequisites	<i>128 Reel Composition, "A" Series</i>
Malformations	None

A.4.105. DCI DCP 2K Multi-Reel 128 B (Unencrypted)

Type	DCP
Filename	DCI_2K_128_multi_b_tests_pt
Description	DCP containing 128 reel StEM, 5 seconds per reel, set B, Unencrypted
Conforms to	SMPTE-429-8, SMPTE-429-9
Prerequisites	<i>128 Reel Composition, "B" Series</i>

A.4.106. DCI 2K Sync Test (OBAE)

Type	CPL
Filename	2K_sync_test_obae.cpl.xml
Description	A Composition that contains an Immersive Audio Track, as specified in SMPTE ST 429-18. It is intended to facilitate test procedures where timing measurements are performed.
Conforms to	SMPTE-429-7, SMPTE-429-19
Prerequisites	<i>Sync Count, Main Sound for Sync Count OBAE, Sync Count OBAE</i>

A.4.107. DCI 2K Sync Test (OBAE) (Encrypted)

Type	CPL
Filename	2K_sync_test_obae_ct.cpl.xml
Description	Encrypted version of Section A.4.106: DCI 2K Sync Test (OBAE)

Conforms to	SMPTE-429-7, SMPTE-429-19
Prerequisites	<i>Sync Count (Encrypted), Main Sound for Sync Count OBAE (Encrypted), Sync Count OBAE (Encrypted)</i>

A.4.108. DCI 2K StEM (OBAE)

Type	CPL
Filename	2K_StEM_obae_pt.cpl.xml
Description	A plaintext composition consisting of the StEM 2K image and an Immersive Audio Track, as specified in SMPTE ST 429-18.
Conforms to	SMPTE-429-7, SMPTE-429-19
Prerequisites	<i>StEM 2K, Main Sound for StEM OBAE, StEM OBAE</i>

A.4.109. DCI 2K StEM (OBAE) (Encrypted)

Type	CPL
Filename	2K_StEM_obae_ct.cpl.xml
Description	Encrypted version of Section A.4.108: DCI 2K StEM (OBAE)
Conforms to	SMPTE-429-7, SMPTE-429-19
Prerequisites	<i>StEM 2K (Encrypted), Main Sound for StEM OBAE (Encrypted), StEM OBAE (Encrypted)</i>

A.4.110. DCI 2K Sync Test with subtitles (OBAE)

Type	CPL
Filename	2K_sync_test_with_subs_obae.cpl.xml
Description	A Composition that contains an Immersive Audio and Subtitle Tracks. It is intended to facilitate test procedures where timing measurements are performed.
Conforms to	SMPTE-429-7, SMPTE-429-16, SMPTE-429-19
Prerequisites	<i>Sync Count with Subtitle Reticles, Main Sound for Sync Count OBAE, Sync Count OBAE, Sync Count Text</i>

A.4.111. DCI 2K Sync Test with subtitles (OBAE) (Encrypted)

Type	CPL
Filename	2K_sync_test_with_subs_obae_ct.cpl.xml
Description	Encrypted version of <i>DCI 2K Sync Test with subtitles (OBAE)</i>
Conforms to	SMPTE-429-7, SMPTE-429-16, SMPTE-429-19

Prerequisites	<i>Sync Count with Subtitle Reticles (Encrypted), Main Sound for Sync Count OBAE (Encrypted), Sync Count OBAE (Encrypted), Sync Count Text (Encrypted)</i>
----------------------	--

A.4.112. M25 Composition with Malformed Integrity Pack: Missing MIC item (Picture) (Encrypted)

Type	CPL
Filename	m25_integrity_pict_mic_ct.cpl.xml
Description	Composition where a MIC item is missing from the Main Picture Track File
Conforms to	SMPTE-429-7, SMPTE-429-16
Prerequisites	<i>M25 Picture Track File with Malformed Integrity Pack: Missing MIC item (Encrypted), Main Sound for StEM OBAE (Encrypted)</i>
Malformations	A MIC item is missing from the Main Picture Track File

A.4.113. M27 Composition with Malformed Integrity Pack: Missing TrackFileID item (Picture) (Encrypted)

Type	CPL
Filename	m27_integrity_pict_tfid_ct.cpl.xml
Description	Composition where a TrackFileID item is missing from the Main Picture Track File
Conforms to	SMPTE-429-7, SMPTE-429-16
Prerequisites	<i>M27 Picture Track File with Malformed Integrity Pack: Missing TrackFileID item (Encrypted), Main Sound for StEM OBAE (Encrypted)</i>
Malformations	A TrackFileID item is missing from the Main Picture Track File

A.4.114. M26 Composition with Malformed Integrity Pack: Missing SequenceNumber item (Picture) (Encrypted)

Type	CPL
Filename	m26_integrity_pict_snum_ct.cpl.xml
Description	Composition where a SequenceNumber item is missing from the Main Picture Track File
Conforms to	SMPTE-429-7, SMPTE-429-16
Prerequisites	<i>M26 Picture Track File with Malformed Integrity Pack: Missing SequenceNumber item (Encrypted), Sync Count 5.1 (Encrypted)</i>
Malformations	A SequenceNumber item is missing from the Main Picture Track File

A.4.115. M28 Composition with Malformed Integrity Pack: Missing MIC item (PCM) (Encrypted)

Type	CPL
Filename	m28_integrity_snd_mic_ct.cpl.xml
Description	Composition where a MIC item is missing from the Main Sound Track File
Conforms to	SMPTE-429-7, SMPTE-429-16
Prerequisites	<i>M28 Sound Track File with Malformed Integrity Pack: Missing MIC item (Encrypted), Sync Count (Encrypted)</i>
Malformations	A MIC item is missing from the Main Sound Track File

A.4.116. M30 Composition with Malformed Integrity Pack: Missing TrackFileID item (PCM) (Encrypted)

Type	CPL
Filename	m30_integrity_snd_tfid_ct.cpl.xml
Description	Composition where a TrackFileID item is missing from the Main Sound Track File
Conforms to	SMPTE-429-7, SMPTE-429-16
Prerequisites	<i>M30 Sound Track File with Malformed Integrity Pack: Missing TrackFileID item (Encrypted), Sync Count (Encrypted)</i>
Malformations	A TrackFileID item is missing from the Main Sound Track File

A.4.117. M29 Composition with Malformed Integrity Pack: Missing SequenceNumber item (PCM) (Encrypted)

Type	CPL
Filename	m29_integrity_snd_snum_ct.cpl.xml
Description	Composition where a SequenceNumber item is missing from the Main Sound Track File
Conforms to	SMPTE-429-7, SMPTE-429-16
Prerequisites	<i>M29 Sound Track File with Malformed Integrity Pack: Missing SequenceNumber item (Encrypted), Sync Count (Encrypted)</i>
Malformations	A SequenceNumber item is missing from the Main Sound Track File

A.4.118. M20 Composition with Malformed Integrity Pack: Missing MIC item (OBAE Main Sound) (Encrypted)

Type	CPL
Filename	m20_integrity_obae_ms_mic_ct.cpl.xml
Description	OBAE Composition where a MIC item is missing from the Main Sound Track File

Conforms to	SMPTE-429-7, SMPTE-429-16, SMPTE-429-19
Prerequisites	<i>M20 Sound Track File with Malformed Integrity Pack: Missing MIC item (OBAE) (Encrypted), Sync Count (Encrypted), Sync Count OBAE (Encrypted)</i>
Malformations	A MIC item is missing from the Main Sound Track File

A.4.119. M22 Composition with Malformed Integrity Pack: Missing TrackFileID item (OBAE Main Sound) (Encrypted)

Type	CPL
Filename	m22_integrity_obae_ms_tfid_ct.cpl.xml
Description	OBAE Composition where a TrackFileID item is missing from the Main Sound Track File
Conforms to	SMPTE-429-7, SMPTE-429-16, SMPTE-429-19
Prerequisites	<i>M22 Sound Track File with Malformed Integrity Pack: Missing TrackFileID item (OBAE) (Encrypted), Sync Count (Encrypted), Sync Count OBAE (Encrypted)</i>
Malformations	A TrackFileID item is missing from the Main Sound Track File

A.4.120. M21 Composition with Malformed Integrity Pack: Missing SequenceNumber item (OBAE Main Sound) (Encrypted)

Type	CPL
Filename	m21_integrity_obae_ms_snum_ct.cpl.xml
Description	OBAE Composition where a SequenceNumber item is missing from the Main Sound Track File
Conforms to	SMPTE-429-7, SMPTE-429-16, SMPTE-429-19
Prerequisites	<i>M21 Sound Track File with Malformed Integrity Pack: Missing SequenceNumber item (OBAE) (Encrypted), Sync Count (Encrypted), Sync Count OBAE (Encrypted)</i>
Malformations	A SequenceNumber item is missing from the Main Sound Track File

A.4.121. M19 Composition with Malformed Integrity Pack: Missing MIC item (OBAE) (Encrypted)

Type	CPL
Filename	m19_integrity_obae_mic_ct.cpl.xml
Description	OBAE Composition where a MIC item is missing from the OBAE Track File
Conforms to	SMPTE-429-7, SMPTE-429-16, SMPTE-429-19
Prerequisites	<i>M19 OBAE Track File with Malformed Integrity Pack: Missing MIC item (Encrypted), Sync Count (Encrypted), Main Sound for Sync Count OBAE (Encrypted)</i>

Malformations	A MIC item is missing from the OBAE Track File
----------------------	--

A.4.122. M24 Composition with Malformed Integrity Pack: Missing TrackFileID item (OBAE) (Encrypted)

Type	CPL
Filename	m24_integrity_obae_tfid_ct.cpl.xml
Description	OBAE Composition where a TrackFileID item is missing from the OBAE Track File
Conforms to	SMPTE-429-7, SMPTE-429-16, SMPTE-429-19
Prerequisites	<i>M24 OBAE Track File with Malformed Integrity Pack: Missing TrackFileID item (OBAE) (Encrypted), Sync Count (Encrypted), Main Sound for Sync Count OBAE (Encrypted)</i>
Malformations	A TrackFileID item is missing from the OBAE Track File

A.4.123. M23 Composition with Malformed Integrity Pack: Missing SequenceNumber item (OBAE) (Encrypted)

Type	CPL
Filename	m23_integrity_obae_snum_ct.cpl.xml
Description	OBAE Composition where a SequenceNumber item is missing from the OBAE Track File
Conforms to	SMPTE-429-7, SMPTE-429-16, SMPTE-429-19
Prerequisites	<i>M23 OBAE Track File with Malformed Integrity Pack: Missing SequenceNumber item (Encrypted), Sync Count (Encrypted), Main Sound for Sync Count OBAE (Encrypted)</i>
Malformations	A SequenceNumber item is missing from the OBAE Track File

A.4.124. 64 Reel Composition, 1 Second Reels (OBAE) (Encrypted)

Type	CPL
Filename	2K_StEM_64_1_second_reels_obae_ct.cpl.xml
Description	An encrypted OBAE composition consisting of sixty four (64) reels, each with a duration of 1 second. Each reel is composed of part of the encrypted StEM 2K image and encrypted OBAE track files.
Conforms to	SMPTE-429-7, SMPTE-429-16, SMPTE-429-19
Prerequisites	<i>StEM 2K Multi-Reel C (Encrypted), StEM OBAE Multi-Reel C (Encrypted), Main Sound for StEM OBAE Multi-Reel C (Encrypted)</i>

A.4.125. M40 OBAE DCP with Frame-out-of-order error (Encrypted)

Type	CPL
Filename	m40_obae_frame_oo_ct.cpl.xml

Conforms to	SMPTE-429-7, SMPTE-429-16, SMPTE-429-19
Prerequisites	<i>Sync Count (Encrypted), Main Sound for Sync Count OBAE (Encrypted), M40 OBAE Track File with Frame-out-of-order error (Encrypted)</i>

A.4.126. M41 OBAE DCP with an incorrect TrackFile ID (Encrypted)

Type	CPL
Filename	m41_obae_wrong_file_ct.cpl.xml
Conforms to	SMPTE-429-7, SMPTE-429-16, SMPTE-429-19
Prerequisites	<i>Sync Count (Encrypted), Main Sound for Sync Count OBAE (Encrypted), M41 OBAE Track File With Wrong TrackFile ID (Encrypted)</i>

A.4.127. DCI 2K Sync Test with MIC Key (OBAE) (Encrypted)

Type	CPL
Filename	2K_sync_test_obae_mkey_ct.cpl.xml
Description	Same as A.4.107. DCI 2K Sync Test (OBAE) (Encrypted) but with the OBAE Track File using a KDM-borne MIC Key.
Conforms to	SMPTE-429-7, SMPTE-429-16, SMPTE-429-19
Prerequisites	<i>Sync Count (Encrypted), Main Sound for Sync Count OBAE (Encrypted), Sync Count OBAE with MIC Key (Encrypted)</i>

A.4.128. M43 OBAE DCP with Check Value error in MXF Track File (Encrypted)

Type	CPL
Filename	m43_obae_bad_chuk_ct.cpl.xml
Conforms to	SMPTE-429-7, SMPTE-429-16, SMPTE-429-19
Prerequisites	<i>Sync Count (Encrypted), Main Sound for Sync Count OBAE (Encrypted), M43 OBAE Track File With Bad Check Value (Encrypted)</i>

A.4.129. End of Engagement - Past Time Window Extension (OBAE) (Encrypted)

Type	CPL
Filename	holdover_long_obae_ct.cpl.xml
Description	An encrypted OBAE composition with duration of 6 hours and 11 minutes.
Conforms to	SMPTE-429-7, SMPTE-429-16, SMPTE-429-19
Prerequisites	<i>StEM 2K (Encrypted), Main Sound for StEM OBAE (Encrypted), StEM OBAE (Encrypted)</i>

A.4.130. End of Engagement - Within Time Window Extension (OBAE) (Encrypted)

Type	CPL
Filename	holdover_short_obae_ct.cpl.xml
Description	An encrypted OBAE composition with duration of 5 hours and 59 minutes and 30 seconds.
Conforms to	SMPTE-429-7, SMPTE-429-16, SMPTE-429-19
Prerequisites	<i>StEM 2K (Encrypted), Main Sound for StEM OBAE (Encrypted), StEM OBAE (Encrypted)</i>

A.4.131. DCI 2K Sync Test with KDM-Borne MIC Keys (Encrypted)

Type	CPL
Filename	2K_sync_test_mkey_ct.cpl.xml
Description	Same as A.4.3. DCI 2K Sync Test (Encrypted) but with KDM-borne MIC Keys.
Conforms to	SMPTE-429-7
Prerequisites	<i>Sync Count 5.1 with KDM-Borne MIC Key (Encrypted), Sync Count with KDM-Borne MIC Key (Encrypted)</i>

A.4.132. M44 OBAE DCP with HMAC value error in MXF Track File (Encrypted)

Type	CPL
Filename	m44_obae_bad_hmac_ct.cpl.xml
Conforms to	SMPTE-429-7, SMPTE-429-16, SMPTE-429-19
Prerequisites	<i>Sync Count (Encrypted), Main Sound for Sync Count OBAE (Encrypted), M44 OBAE Track File With Bad HMAC Value (Encrypted)</i>

A.4.133. DCP for OBAE Tone Multi-Reel (Encrypted)

Type	CPL
Filename	OBAE_tone_multi_ct.cpl.xml
Conforms to	SMPTE-429-7, SMPTE-429-16, SMPTE-429-19
Prerequisites	<i>Sync Count (Encrypted), OBAE Tone Multi-Reel (Encrypted), Main Sound for OBAE Tone Multi-Reel (Encrypted)</i>

A.4.134. DCP for Audio Tone Multi-Reel (Encrypted)

Type	CPL
Filename	audio_tone_multi_ct.cpl.xml
Conforms to	SMPTE-429-7

Prerequisites	<i>Sync Count (Encrypted), Audio Tone Multi-Reel (Encrypted)</i>
----------------------	--

A.4.135. DCI 2K Sync Test (48fps) (OBAE)

Type	CPL
Filename	2K_sync_test_48fps_obae.cpl.xml
Description	A 48 fps Composition that contains an Immersive Audio Track, as specified in SMPTE ST 429-18. It is intended to facilitate test procedures where timing measurements are performed.
Conforms to	SMPTE-429-7, SMPTE-429-19
Prerequisites	<i>Sync Count, 48fps, Main Sound for Sync Count OBAE (48fps), Sync Count OBAE (48fps)</i>

A.4.136. 2K FM Application Constraints (OBAE) (Encrypted)

Type	CPL
Filename	2K_fm_constraints_obae_ct.cpl.xml
Description	A composition consisting of FM testing instructions and both encrypted and plaintext StEM 2K image and OBAE track files.
Conforms to	SMPTE-429-7, SMPTE-429-16, SMPTE-429-19
Prerequisites	<i>FM Constraints Begin (Plaintext), FM Constraints Begin (Encrypted), FM Constraints End (Plaintext), FM Constraints End (Encrypted), 400 hz sine wave (OBAE), 400 hz sine wave (OBAE) (Encrypted), Main Sound for 400 hz sine wave (OBAE), StEM 2K (Encrypted), StEM 2K, FM StEM OBAE, FM StEM OBAE (Encrypted), Main Sound for FM StEM OBAE</i>

A.4.137. 2K FM Control Granularity - No FM (OBAE) (Encrypted)

Type	CPL
Filename	2K_fm_control_granularity_no_fm_obae.cpl.xml
Description	An encrypted composition containing image and OBAE essence, for the purpose of detecting the forensic marking application.
Conforms to	SMPTE-429-7, SMPTE-429-16, SMPTE-429-19
Prerequisites	<i>2K FM Control Granularity Begin (Encrypted), 2K FM Control Granularity End (Encrypted), 400 hz sine wave (OBAE) (Encrypted), Main Sound for 400 hz sine wave (OBAE), StEM 2K (Encrypted), FM StEM OBAE (Encrypted), Main Sound for FM StEM OBAE</i>

A.4.138. 2K FM Control Granularity - Image Only FM (OBAE) (Encrypted)

Type	CPL
Filename	2K_fm_control_granularity_image_only_fm_obae.cpl.xml

Description	An encrypted composition containing image and OBAE essence, for the purpose of detecting the forensic marking application.
Conforms to	SMPTE-429-7, SMPTE-429-16, SMPTE-429-19
Prerequisites	<i>2K FM Control Granularity Begin (Encrypted), 2K FM Control Granularity End (Encrypted), 400 hz sine wave (OBAE) (Encrypted), Main Sound for 400 hz sine wave (OBAE), StEM 2K (Encrypted), FM StEM OBAE (Encrypted), Main Sound for FM StEM OBAE</i>

A.4.139. 2K FM Control Granularity - OBAE Only FM (OBAE) (Encrypted)

Type	CPL
Filename	2K_fm_control_granularity_obae_only_fm_obae.cpl.xml
Description	An encrypted composition containing image and OBAE essence, for the purpose of detecting the forensic marking application.
Conforms to	SMPTE-429-7, SMPTE-429-16, SMPTE-429-19
Prerequisites	<i>2K FM Control Granularity Begin (Encrypted), 2K FM Control Granularity End (Encrypted), 400 hz sine wave (OBAE) (Encrypted), Main Sound for 400 hz sine wave (OBAE), StEM 2K (Encrypted), FM StEM OBAE (Encrypted), Main Sound for FM StEM OBAE</i>

A.4.140. 2K FM Control Granularity - Image and OBAE FM (OBAE) (Encrypted)

Type	CPL
Filename	2K_fm_control_granularity_image_and_obae_fm_obae.cpl.xml
Description	An encrypted composition containing image and OBAE essence, for the purpose of detecting the forensic marking application.
Conforms to	SMPTE-429-7, SMPTE-429-16, SMPTE-429-19
Prerequisites	<i>2K FM Control Granularity Begin (Encrypted), 2K FM Control Granularity End (Encrypted), 400 hz sine wave (OBAE) (Encrypted), Main Sound for 400 hz sine wave (OBAE), StEM 2K (Encrypted), FM StEM OBAE (Encrypted), Main Sound for FM StEM OBAE</i>

A.4.141. 128 Reel Composition, "A" Series (OBAE)

Type	CPL
Filename	2K_StEM_128_a_reels_obae_pt.cpl.xml
Description	A plaintext composition consisting of one hundred and twenty eight (128) reels, where no two reels reference identical main picture, main sound or OBAE track files. The main picture, main sound and OBAE tracks are based on those of Section A.4.108: DCI 2K StEM (OBAE).
Conforms to	SMPTE-429-7, SMPTE-429-16, SMPTE-429-19
Prerequisites	<i>StEM 2K Multi-Reel A, StEM OBAE Multi-Reel A, Main Sound for StEM OBAE Multi-Reel A</i>

A.4.142. 128 Reel Composition, "B" Series (OBAE)

Type	CPL
Filename	2K_StEM_128_b_reels_obae_pt.cpl.xml
Description	A plaintext composition consisting of one hundred and twenty eight (128) reels, where no two reels reference identical main picture, main sound or OBAE track files. The main picture, main sound and OBAE tracks are based on those of Section A.4.108: DCI 2K StEM (OBAE) .
Conforms to	SMPTE-429-7, SMPTE-429-16, SMPTE-429-19
Prerequisites	<i>StEM 2K Multi-Reel B, StEM OBAE Multi-Reel B, Main Sound for StEM OBAE Multi-Reel B</i>

A.4.143. 128 Reel Composition, "A" Series (OBAE) (Encrypted)

Type	CPL
Filename	2K_StEM_128_a_reels_obae_ct.cpl.xml
Description	Encrypted version of A.4.141. 128 Reel Composition, "A" Series (OBAE) where 256 distinct cryptographic keys are used: 128 for the main picture track and 64 for each of the main sound and OBAE tracks.
Conforms to	SMPTE-429-7, SMPTE-429-16, SMPTE-429-19
Prerequisites	<i>StEM 2K Multi-Reel A (Encrypted), StEM OBAE Multi-Reel A (Encrypted), Main Sound for StEM OBAE Multi-Reel A (Encrypted)</i>

A.4.144. 128 Reel Composition, "B" Series (OBAE) (Encrypted)

Type	CPL
Filename	2K_StEM_128_b_reels_obae_ct.cpl.xml
Description	Encrypted version of A.4.142. 128 Reel Composition, "B" Series (OBAE) where 256 distinct cryptographic keys are used: 128 for the main picture track and 64 for each of the main sound and OBAE tracks.
Conforms to	SMPTE-429-7, SMPTE-429-16, SMPTE-429-19
Prerequisites	<i>StEM 2K Multi-Reel B (Encrypted), StEM OBAE Multi-Reel B (Encrypted), Main Sound for StEM OBAE Multi-Reel B (Encrypted)</i>

A.4.145. 2K FM Payload (OBAE) (Encrypted)

Type	CPL
Filename	2K_fm_payload_obae_ct.cpl.xml
Description	An encrypted composition for FM payload retrieval containing encrypted StEM 2K image and corresponding OBAE essence, preceded and followed by slates.
Conforms to	SMPTE-429-7, SMPTE-429-16, SMPTE-429-19

Prerequisites	<i>2K FM Payload Begin (Encrypted), 2K FM Payload End (Encrypted), 400 hz sine wave (OBAE) (Encrypted), Main Sound for 400 hz sine wave (OBAE), StEM 2K (Encrypted), Main Sound for FM StEM OBAE, FM StEM OBAE (Encrypted)</i>
----------------------	--

A.4.146. 2K FM Payload (plaintext OBAE) (Encrypted)

Type	CPL
Filename	2K_fm_payload_pt_obae_ct.cpl.xml
Description	A version of A.4.145. 2K FM Payload (OBAE) (Encrypted) where the OBAE essence is plaintext.
Conforms to	SMPTE-429-7, SMPTE-429-16, SMPTE-429-19
Prerequisites	<i>2K FM Payload Begin (Encrypted), 2K FM Payload End (Encrypted), 400 hz sine wave (OBAE), Main Sound for 400 hz sine wave (OBAE), StEM 2K (Encrypted), Main Sound for FM StEM OBAE, FM StEM OBAE</i>

A.4.147. Maximum Bitrate OBAE (Encrypted)

Type	CPL
Filename	maximum_bitrate_24Hz_obae_ct.cpl.xml
Description	A encrypted composition intended to exercise the maximum OBAE bitrate at a frame rate of 24 Hz.
Conforms to	SMPTE-429-7, SMPTE-429-16, SMPTE-429-19
Prerequisites	<i>StEM 2K, Maximum Bitrate OBAE (Encrypted), Main Sound for Maximum Bitrate OBAE (Encrypted)</i>

A.4.148. Maximum Bitrate OBAE 48 fps (Encrypted)

Type	CPL
Filename	maximum_bitrate_48Hz_obae_ct.cpl.xml
Description	A encrypted composition intended to exercise the maximum OBAE bitrate at a frame rate of 48 Hz.
Conforms to	SMPTE-429-7, SMPTE-429-16, SMPTE-429-19
Prerequisites	<i>StEM 2K 48 fps, Maximum Bitrate OBAE 48 fps (Encrypted), Main Sound for Maximum Bitrate OBAE 48 fps (Encrypted)</i>

A.4.149. OBAE Rendering Expectations

Type	CPL
Filename	obae_rendering_test_pt.cpl.xml
Description	Composition intended to evaluate whether OBAE rendering expectations are met. Some reels contain neither a sync signal nor OBAE Track Files.
Conforms to	SMPTE-429-7, SMPTE-429-16, SMPTE-429-18

Prerequisites	<i>OBAE Rendering Expectations Guide, OBAE Rendering Test, Main Sound for OBAE Rendering Test, Silence w/ HI/VI</i>
----------------------	---

A.4.150. DCI Malformed Test 6b: CPL with incorrect track file hashes (OBAE) (Encrypted)

Type	CPL
Filename	m06b_cpl_hash_error_obae_ct.cpl.xml
Description	The contents of Asset Hash elements are replaced with random values.
Conforms to	SMPTE-429-19
Prerequisites	<i>StEM 2K (Encrypted), Main Sound for StEM OBAE (Encrypted), StEM OBAE (Encrypted)</i>
Malformations	The contents of Asset Hash elements are replaced with random values.

A.4.151. DCI Malformed Test 7b: CPL with an Invalid Signature (OBAE) (Encrypted)

Type	CPL
Filename	m07b_cpl_invalid_signature_obae_ct.cpl.xml
Conforms to	SMPTE-429-19
Prerequisites	<i>StEM 2K (Encrypted), Main Sound for StEM OBAE (Encrypted), StEM OBAE (Encrypted)</i>
Malformations	The contents of dsig:DigestValue are replaced with a random value.

A.4.152. DCI Malformed Test 13b: CPL that references a non-existent track file (OBAE) (Encrypted)

Type	CPL
Filename	m13b_cpl_missing_asset_obae_ct.cpl.xml
Description	The MainSound asset of this composition is an reference to a non-existent track file.
Conforms to	SMPTE-429-19
Prerequisites	<i>Sync Count (Encrypted), Main Sound for Sync Count OBAE (Encrypted), Sync Count OBAE (Encrypted)</i>
Malformations	The Id element of the MainSound shall be a random value.

A.4.153. DCI Malformed Test 14b: CPL that does not conform to ST 429-7 (OBAE) (Encrypted)

Type	CPL
Filename	m14b_cpl_format_error_obae_ct.cpl.xml
Conforms to	SMPTE-429-19
Prerequisites	<i>Sync Count (Encrypted), Main Sound for Sync Count OBAE (Encrypted), Sync Count OBAE (Encrypted)</i>

Malformations	Create valid CPL using an ad-hoc namespace name.
----------------------	--

A.4.154. DCI Malformed Test 15b: CPL signed by a certificate not conforming to ST 430-2 (OBAE) (Encrypted)

Type	CPL
Filename	m15b_cpl_signer_format_error_obae_ct.cpl.xml
Conforms to	SMPTE-429-19
Prerequisites	<i>Sync Count (Encrypted), Main Sound for Sync Count OBAE (Encrypted), Sync Count OBAE (Encrypted)</i>
Malformations	Create valid CPL signature using a SHA-1 certificate chain.

A.4.155. DCI Malformed Test 16b: CPL signed with No Role Certificate (OBAE) (Encrypted)

Type	CPL
Filename	m16b_cpl_malf_signer_no_role_obae_ct.cpl.xml
Description	A composition signed with a certificate that has no role.
Conforms to	SMPTE-429-19
Prerequisites	<i>StEM 2K (Encrypted), Main Sound for StEM OBAE (Encrypted), StEM OBAE (Encrypted)</i>
Malformations	The signer certificate of the CPL has no role instead of CS.

A.4.156. DCI Malformed Test 17b: CPL signed with Bad Role Certificate (OBAE) (Encrypted)

Type	CPL
Filename	m17b_cpl_malf_signer_bad_role_obae_ct.cpl.xml
Description	An encrypted composition signed with a certificate with an incorrect role.
Conforms to	SMPTE-429-19
Prerequisites	<i>StEM 2K (Encrypted), Main Sound for StEM OBAE (Encrypted), StEM OBAE (Encrypted)</i>
Malformations	The signer certificate of the CPL has the role of SM instead of CS.

A.4.157. DCI Malformed Test 18b: CPL signed with Extra Role Certificate (OBAE) (Encrypted)

Type	CPL
Filename	m18b_cpl_malf_signer_extra_role_obae_ct.cpl.xml
Description	An encrypted composition signed with a certificate with an extra role.
Conforms to	SMPTE-429-19
Prerequisites	<i>StEM 2K (Encrypted), Main Sound for StEM OBAE (Encrypted), StEM OBAE (Encrypted)</i>

Malformations The signer certificate of the CPL has the roles of CS and SM instead of only CS.

A.4.158. OBAE Rendering Expectations (Clip)

Type	CPL
Filename	obae_rendering_test_clip_pt.cpl.xml
Description	First three reels of <i>OBAE Rendering Expectations</i>
Conforms to	SMPTE-429-7, SMPTE-429-16, SMPTE-429-18
Prerequisites	<i>OBAE Rendering Expectations</i>

A.4.159. DCI 2K Image with Frame Number Burn In (OBAE) (Encrypted)

Type	CPL
Filename	frame_num_burn_in_obae_ct.cpl.xml
Conforms to	SMPTE-429-7, SMPTE-429-16, SMPTE-429-18
Prerequisites	<i>DCI Numbered Frame Sequence (Encrypted)</i> , <i>Silence, OBAE, 15 minutes (Encrypted)</i> , <i>Main Sound for Silence, OBAE, 15 minutes (Encrypted)</i>

A.4.160. 2K DCI Maximum Bitrate Composition (OBAE) (Encrypted)

Type	CPL
Filename	2K_max_bitrate_obae_ct.cpl.xml
Description	Encrypted composition containing picture, sound and OBAE track files of the maximum allowable bitrate.
Conforms to	SMPTE-429-7, SMPTE-429-16, SMPTE-429-18
Prerequisites	<i>2K Picture Track File, Maximum Bitrate, Maximum Bitrate OBAE (Encrypted)</i> , <i>Main Sound for Maximum Bitrate OBAE (Encrypted)</i>

A.4.161. HDR Sequential Contrast and Uniformity Sequence

Type	CPL
Filename	sequential_contrast_hdr_pt.cpl.xml
Conforms to	[SMPTE-429-7], [DCI-HDR]
Prerequisites	<i>HDR Sequential Contrast Sequence, Silence, 5.1</i>

A.4.162. HDR Color Accuracy Series

Type	CPL
Filename	sequential_color_hdr_pt.cpl.xml

Description	Composition cycling through the Color Accuracy Color Patch Code Values specified in [DCI-HDR].
Conforms to	[SMPTE-429-7], [DCI-HDR]
Prerequisites	<i>4K HDR Color Accuracy Series, Silence, 5.1</i>

A.4.163. 2K Full SDR Black

Type	CPL
Filename	2k_full_sdr_black_pt.cpl.xml
Description	2K full SDR black composition where the MainPictureActiveArea item of the CPL is set to the dimensions of the encoded image.
Conforms to	[SMPTE-429-7], [SMPTE-429-16]
Prerequisites	<i>2K Full SDR Black, Silence, 5.1, 15 minutes</i>

A.4.164. 2K Scope SDR Black

Type	CPL
Filename	2k_scope_sdr_black_pt.cpl.xml
Description	2K scope SDR black composition where the MainPictureActiveArea item of the CPL is set to the dimensions of the encoded image.
Conforms to	[SMPTE-429-7], [SMPTE-429-16]
Prerequisites	<i>2K Scope SDR Black, Silence, 5.1, 15 minutes</i>

A.4.165. 2K Flat SDR Black

Type	CPL
Filename	2k_flat_sdr_black_pt.cpl.xml
Description	2K flat SDR black composition where the MainPictureActiveArea item of the CPL is set to the dimensions of the encoded image.
Conforms to	[SMPTE-429-7], [SMPTE-429-16]
Prerequisites	<i>2K Flat SDR Black, Silence, 5.1, 15 minutes</i>

A.4.166. 4K Full SDR Black

Type	CPL
Filename	4k_full_sdr_black_pt.cpl.xml
Description	4K full SDR black composition where the MainPictureActiveArea item of the CPL is set to the dimensions of the encoded image.

Conforms to	[SMPTE-429-7], [SMPTE-429-16]
Prerequisites	<i>4K Full SDR Black, Silence, 5.1, 15 minutes</i>

A.4.167. 4K Scope SDR Black

Type	CPL
Filename	4k_scope_sdr_black_pt.cpl.xml
Description	4K scope SDR black composition where the MainPictureActiveArea item of the CPL is set to the dimensions of the encoded image.
Conforms to	[SMPTE-429-7], [SMPTE-429-16]
Prerequisites	<i>4K Scope SDR Black, Silence, 5.1, 15 minutes</i>

A.4.168. 4K Flat SDR Black

Type	CPL
Filename	4k_flat_sdr_black_pt.cpl.xml
Description	4K flat SDR black composition where the MainPictureActiveArea item of the CPL is set to the dimensions of the encoded image.
Conforms to	[SMPTE-429-7], [SMPTE-429-16]
Prerequisites	<i>4K Flat SDR Black, Silence, 5.1, 15 minutes</i>

A.4.169. 2K Full SDR Black with Marks

Type	CPL
Filename	2k_full_sdr_black_marks_pt.cpl.xml
Description	2K full SDR black composition with registration marks. The MainPictureActiveArea item of the CPL is set to the dimensions of the encoded image.
Conforms to	[SMPTE-429-7], [SMPTE-429-16]
Prerequisites	<i>2K Full SDR Black with Marks, Silence, 5.1, 15 minutes</i>

A.4.170. 2K Scope SDR Black with Marks

Type	CPL
Filename	2k_scope_sdr_black_marks_pt.cpl.xml
Description	2K scope SDR black composition with registration marks. The MainPictureActiveArea item of the CPL is set to the dimensions of the encoded image.
Conforms to	[SMPTE-429-7], [SMPTE-429-16]

Prerequisites	<i>2K Scope SDR Black with Marks, Silence, 5.1, 15 minutes</i>
----------------------	--

A.4.171. 2K Flat SDR Black with Marks

Type	CPL
Filename	2k_flat_sdr_black_marks_pt.cpl.xml
Description	2K flat SDR black composition with registration marks. The MainPictureActiveArea item of the CPL is set to the dimensions of the encoded image.
Conforms to	[SMPTE-429-7], [SMPTE-429-16]
Prerequisites	<i>2K Flat SDR Black with Marks, Silence, 5.1, 15 minutes</i>

A.4.172. 4K Full SDR Black with Marks

Type	CPL
Filename	4k_full_sdr_black_marks_pt.cpl.xml
Description	4K full SDR black composition with registration marks. The MainPictureActiveArea item of the CPL is set to the dimensions of the encoded image.
Conforms to	[SMPTE-429-7], [SMPTE-429-16]
Prerequisites	<i>4K Full SDR Black with Marks, Silence, 5.1, 15 minutes</i>

A.4.173. 4K Scope SDR Black with Marks

Type	CPL
Filename	4k_scope_sdr_black_marks_pt.cpl.xml
Description	4K scope SDR black composition with registration marks. The MainPictureActiveArea item of the CPL is set to the dimensions of the encoded image.
Conforms to	[SMPTE-429-7], [SMPTE-429-16]
Prerequisites	<i>4K Scope SDR Black with Marks, Silence, 5.1, 15 minutes</i>

A.4.174. 4K Flat SDR Black with Marks

Type	CPL
Filename	4k_flat_sdr_black_marks_pt.cpl.xml
Description	4K flat SDR black composition with registration marks. The MainPictureActiveArea item of the CPL is set to the dimensions of the encoded image.
Conforms to	[SMPTE-429-7], [SMPTE-429-16]
Prerequisites	<i>4K Flat SDR Black with Marks, Silence, 5.1, 15 minutes</i>

A.4.175. 2K Full SDR Black with Active Area

Type	CPL
Filename	2k_full_sdr_black_active_pt.cpl.xml
Description	2K full SDR composition with an active area indicated by registration marks and specified by the MainPictureActiveArea item of the CPL.
Conforms to	[SMPTE-429-7], [SMPTE-429-16]
Prerequisites	<i>2K Full SDR Black with Active Area, Silence, 5.1, 15 minutes</i>

A.4.176. 2K Scope SDR Black with Active Area

Type	CPL
Filename	2k_scope_sdr_black_active_pt.cpl.xml
Description	2K scope SDR composition with an active area indicated by registration marks and specified by the MainPictureActiveArea item of the CPL.
Conforms to	[SMPTE-429-7], [SMPTE-429-16]
Prerequisites	<i>2K Scope SDR Black with Active Area, Silence, 5.1, 15 minutes</i>

A.4.177. 2K Flat SDR Black with Active Area

Type	CPL
Filename	2k_flat_sdr_black_active_pt.cpl.xml
Description	2K flat SDR with an active area indicated by registration marks and specified by the MainPictureActiveArea item of the CPL.
Conforms to	[SMPTE-429-7], [SMPTE-429-16]
Prerequisites	<i>2K Flat SDR Black with Active Area, Silence, 5.1, 15 minutes</i>

A.4.178. 4K Full SDR Black with Active Area

Type	CPL
Filename	4k_full_sdr_black_active_pt.cpl.xml
Description	4K full SDR with an active area indicated by registration marks and specified by the MainPictureActiveArea item of the CPL.
Conforms to	[SMPTE-429-7], [SMPTE-429-16]
Prerequisites	<i>4K Full SDR Black with Active Area, Silence, 5.1, 15 minutes</i>

A.4.179. 4K Scope SDR Black with Active Area

Type	CPL
Filename	4k_scope_sdr_black_active_pt.cpl.xml
Description	4K scope SDR with an active area indicated by registration marks and specified by the MainPictureActiveArea item of the CPL.
Conforms to	[SMPTE-429-7], [SMPTE-429-16]
Prerequisites	<i>4K Scope SDR Black with Active Area, Silence, 5.1, 15 minutes</i>

A.4.180. 4K Flat SDR Black with Active Area

Type	CPL
Filename	4k_flat_sdr_black_active_pt.cpl.xml
Description	4K flat SDR with an active area indicated by registration marks and specified by the MainPictureActiveArea item of the CPL.
Conforms to	[SMPTE-429-7], [SMPTE-429-16]
Prerequisites	<i>4K Flat SDR Black with Active Area, Silence, 5.1, 15 minutes</i>

A.4.181. Stereoscopic SDR Contrast Test Patterns

Type	CPL
Filename	sdr_contrast_stereo_pt.cpl.xml
Description	Sequence of full-screen white and black frames designed to evaluate the stereoscopic contrast performance of the Imaging Device.
Conforms to	[SMPTE-429-7], [SMPTE-429-10], [SMPTE-429-16]
Prerequisites	<i>SDR Stereoscopic Contrast Test Patterns, Silence, 5.1, 15 minutes</i>

A.4.182. 4K Scaling Test Patterns

Type	CPL
Filename	4k_scaling_patterns_pt.cpl.xml
Description	Static presentation of thin lines for the purpose of detecting scaling artifacts.
Conforms to	[SMPTE-429-7], [SMPTE-429-10], [SMPTE-429-16]
Prerequisites	<i>4K SDR Scaling Test Pattern, Silence, 5.1, 15 minutes</i>

A.4.183. Stereoscopic Color Accuracy Series

Type	CPL
Filename	color_accuracy_stereo_pt.cpl.xml

Description	Stereoscopic Composition that displays the color patches illustrated at A.2.12. Color Accuracy Series .
Conforms to	SMPTE-429-2, SMPTE-429-7, SMPTE-429-10
Prerequisites	<i>Stereoscopic Color Accuracy Series, Silence, 5.1, 15 minutes</i>

A.4.184. 4K White Lines

Type	CPL
Filename	white_lines_pt.cpl.xml
Description	4K composition that presents white lines on a black background.
Conforms to	[SMPTE-429-7], [SMPTE-429-16]
Prerequisites	<i>4K SDR White Lines on Black Background, Silence, 5.1, 15 minutes</i>

A.4.185. DCI HDR Gray Steps

Type	CPL
Filename	hdr_gray_step.cpl.xml
Conforms to	SMPTE-429-7, SMPTE-429-16, [DCI-HDR]
Prerequisites	<i>HDR Black to Gray Step Series, Silence, 5.1, 15 minutes</i>

A.4.186. DCI HDR White Steps

Type	CPL
Filename	hdr_white_step.cpl.xml
Conforms to	SMPTE-429-7, SMPTE-429-16, [DCI-HDR]
Prerequisites	<i>HDR Black to White Step Series, Silence, 5.1, 15 minutes</i>

A.4.187. 2K Full HDR Black with Marks

Type	CPL
Filename	2k_full_hdr_black_marks_pt.cpl.xml
Description	2K full HDR black composition with registration marks. The MainPictureActiveArea item of the CPL is set to the dimensions of the encoded image.
Conforms to	[SMPTE-429-7], [SMPTE-429-16], [DCI-HDR]
Prerequisites	<i>2K Full HDR Black with Marks, Silence, 5.1, 15 minutes</i>

A.4.188. 2K Scope HDR Black with Marks

Type	CPL
-------------	-----

Filename	2k_scope_hdr_black_marks_pt.cpl.xml
Description	2K scope HDR black composition with registration marks. The MainPictureActiveArea item of the CPL is set to the dimensions of the encoded image.
Conforms to	[SMPTE-429-7], [SMPTE-429-16], [DCI-HDR]
Prerequisites	<i>2K Scope HDR Black with Marks, Silence, 5.1, 15 minutes</i>

A.4.189. 2K Flat HDR Black with Marks

Type	CPL
Filename	2k_flat_hdr_black_marks_pt.cpl.xml
Description	2K flat HDR black composition with registration marks. The MainPictureActiveArea item of the CPL is set to the dimensions of the encoded image.
Conforms to	[SMPTE-429-7], [SMPTE-429-16], [DCI-HDR]
Prerequisites	<i>2K Flat HDR Black with Marks, Silence, 5.1, 15 minutes</i>

A.4.190. 4K Full HDR Black with Marks

Type	CPL
Filename	4k_full_hdr_black_marks_pt.cpl.xml
Description	4K full HDR black composition with registration marks. The MainPictureActiveArea item of the CPL is set to the dimensions of the encoded image.
Conforms to	[SMPTE-429-7], [SMPTE-429-16], [DCI-HDR]
Prerequisites	<i>4K Full HDR Black with Marks, Silence, 5.1, 15 minutes</i>

A.4.191. 4K Scope HDR Black with Marks

Type	CPL
Filename	4k_scope_hdr_black_marks_pt.cpl.xml
Description	4K scope HDR black composition with registration marks. The MainPictureActiveArea item of the CPL is set to the dimensions of the encoded image.
Conforms to	[SMPTE-429-7], [SMPTE-429-16], [DCI-HDR]
Prerequisites	<i>4K Scope HDR Black with Marks, Silence, 5.1, 15 minutes</i>

A.4.192. 4K Flat HDR Black with Marks

Type	CPL
Filename	4k_flat_hdr_black_marks_pt.cpl.xml

Description	4K flat HDR black composition with registration marks. The MainPictureActiveArea item of the CPL is set to the dimensions of the encoded image.
Conforms to	[SMPTE-429-7], [SMPTE-429-16], [DCI-HDR]
Prerequisites	<i>4K Flat HDR Black with Marks, Silence, 5.1, 15 minutes</i>

A.4.193. 2K Full HDR Black with Active Area

Type	CPL
Filename	2k_full_hdr_black_active_pt.cpl.xml
Description	2K full HDR composition with an active area indicated by registration marks and specified by the MainPictureActiveArea item of the CPL.
Conforms to	[SMPTE-429-7], [SMPTE-429-16], [DCI-HDR]
Prerequisites	<i>2K Full HDR Black with Active Area, Silence, 5.1, 15 minutes</i>

A.4.194. 2K Scope HDR Black with Active Area

Type	CPL
Filename	2k_scope_hdr_black_active_pt.cpl.xml
Description	2K scope HDR composition with an active area indicated by registration marks and specified by the MainPictureActiveArea item of the CPL.
Conforms to	[SMPTE-429-7], [SMPTE-429-16], [DCI-HDR]
Prerequisites	<i>2K Scope HDR Black with Active Area, Silence, 5.1, 15 minutes</i>

A.4.195. 2K Flat HDR Black with Active Area

Type	CPL
Filename	2k_flat_hdr_black_active_pt.cpl.xml
Description	2K flat HDR with an active area indicated by registration marks and specified by the MainPictureActiveArea item of the CPL.
Conforms to	[SMPTE-429-7], [SMPTE-429-16], [DCI-HDR]
Prerequisites	<i>2K Flat HDR Black with Active Area, Silence, 5.1, 15 minutes</i>

A.4.196. 4K Full HDR Black with Active Area

Type	CPL
Filename	4k_full_hdr_black_active_pt.cpl.xml
Description	4K full HDR with an active area indicated by registration marks and specified by the MainPictureActiveArea item of the CPL.

Conforms to	[SMPTE-429-7], [SMPTE-429-16], [DCI-HDR]
Prerequisites	<i>4K Full HDR Black with Active Area, Silence, 5.1, 15 minutes</i>

A.4.197. 4K Scope HDR Black with Active Area

Type	CPL
Filename	4k_scope_hdr_black_active_pt.cpl.xml
Description	4K scope HDR with an active area indicated by registration marks and specified by the MainPictureActiveArea item of the CPL.
Conforms to	[SMPTE-429-7], [SMPTE-429-16], [DCI-HDR]
Prerequisites	<i>4K Scope HDR Black with Active Area, Silence, 5.1, 15 minutes</i>

A.4.198. 4K Flat HDR Black with Active Area

Type	CPL
Filename	4k_flat_hdr_black_active_pt.cpl.xml
Description	4K flat HDR with an active area indicated by registration marks and specified by the MainPictureActiveArea item of the CPL.
Conforms to	[SMPTE-429-7], [SMPTE-429-16], [DCI-HDR]
Prerequisites	<i>4K Flat HDR Black with Active Area, Silence, 5.1, 15 minutes</i>

A.4.199. SDR Detection

Type	CPL
Filename	sdr_detection.cpl.xml
Description	SDR composition intended to verify that the system is configured to playback SDR presentations.
Conforms to	SMPTE-429-7, SMPTE-429-16
Prerequisites	<i>SDR verification pattern, Silence, 5.1, 15 minutes</i>

A.4.200. HDR Detection

Type	CPL
Filename	hdr_detection.cpl.xml
Description	HDR composition intended to verify that the system is configured to playback HDR presentations.
Conforms to	SMPTE-429-7, SMPTE-429-16, [DCI-HDR]
Prerequisites	<i>HDR verification pattern, Silence, 5.1, 15 minutes</i>

A.4.201. 2K 2D 24 FPS Test

Type	CPL
Filename	2k_2d_24_fps_pt.cpl.xml
Description	2K 2D composition at 24 fps intended to verify that an imaging device displays all images.
Conforms to	[SMPTE-429-7], [SMPTE-429-16]
Prerequisites	<i>2K 2D 24 FPS Test, 24 FPS test, 24 FPS test timecode</i>

A.4.202. 2K 2D 48 FPS Test

Type	CPL
Filename	2k_2d_48_fps_pt.cpl.xml
Description	2K 2D composition at 48 fps intended to verify that an imaging device displays all images.
Conforms to	[SMPTE-429-7], [SMPTE-429-16]
Prerequisites	<i>2K 2D 48 FPS Test, 48 FPS test, 48 FPS test timecode</i>

A.4.203. 2K 2D 60 FPS Test

Type	CPL
Filename	2k_2d_60_fps_pt.cpl.xml
Description	2K 2D composition at 60 fps intended to verify that an imaging device displays all images.
Conforms to	[SMPTE-429-7], [SMPTE-429-16]
Prerequisites	<i>2K 2D 60 FPS Test, 60 FPS test, 60 FPS test timecode</i>

A.4.204. 2K 2D 96 FPS Test

Type	CPL
Filename	2k_2d_96_fps_pt.cpl.xml
Description	2K 2D composition at 96 fps intended to verify that an imaging device displays all images.
Conforms to	[SMPTE-429-7], [SMPTE-429-16]
Prerequisites	<i>2K 2D 96 FPS Test, 96 FPS test, 96 FPS test timecode</i>

A.4.205. 2K 2D 120 FPS Test

Type	CPL
Filename	2k_2d_120_fps_pt.cpl.xml

Description	2K 2D composition at 120 fps intended to verify that an imaging device displays all images.
Conforms to	[SMPTE-429-7], [SMPTE-429-16]
Prerequisites	<i>2K 2D 120 FPS Test, 120 FPS test, 120 FPS test timecode</i>

A.4.206. 2K Stereoscopic 24 FPS Test

Type	CPL
Filename	2k_stereo_24_fps_pt.cpl.xml
Description	2K stereoscopic composition at 24 fps intended to verify that an imaging device displays all images.
Conforms to	[SMPTE-429-7], [SMPTE-429-16], [SMPTE-429-10]
Prerequisites	<i>2K Stereoscopic 24 FPS Test, 24 FPS test, 24 FPS test timecode</i>

A.4.207. 2K Stereoscopic 48 FPS Test

Type	CPL
Filename	2k_stereo_48_fps_pt.cpl.xml
Description	2K stereoscopic composition at 48 fps intended to verify that an imaging device displays all images.
Conforms to	[SMPTE-429-7], [SMPTE-429-16]
Prerequisites	<i>2K Stereoscopic 48 FPS Test, 48 FPS test, 48 FPS test timecode</i>

A.4.208. 2K Stereoscopic 60 FPS Test

Type	CPL
Filename	2k_stereo_60_fps_pt.cpl.xml
Description	2K stereoscopic composition at 60 fps intended to verify that an imaging device displays all images.
Conforms to	[SMPTE-429-7], [SMPTE-429-16]
Prerequisites	<i>2K Stereoscopic 60 FPS Test, 60 FPS test, 60 FPS test timecode</i>

A.4.209. 4K 2D 24 FPS Test

Type	CPL
Filename	4k_2d_24_fps_pt.cpl.xml
Description	4K 2D composition at 24 fps intended to verify that an imaging device displays all images.
Conforms to	[SMPTE-429-7], [SMPTE-429-16]
Prerequisites	<i>4K 2D 24 FPS Test, 24 FPS test, 24 FPS test timecode</i>

A.4.210. 4K 2D 48 FPS Test

Type	CPL
Filename	4k_2d_48_fps_pt.cpl.xml
Description	4K 2D composition at 48 fps intended to verify that an imaging device displays all images.
Conforms to	[SMPTE-429-7], [SMPTE-429-16]
Prerequisites	4K 2D 48 FPS Test, 48 FPS test, 48 FPS test timecode

A.4.211. 4K 2D 60 FPS Test

Type	CPL
Filename	4k_2d_60_fps_pt.cpl.xml
Description	4K 2D composition at 60 fps intended to verify that an imaging device displays all images.
Conforms to	[SMPTE-429-7], [SMPTE-429-16]
Prerequisites	4K 2D 60 FPS Test, 60 FPS test, 60 FPS test timecode

A.4.212. SDR Dark Gray Scale

Type	CPL
Filename	sdr_dark_gray_pt.cpl.xml
Conforms to	[SMPTE-429-7], [SMPTE-429-16]
Prerequisites	SDR Dark Gray Scale, Silence, 5.1, 15 minutes

A.4.213. HDR Dark Gray Scale

Type	CPL
Filename	hdr_dark_gray_pt.cpl.xml
Conforms to	[SMPTE-429-7], [SMPTE-429-16], [DCI-HDR]
Prerequisites	HDR Dark Gray Scale, Silence, 5.1, 15 minutes

A.5. Digital Certificates

Six certificate chains are defined, which separate certificates by device type and level of conformity. In the descriptions below, the IMB label refers to a certificate which contains roles for a Media Block (MB) or a certificate which signs such certificates. Similarly, PRJ refers to certificates or signers associated with an Imaging Device and KDS refers to certificates associated with a Key Distribution System (a KDM authoring entity).

- Chain A1 contains valid IMB certificates.
- Chain A2 contains valid IMB certificates but the chain has no intermediate signers.

- Chain A3 contains invalid IMB certificates.
- Chain B1 contains valid PRJ certificates.
- Chain C1 contains valid KDS certificates.
- Chain C3 contains invalid KDS certificates.

A.5.1. Chain A1 IMB Certificate Files

Contents removed, not used by any procedure

A.5.2. Chain A2 IMB Certificate Files

Contents removed, not used by any procedure

A.5.3. Chain A3 IMB Certificate Files

A.5.3.1. chain-a3-root

Type	IMB Certificate
Filename	IMB-chain-a3-root.pem
Description	Root cert, malformed leaves
Conforms to	SMPTE-430-2
Prerequisites	<i>chain-a3-root-key</i>

A.5.3.2. chain-a3-signer1

Type	IMB Certificate
Filename	IMB-chain-a3-osig-type.pem
Description	Intermediate Signer, level one
Conforms to	SMPTE-430-2
Prerequisites	<i>chain-a3-root, chain-a3-signer1-key</i>

A.5.3.3. chain-a3-osig-type

Type	IMB Certificate
Filename	IMB-chain-a3-osig-type.pem
Description	Signature algorithm of outside signature not sha256WithRSAEncryption
Conforms to	SMPTE-430-2
Prerequisites	<i>chain-a3-signer1, chain-a3-leaf-key</i>
Malformations	Signature algorithm of outside signature is sha1WithRSAEncryption

A.5.3.4. chain-a3-isig-type

Type	IMB Certificate
Filename	IMB-chain-a3-isig-type.pem
Description	Signature algorithm inside signature not sha256WithRSAEncryption
Conforms to	SMPTE-430-2
Prerequisites	<i>chain-a3-signer1, chain-a3-leaf-key</i>
Malformations	Signature algorithm inside the signature is sha1WithRSAEncryption

A.5.3.5. chain-a3-iosig-type

Type	IMB Certificate
Filename	IMB-chain-a3-iosig-type.pem
Description	Signature algorithm inside and outside identical, but not sha256WithRSAEncryption
Conforms to	SMPTE-430-2
Prerequisites	<i>chain-a3-signer1, chain-a3-leaf-key</i>
Malformations	Signature algorithm is sha1WithRSAEncryption

A.5.3.6. chain-a3-no-rsa

Type	IMB Certificate
Filename	IMB-chain-a3-short-rsa.pem
Description	Public Key not an RSA Key
Conforms to	SMPTE-430-2
Prerequisites	<i>chain-a3-signer1, chain-a3-no-rsa-key</i>
Malformations	Public Key is a DSA key.

A.5.3.7. chain-a3-short-rsa

Type	IMB Certificate
Filename	IMB-chain-a3-short-rsa.pem
Description	Public Key Length 1024 bit
Conforms to	SMPTE-430-2
Prerequisites	<i>chain-a3-signer1, chain-a3-short-rsa-key</i>
Malformations	Public key is 1024 bits.

A.5.3.8. chain-a3-bad-exp

Type	IMB Certificate
Filename	IMB-chain-a3-bad-exp.pem
Description	Public Key Exponent other than the required 65537
Conforms to	SMPTE-430-2
Prerequisites	<i>chain-a3-signer1, chain-a3-bad-exp-key</i>
Malformations	Public Key Exponent is 3.

A.5.3.9. IMB-chain-a3-BER-enc

Type	IMB Certificate
Filename	IMB-chain-a3-BER-enc.pem
Description	Encoded as BER (not DER)
Conforms to	SMPTE-430-2
Prerequisites	<i>chain-a3-signer1, chain-a3-leaf-key</i>
Malformations	Certificate uses BER encoding.

A.5.3.10. chain-a3-no-saf

Type	IMB Certificate
Filename	IMB-chain-a3-no-saf.pem
Description	Missing SignatureAlgorithm field
Conforms to	SMPTE-430-2
Prerequisites	<i>chain-a3-signer1, chain-a3-leaf-key</i>
Malformations	SignatureAlgorithm field is not present

A.5.3.11. chain-a3-no-svf

Type	IMB Certificate
Filename	IMB-chain-a3-no-svf.pem
Description	Missing SignatureValue field
Conforms to	SMPTE-430-2
Prerequisites	<i>chain-a3-signer1, chain-a3-leaf-key</i>
Malformations	Missing SignatureValue field

A.5.3.12. chain-a3-no-ver

Type	IMB Certificate
Filename	IMB-chain-a3-no-ver.pem
Description	Missing Version field
Conforms to	SMPTE-430-2
Prerequisites	<i>chain-a3-signer1, chain-a3-leaf-key</i>
Malformations	Missing Version field

A.5.3.13. chain-a3-no-sn

Type	IMB Certificate
Filename	IMB-chain-a3-no-sn.pem
Description	Missing SerialNumber field
Conforms to	SMPTE-430-2
Prerequisites	<i>chain-a3-signer1, chain-a3-leaf-key</i>
Malformations	Missing SerialNumber field

A.5.3.14. chain-a3-no-sig

Type	IMB Certificate
Filename	IMB-chain-a3-no-sig.pem
Description	Missing Signature field
Conforms to	SMPTE-430-2
Prerequisites	<i>chain-a3-signer1, chain-a3-leaf-key, chain-a3-signer1, chain-a3-leaf-key</i>
Malformations	Missing Signature field

A.5.3.15. chain-a3-no-issuer

Type	IMB Certificate
Filename	IMB-chain-a3-no-issuer.pem
Description	Missing Issuer field
Conforms to	SMPTE-430-2
Prerequisites	<i>chain-a3-signer1, chain-a3-leaf-key</i>
Malformations	The Issuer field is not present.

A.5.3.16. chain-a3-no-subject

Type	IMB Certificate
Filename	IMB-chain-a3-no-subject.pem
Description	Missing Subject field
Conforms to	SMPTE-430-2
Prerequisites	<i>chain-a3-signer1, chain-a3-leaf-key</i>
Malformations	Missing Subject field

A.5.3.17. chain-a3-no-spki

Type	IMB Certificate
Filename	IMB-chain-a3-no-spki.pem
Description	Missing SubjectPublicKeyInfo field
Conforms to	SMPTE-430-2
Prerequisites	<i>chain-a3-signer1, chain-a3-leaf-key</i>
Malformations	Missing SubjectPublicKeyInfo field

A.5.3.18. chain-a3-no-val-f

Type	IMB Certificate
Filename	IMB-chain-a3-no-aki-f.pem
Description	Missing Validity field
Conforms to	SMPTE-430-2
Prerequisites	<i>chain-a3-signer1, chain-a3-leaf-key</i>
Malformations	Missing Validity field

A.5.3.19. chain-a3-no-aki-f

Type	IMB Certificate
Filename	IMB-chain-a3-no-aki-f.pem
Description	Missing AuthorityKeyIdentifier field
Conforms to	SMPTE-430-2
Prerequisites	<i>chain-a3-signer1, chain-a3-leaf-key</i>
Malformations	The AuthorityKeyIdentifier is not present.

A.5.3.20. chain-a3-no-keyuse

Type	IMB Certificate
Filename	IMB-chain-a3-no-keyuse.pem
Description	Missing KeyUsage field
Conforms to	SMPTE-430-2
Prerequisites	<i>chain-a3-signer1, chain-a3-leaf-key</i>
Malformations	The Key Usage field is not present.

A.5.3.21. chain-a3-no-basic

Type	IMB Certificate
Filename	IMB-chain-a3-no-basic.pem
Description	Missing BasicConstraint field
Conforms to	SMPTE-430-2
Prerequisites	<i>chain-a3-signer1, chain-a3-leaf-key</i>
Malformations	The Basic Constraints field is not present.

A.5.3.22. chain-a3-path-1

Type	IMB Certificate
Filename	IMB-chain-a3-path-1.pem
Description	Cert.Auth. true, PathLen present and positive
Conforms to	SMPTE-430-2
Prerequisites	<i>chain-a3-signer1, chain-a3-leaf-key</i>

A.5.3.23. chain-a3-path-2

Type	IMB Certificate
Filename	IMB-chain-a3-path-2.pem
Description	Cert.Auth. true, PathLen present and positive
Conforms to	SMPTE-430-2
Prerequisites	<i>chain-a3-signer1, chain-a3-leaf-key</i>

A.5.3.24. chain-a3-path-3

Type	IMB Certificate
-------------	-----------------

Filename	IMB-chain-a3-path-3.pem
Description	Cert.Auth. true, PathLen present and negative
Conforms to	SMPTE-430-2
Prerequisites	<i>chain-a3-signer1, chain-a3-leaf-key</i>
Malformations	PathLen is -1.

A.5.3.25. chain-a3-path-4

Type	IMB Certificate
Filename	IMB-chain-a3-path-4.pem
Description	Cert.Auth. false, PathLen absent
Conforms to	SMPTE-430-2
Prerequisites	<i>chain-a3-signer1, chain-a3-leaf-key</i>

A.5.3.26. chain-a3-path-5

Type	IMB Certificate
Filename	IMB-chain-a3-path-6.pem
Description	Cert.Auth. false, PathLen positive
Conforms to	SMPTE-430-2
Prerequisites	<i>chain-a3-signer1, chain-a3-leaf-key</i>

A.5.3.27. chain-a3-path-6

Type	IMB Certificate
Filename	IMB-chain-a3-path-6.pem
Description	Cert.Auth. false, PathLen positive
Conforms to	SMPTE-430-2
Prerequisites	<i>chain-a3-signer1, chain-a3-leaf-key</i>

A.5.3.28. chain-a3-path-7

Type	IMB Certificate
Filename	IMB-chain-a3-path-7.pem
Description	Cert.Auth. false, PathLen negative
Conforms to	SMPTE-430-2

Prerequisites	<i>chain-a3-signer1, chain-a3-leaf-key</i>
----------------------	--

A.5.3.29. chain-a3-org-name

Type	IMB Certificate
Filename	IMB-chain-a3-org-name.pem
Description	OrganizationName in subject and issuer fields does not match
Conforms to	SMPTE-430-2
Prerequisites	<i>chain-a3-signer1, chain-a3-leaf-key</i>
Malformations	OrganizationName in subject field has first two letters transposed.

A.5.3.30. chain-a3-role-1

Type	IMB Certificate
Filename	IMB-chain-a3-role-2.pem
Description	Cert.Auth. False, no role specified in CommonName
Conforms to	SMPTE-430-2
Prerequisites	<i>chain-a3-signer1, chain-a3-leaf-key</i>
Malformations	Common Name begins with a period (".")

A.5.3.31. chain-a3-role-2

Type	IMB Certificate
Filename	IMB-chain-a3-role-2.pem
Description	Non-SMS role in CN
Conforms to	SMPTE-430-2
Prerequisites	<i>chain-a3-signer1, chain-a3-leaf-key</i>
Malformations	Common Name does not include SMS in the section to the left of the first period (".").

A.5.3.32. chain-a3-date-exp

Type	IMB Certificate
Filename	IMB-chain-a3-date-exp.pem
Description	Expired
Conforms to	SMPTE-430-2
Prerequisites	<i>chain-a3-signer1, chain-a3-leaf-key</i>

Malformations Certificate Not After field contains a date value in the past.

A.5.4. Chain B1 Certificate Files

A.5.4.1. chain-b1-root

Type	PRJ Certificate
Filename	PRJ-chain-b1-root.pem
Description	Self-signed root certificate for PRJ devices
Conforms to	SMPTE-430-2
Prerequisites	<i>chain-b1-root-key</i>

A.5.5. Chain C1 Certificate Files

A.5.5.1. chain-c1-root

Type	KDS Certificate
Filename	KDS-chain-c1-root.pem
Description	Self-signed root certificate for KDS devices
Conforms to	SMPTE-430-2
Prerequisites	<i>chain-c1-root-key</i>

A.5.6. Chain C3 Certificate Files

A.5.6.1. chain-c3-root

Type	KDS Certificate
Filename	KDS-chain-c3-root.pem
Description	Self-signed root certificate for KDS devices
Conforms to	SMPTE-430-2
Prerequisites	<i>chain-c3-root-key</i>

A.5.6.2. chain-c3-signer1

Type	IMB Certificate
Filename	KDS-chain-c3-signer1.pem
Description	Intermediate Signer, level one
Conforms to	SMPTE-430-2
Prerequisites	<i>chain-c3-root, chain-c3-signer1-key</i>

A.5.6.3. chain-c3-osig-type

Type	KDS Certificate
Filename	KDS-chain-c3-osig-type.pem
Description	Signature algorithm of outside signature is sha1WithRSAEncryption
Conforms to	SMPTE-430-2
Prerequisites	<i>chain-c3-signer1, chain-c3-leaf-key</i>

A.5.6.4. chain-c3-isig-type

Type	KDS Certificate
Filename	KDS-chain-c3-isig-type.pem
Description	Signature algorithm inside signature not sha256WithRSAEncryption
Conforms to	SMPTE-430-2
Prerequisites	<i>chain-c3-signer1, chain-c3-leaf-key</i>
Malformations	Signature algorithm inside the signature is sha1WithRSAEncryption

A.5.6.5. chain-c3-iosig-type

Type	KDS Certificate
Filename	KDS-chain-c3-iosig-type.pem
Description	Signature algorithm inside and outside identical, but not sha256WithRSAEncryption
Conforms to	SMPTE-430-2
Prerequisites	<i>chain-c3-signer1, chain-c3-leaf-key</i>
Malformations	Signature algorithm is sha1WithRSAEncryption

A.5.6.6. chain-c3-no-rsa

Type	KDS Certificate
Filename	KDS-chain-c3-short-rsa.pem
Description	Public Key not an RSA Key
Conforms to	SMPTE-430-2
Prerequisites	<i>chain-c3-signer1, chain-c3-no-rsa-key</i>
Malformations	Public key is DSA key

A.5.6.7. chain-c3-short-rsa

Type	KDS Certificate
Filename	KDS-chain-c3-short-rsa.pem
Description	Public Key Length 1024 bit
Conforms to	SMPTE-430-2
Prerequisites	<i>chain-c3-signer1, chain-c3-short-rsa-key</i>
Malformations	Public key is 1024 bits.

A.5.6.8. chain-c3-bad-exp

Type	KDS Certificate
Filename	KDS-chain-c3-bad-exp.pem
Description	Public Key Exponent other than default 65537
Conforms to	SMPTE-430-2
Prerequisites	<i>chain-c3-signer1, chain-c3-bad-exp-key</i>
Malformations	Public Key Exponent is 3.

A.5.6.9. chain-c3-BER-enc

Type	KDS Certificate
Filename	KDS-chain-c3-BER-enc.pem
Description	Encoded as BER (not DER)
Conforms to	SMPTE-430-2
Prerequisites	<i>chain-c3-signer1, chain-c3-leaf-key</i>
Malformations	Certificate uses BER encoding.

A.5.6.10. chain-c3-no-saf

Type	KDS Certificate
Filename	KDS-chain-c3-no-svf.pem
Description	Missing SignatureAlgorithm field
Conforms to	SMPTE-430-2
Prerequisites	<i>chain-c3-signer1, chain-c3-leaf-key</i>
Malformations	SignatureAlgorithm field is not present

A.5.6.11. chain-c3-no-svf

Type	KDS Certificate
Filename	KDS-chain-c3-no-svf.pem
Description	Missing SignatureValue field
Conforms to	SMPTE-430-2
Prerequisites	<i>chain-c3-signer1, chain-c3-leaf-key</i>
Malformations	Missing SignatureValue field

A.5.6.12. chain-c3-no-ver

Type	KDS Certificate
Filename	KDS-chain-c3-no-ver.pem
Description	Missing Version field
Conforms to	SMPTE-430-2
Prerequisites	<i>chain-c3-signer1, chain-c3-leaf-key</i>
Malformations	Missing Version field

A.5.6.13. chain-c3-no-sn

Type	KDS Certificate
Filename	KDS-chain-c3-no-sn.pem
Description	Missing SerialNumber field
Conforms to	SMPTE-430-2
Prerequisites	<i>chain-c3-signer1, chain-c3-leaf-key</i>
Malformations	Missing SerialNumber field

A.5.6.14. chain-c3-no-sig

Type	KDS Certificate
Filename	KDS-chain-c3-no-sig.pem
Description	Missing Signature field
Conforms to	SMPTE-430-2
Prerequisites	<i>chain-c3-signer1, chain-c3-leaf-key</i>
Malformations	Missing Signature field

A.5.6.15. chain-c3-no-issuer

Type	KDS Certificate
Filename	KDS-chain-c3-no-issuer.pem
Description	Missing Issuer field
Conforms to	SMPTE-430-2
Prerequisites	<i>chain-c3-signer1, chain-c3-leaf-key</i>
Malformations	The Issuer field is not present.

A.5.6.16. chain-c3-no-subject

Type	KDS Certificate
Filename	KDS-chain-c3-no-subject.pem
Description	Missing Subject field
Conforms to	SMPTE-430-2
Prerequisites	<i>chain-c3-signer1, chain-c3-leaf-key</i>
Malformations	Missing Subject field

A.5.6.17. chain-c3-no-spki

Type	KDS Certificate
Filename	KDS-chain-c3-no-spki.pem
Description	Missing SubjectPublicKeyInfo field
Conforms to	SMPTE-430-2
Prerequisites	<i>chain-c3-signer1, chain-c3-leaf-key</i>
Malformations	Missing SubjectPublicKeyInfo field

A.5.6.18. chain-c3-no-val-f

Type	KDS Certificate
Filename	KDS-chain-c3-no-val-f.pem
Description	Missing Validity field
Conforms to	SMPTE-430-2
Prerequisites	<i>chain-c3-signer1, chain-c3-leaf-key</i>
Malformations	Missing Validity field

A.5.6.19. chain-c3-no-aki-f

Type	KDS Certificate
Filename	KDS-chain-c3-no-aki-f.pem
Description	Missing AuthorityKeyIdentifier field
Conforms to	SMPTE-430-2
Prerequisites	<i>chain-c3-signer1, chain-c3-leaf-key</i>
Malformations	The AuthorityKeyIdentifier is not present.

A.5.6.20. chain-c3-no-keyuse

Type	KDS Certificate
Filename	KDS-chain-c3-no-keyuse.pem
Description	Missing KeyUsage field
Conforms to	SMPTE-430-2
Prerequisites	<i>chain-c3-signer1, chain-c3-leaf-key</i>
Malformations	The Key Usage field is not present.

A.5.6.21. chain-c3-no-basic

Type	KDS Certificate
Filename	KDS-chain-c3-no-basic.pem
Description	Missing BasicConstraint field
Conforms to	SMPTE-430-2
Prerequisites	<i>chain-c3-signer1, chain-c3-leaf-key</i>
Malformations	The Basic Constraints field is not present.

A.5.6.22. chain-c3-path-1

Type	KDS Certificate
Filename	KDS-chain-c3-path-1.pem
Description	Cert.Auth. true, PathLenpresent and zero
Conforms to	SMPTE-430-2
Prerequisites	<i>chain-c3-signer1, chain-c3-leaf-key</i>

A.5.6.23. chain-c3-path-2

Type	KDS Certificate
-------------	-----------------

Filename	KDS-chain-c3-path-2.pem
Description	Cert.Auth. true, PathLen present and positive
Conforms to	SMPTE-430-2
Prerequisites	<i>chain-c3-signer1, chain-c3-leaf-key</i>

A.5.6.24. chain-c3-path-3

Type	KDS Certificate
Filename	KDS-chain-c3-path-3.pem
Description	Cert.Auth. true, PathLen present and negative
Conforms to	SMPTE-430-2
Prerequisites	<i>chain-c3-signer1, chain-c3-leaf-key</i>
Malformations	PathLen is -1.

A.5.6.25. chain-c3-path-4

Type	KDS Certificate
Filename	KDS-chain-c3-path-4.pem
Description	Cert.Auth. false, PathLen absent
Conforms to	SMPTE-430-2
Prerequisites	<i>chain-c3-signer1, chain-c3-leaf-key</i>

A.5.6.26. chain-c3-path-5

Type	KDS Certificate
Filename	KDS-chain-c3-path-5.pem
Description	Cert.Auth. false, PathLen zero
Conforms to	SMPTE-430-2
Prerequisites	<i>chain-c3-signer1, chain-c3-leaf-key</i>

A.5.6.27. chain-c3-path-6

Type	KDS Certificate
Filename	KDS-chain-c3-path-6.pem
Description	Cert.Auth. false, PathLen positive
Conforms to	SMPTE-430-2

Prerequisites	<i>chain-c3-signer1, chain-c3-leaf-key</i>
----------------------	--

A.5.6.28. chain-c3-path-7

Type	KDS Certificate
Filename	KDS-chain-c3-path-7.pem
Description	Cert.Auth. false, PathLen negative
Conforms to	SMPTE-430-2
Prerequisites	<i>chain-c3-signer1, chain-c3-leaf-key</i>

A.5.6.29. chain-c3-org-name

Type	KDS Certificate
Filename	KDS-chain-c3-org-name.pem
Description	OrganizationName in subject and issuer fields does not match
Conforms to	SMPTE-430-2
Prerequisites	<i>chain-c3-signer1, chain-c3-leaf-key</i>
Malformations	OrganizationName in subject field has first two letters transposed.

A.5.6.30. chain-c3-role-1

Type	KDS Certificate
Filename	KDS-chain-c3-role-1.pem
Description	Cert.Auth. False, no role specified in CommonName
Conforms to	SMPTE-430-2
Prerequisites	<i>chain-c3-signer1, chain-c3-leaf-key</i>
Malformations	Common Name begins with a period (".")

A.5.6.31. chain-c3-date-exp

Type	KDS Certificate
Filename	KDS-chain-c3-date-exp.pem
Description	Expired
Conforms to	SMPTE-430-2
Prerequisites	<i>chain-c3-signer1, chain-c3-leaf-key</i>
Malformations	Certificate Not After field contains a date value in the past.

A.5.6.32. chain-c3-role-2

Type	KDS Certificate
Filename	KDS-chain-c3-role-2.pem
Description	Cert.Auth. False, role error (CN contains only FMI).
Conforms to	SMPTE-430-2
Prerequisites	<i>chain-c3-signer1, chain-c3-leaf-key</i>

A.5.7. Public/Private Key Pairs

A.5.7.1. chain-a3-bad-exp-key

Type	RSA keypair
Filename	IMB-chain-a3-bad-exp-key.pem
Description	RSA keypair for Public Key Exponent other than the required 65537
Conforms to	SMPTE-430-2
Malformations	Public Key Exponent is 3.

A.5.7.2. chain-a3-leaf-key

Type	RSA keypair
Filename	IMB-chain-a3-leaf-key.pem
Description	RSA keypair for leaf
Conforms to	SMPTE-430-2

A.5.7.3. chain-a3-no-rsa-key

Type	DSA keypair
Filename	IMB-chain-a3-no-rsa-key.pem
Description	DSA keypair for Public Key not an RSA Key
Conforms to	SMPTE-430-2
Malformations	Public Key is a DSA key.

A.5.7.4. chain-a3-root-key

Type	RSA keypair
Filename	IMB-chain-a3-root-key.pem
Description	RSA keypair for root cert, malformed leaves

Conforms to	SMPTE-430-2
--------------------	-------------

A.5.7.5. chain-a3-short-rsa-key

Type	RSA keypair
Filename	IMB-chain-a3-short-rsa-key.pem
Description	RSA keypair for Public Key Length 1024 bit
Conforms to	SMPTE-430-2
Malformations	Public key is 1024 bits.

A.5.7.6. chain-a3-signer1-key

Type	RSA keypair
Filename	IMB-chain-a3-signer1-key.pem
Description	RSA keypair for Intermediate Signer, level one
Conforms to	SMPTE-430-2

A.5.7.7. chain-c1-root-key

Type	RSA keypair
Filename	KDS-chain-c1-root-key.pem
Description	RSA keypair for self-signed root certificate for KDS devices
Conforms to	SMPTE-430-2

A.5.7.8. chain-c3-bad-exp-key

Type	RSA keypair
Filename	KDS-chain-c3-bad-exp-key.pem
Description	RSA keypair for Public Key Exponent other than default 65537
Conforms to	SMPTE-430-2
Malformations	Public Key Exponent is 3.

A.5.7.9. chain-c3-leaf-key

Type	RSA keypair
Filename	KDS-chain-c3-leaf-key.pem
Description	RSA keypair for leaf
Conforms to	SMPTE-430-2

A.5.7.10. chain-c3-no-rsa-key

Type	DSA keypair
Filename	KDS-chain-c3-no-rsa-key.pem
Description	DSA keypair for Public Key not an RSA Key
Conforms to	SMPTE-430-2
Malformations	Public Key is a DSA key.

A.5.7.11. chain-c3-root-key

Type	RSA keypair
Filename	KDS-chain-c3-root-key.pem
Description	RSA keypair for self-signed root certificate for KDS devices
Conforms to	SMPTE-430-2

A.5.7.12. chain-c3-short-rsa-key

Type	RSA keypair
Filename	KDS-chain-c3-short-rsa-key.pem
Description	RSA keypair for Public Key Length 1024 bit
Conforms to	SMPTE-430-2
Malformations	Public key is 1024 bits.

A.5.7.13. chain-c3-signer1-key

Type	RSA keypair
Filename	KDS-chain-c3-signer1-key.pem
Description	RSA keypair for Intermediate Signer, level one
Conforms to	SMPTE-430-2

A.5.7.14. chain-b1-root-key

Type	RSA keypair
Filename	PRJ-chain-b1-root-key.pem
Description	RSA keypair for self-signed root certificate for PRJ devices
Conforms to	SMPTE-430-2

A.6. Key Delivery Messages

A.6.1. Introduction

The KDM files defined in this section must be generated for the Test Subject and the time and date of the test procedure.

A.6.2. KDM for DCI 2K Sync Test (Encrypted)

Type	KDM
Filename	2K_sync_test_ct.kdm.xml
Conforms to	SMPTE-430-1, SMPTE-430-3
Prerequisites	<i>DCI 2K Sync Test (Encrypted)</i>

A.6.3. KDM for DCI 2K Sync Test with Subtitles (Encrypted)

Type	KDM
Filename	sync_test_with_subs_ct.kdm.xml
Conforms to	SMPTE-430-1, SMPTE-430-3
Prerequisites	<i>DCI 2K Sync test with Subtitles (Encrypted)</i>

A.6.4. KDM for DCI 2K Image with Frame Number Burn In (Encrypted)

Type	KDM
Filename	frame_num_burn_in_ct.kdm.xml
Conforms to	SMPTE-430-1, SMPTE-430-3
Prerequisites	<i>DCI 2K Image with Frame Number Burn In (Encrypted)</i>

A.6.5. KDM for 2K StEM (Encrypted)

Type	KDM
Filename	2K_StEM_ct.kdm.xml
Conforms to	SMPTE-430-1, SMPTE-430-3
Prerequisites	<i>DCI 2K StEM (Encrypted)</i>

A.6.6. KDM for 2K StEM Sequence (Encrypted)

Type	KDM
Filename	2K_StEM_sequence_ct.kdm.xml
Conforms to	SMPTE-430-1, SMPTE-430-3
Prerequisites	<i>DCI 2K StEM Test Sequence (Encrypted)</i>

A.6.7. KDM for 128 Reel Composition, "A" Series (Encrypted)

Type	KDM
Filename	2K_StEM_128_a_reels_ct.kdm.xml
Description	KDM that has all content keys for the track files referenced by the CPL, and additionally has one each of key types FMIK and FMAK. The FMIK and FMAK key values shall be appropriate for the specifications of the FM system used by the Test Subject.
Conforms to	SMPTE-430-1, SMPTE-430-3
Prerequisites	<i>128 Reel Composition, "A" Series (Encrypted)</i>

A.6.8. KDM for 128 Reel Composition, "B" Series (Encrypted)

Type	KDM
Filename	2K_StEM_128_b_reels_ct.kdm.xml
Description	KDM that has all content keys for the track files referenced by the CPL, and additionally has one each of key types FMIK and FMAK. The FMIK and FMAK key values shall be appropriate for the specifications of the FM system used by the Test Subject.
Conforms to	SMPTE-430-1, SMPTE-430-3
Prerequisites	<i>128 Reel Composition, "B" Series (Encrypted)</i>

A.6.9. KDM for 64 1 second reel Composition (Encrypted)

Type	KDM
Filename	2K_StEM_64_1_second_reels_ct.kdm.xml
Conforms to	SMPTE-430-1, SMPTE-430-3
Prerequisites	<i>64 Reel Composition, 1 Second Reels (Encrypted)</i>

A.6.10. KDM for 2K FM Application Constraints (Encrypted)

Type	KDM
Filename	2K_fm_constraints_ct.kdm.xml
Conforms to	SMPTE-430-1, SMPTE-430-3
Prerequisites	<i>2K FM Application Constraints (Encrypted)</i>

A.6.11. KDM for 2K FM Control Granularity - No FM (Encrypted)

Type	KDM
Filename	2K_fm_control_granularity_no_fm.kdm.xml

Conforms to	SMPTE-430-1, SMPTE-430-3
Prerequisites	<i>2K FM Control Granularity - No FM (Encrypted)</i>

A.6.12. KDM for 2K FM Control Granularity - Image Only FM (Encrypted)

Type	KDM
Filename	2K_fm_control_granularity_image_only_fm.kdm.xml
Conforms to	SMPTE-430-1, SMPTE-430-3
Prerequisites	<i>2K FM Control Granularity - Image Only FM (Encrypted)</i>

A.6.13. KDM for 2K FM Control Granularity - Sound Only FM (Encrypted)

Type	KDM
Filename	2K_fm_control_granularity_sound_only_fm.kdm.xml
Conforms to	SMPTE-430-1, SMPTE-430-3
Prerequisites	<i>2K FM Control Granularity - Sound Only FM (Encrypted)</i>

A.6.14. KDM for 2K FM Control Granularity - Image and Sound FM (Encrypted)

Type	KDM
Filename	2K_fm_control_granularity_image_and_sound_fm.kdm.xml
Conforms to	SMPTE-430-1, SMPTE-430-3
Prerequisites	<i>2K FM Control Granularity - Image and Sound FM (Encrypted)</i>

A.6.15. KDM for 2K FM Payload (Encrypted)

Type	KDM
Filename	2K_fm_payload_ct.kdm.xml
Conforms to	SMPTE-430-1, SMPTE-430-3
Prerequisites	<i>2K FM Payload (Encrypted)</i>

A.6.16. KDM for Binary Audio Forensic Marking Test (Encrypted)

Type	KDM
Filename	binary_audio_fm_ct.kdm.xml
Description	KDM with "no FM mark" flag applied to audio.
Conforms to	SMPTE-430-1, SMPTE-430-3

Prerequisites	<i>Binary Audio Forensic Marking Bypass Test (Encrypted)</i>
----------------------	--

A.6.17. KDM for Binary Selective Audio Forensic Marking Test (Encrypted)

Type	KDM
Filename	binary_selective_audio_fm_6ch_ct.kdm.xml
Description	KDM with audio forensic marking disabled on audio channels above 6 using the "selective audio FM mark" command.
Conforms to	SMPTE-430-1, SMPTE-430-3
Prerequisites	<i>Binary Audio Forensic Marking Bypass Test (Encrypted)</i>

A.6.18. KDM for Selective Audio FM - All FM (Encrypted)

Type	KDM
Filename	selective_audio_fm_all-fm_ct.kdm.xml
Description	KDM with all audio forensic marking enabled on all audio channels.
Conforms to	SMPTE-430-1, SMPTE-430-3
Prerequisites	<i>Selective Audio FM - All FM (Encrypted)</i>

A.6.19. KDM for Selective Audio FM - No FM (Encrypted)

Type	KDM
Filename	selective_audio_fm_no-fm_ct.kdm.xml
Description	KDM with all audio forensic marking disabled by the "no FM mark" URI.
Conforms to	SMPTE-430-1, SMPTE-430-3
Prerequisites	<i>Selective Audio FM - No FM (Encrypted)</i>

A.6.20. KDM for Selective Audio FM - Not Above Channel 6 (Encrypted)

Type	KDM
Filename	selective_audio_fm_6ch_ct.kdm.xml
Description	KDM with audio forensic marking disabled on audio channels above 6 using the "selective audio FM mark" command. The KDM also has the "no FM mark" URI, which should be overridden by the "selective audio FM mark" URI.
Conforms to	SMPTE-430-1, SMPTE-430-3
Prerequisites	<i>Selective Audio FM - Not Above Channel 6 (Encrypted)</i>

A.6.21. KDM for Selective Audio FM - Not Above Channel 8 (Encrypted)

Type	KDM
Filename	selective_audio_fm_8ch_ct.kdm.xml
Description	KDM with audio forensic marking disabled on audio channels above 8 using the "selective audio FM mark" command.
Conforms to	SMPTE-430-1, SMPTE-430-3
Prerequisites	<i>Selective Audio FM - Not Above Channel 8 (Encrypted)</i>

A.6.22. KDM for Selective Audio FM - Not Above Channel 10 (Encrypted)

Type	KDM
Filename	selective_audio_fm_10ch_ct.kdm.xml
Description	KDM with audio forensic marking disabled on audio channels above 10 using the "selective audio FM mark" command.
Conforms to	SMPTE-430-1, SMPTE-430-3
Prerequisites	<i>Selective Audio FM - Not Above Channel 10 (Encrypted)</i>

A.6.23. KDM for Selective Audio FM - Not Above Channel 17 (Encrypted)

Type	KDM
Filename	selective_audio_fm_17ch_ct.kdm.xml
Description	KDM with audio forensic marking disabled on audio channels above 17 using the "selective audio FM mark" command. The KDM also has the "no FM mark" URI, which should be overridden by the "selective audio FM mark" URI.
Conforms to	SMPTE-430-1, SMPTE-430-3
Prerequisites	<i>Selective Audio FM - Not Above Channel 17 (Encrypted)</i>

A.6.24. KDM with two selective audio FM mark URIs

Type	KDM
Filename	kdm-malf-2-selective-fm-cmds.kdm.xml
Description	KDM that contains more than one selective audio FM mark URIs
Conforms to	SMPTE-430-1, SMPTE-430-3
Prerequisites	<i>DCI 2K StEM (Encrypted)</i>
Malformations	KDM contains one ForensicMarkFlag element with the value http://www.dcmovies.com/430-1/2006/KDM#mrkflg-audio-disable-above-channel-06 , and one ForensicMarkFlag element with the value http://www.dcmovies.com/430-1/2006/KDM#mrkflg-audio-disable-above-channel-08 .

A.6.25. KDM for 2K Maximum Bitrate Composition (Encrypted)

Type	KDM
Filename	2K_max_bitrate_ct.kdm.xml
Conforms to	SMPTE-430-1, SMPTE-430-3
Prerequisites	<i>2K DCI Maximum Bitrate Composition (Encrypted)</i>

A.6.26. KDM for 4K Maximum Bitrate Composition (Encrypted)

Type	KDM
Filename	4K_max_bitrate_ct.kdm.xml
Conforms to	SMPTE-430-1, SMPTE-430-3
Prerequisites	<i>4K DCI Maximum Bitrate Composition (Encrypted)</i>

A.6.27. KDM for Past Time Window Extension (Encrypted)

Type	KDM
Filename	holdover_long_ct-kdm-short-expire.kdm.xml
Description	KDM that has a validity period that is current, but expires in the near future
Conforms to	SMPTE-430-1, SMPTE-430-3
Prerequisites	<i>End of Engagement - Past Time Window Extension (Encrypted)</i>
Malformations	The value of the ContentKeysNotValidAfter element is a UTC timestamp no greater than 60 minutes in the future.

A.6.28. KDM for Within Time Window Extension (Encrypted)

Type	KDM
Filename	holdover_short_ct-kdm-short-expire.kdm.xml
Description	KDM that has a validity period that is current, but expires in the near future
Conforms to	SMPTE-430-1, SMPTE-430-3
Prerequisites	<i>End of Engagement - Within Time Window Extension (Encrypted)</i>
Malformations	The value of the ContentKeysNotValidAfter element is a UTC timestamp no greater than 60 minutes in the future.

A.6.29. KDM for DCI Malformed Test 1: Picture with Frame-out-of-order error (Encrypted)

Type	KDM
-------------	-----

Filename	m01_pict_frame_oo_ct.kdm.xml
Conforms to	SMPTE-430-1, SMPTE-430-3
Prerequisites	<i>DCI Malformed Test 1: Picture with Frame-out-of-order error (Encrypted)</i>

A.6.30. KDM for DCI Malformed Test 2: Sound with Frame-out-of-order error (Encrypted)

Type	KDM
Filename	m02_snd_frame_oo_ct.kdm.xml
Conforms to	SMPTE-430-1, SMPTE-430-3
Prerequisites	<i>DCI Malformed Test 2: Sound with Frame-out-of-order error (Encrypted)</i>

A.6.31. KDM for DCI Malformed Test 4: DCP With an incorrect audio TrackFile ID (Encrypted)

Type	KDM
Filename	m04_sndtk_wrong_file_ct.kdm.xml
Conforms to	SMPTE-430-1, SMPTE-430-3
Prerequisites	<i>DCI Malformed Test 4: DCP With an incorrect audio TrackFile ID (Encrypted)</i>

A.6.32. KDM for DCI Malformed Test 5: DCP With an incorrect image TrackFile ID (Encrypted)

Type	KDM
Filename	m05_pict_wrong_file_ct.kdm.xml
Conforms to	SMPTE-430-1, SMPTE-430-3
Prerequisites	<i>DCI Malformed Test 5: DCP With an incorrect image TrackFile ID (Encrypted)</i>

A.6.33. KDM for DCI Malformed Test 6: CPL with incorrect track file hashes (Encrypted)

Type	KDM
Filename	m06_cpl_hash_error_ct.kdm.xml
Conforms to	SMPTE-430-1, SMPTE-430-3
Prerequisites	<i>DCI Malformed Test 6: CPL with incorrect track file hashes (Encrypted)</i>

A.6.34. KDM for DCI Malformed Test 7: CPL with an Invalid Signature (Encrypted)

Type	KDM
Filename	m07_cpl_invalid_signature_ct.kdm.xml
Conforms to	SMPTE-430-1, SMPTE-430-3

Prerequisites	<i>DCI Malformed Test 7: CPL with an Invalid Signature (Encrypted)</i>
----------------------	--

A.6.35. KDM for DCI Malformed Test 9: Picture with HMAC error in MXF Track File (Encrypted)

Type	KDM
Filename	m09_pict_bad_hmac_ct.kdm.xml
Description	The KDM does not contain a KDM-borne MIC Key.
Conforms to	SMPTE-430-1, SMPTE-430-3
Prerequisites	<i>DCI Malformed Test 9: Picture with HMAC error in MXF Track File (Encrypted)</i>

A.6.36. KDM for DCI Malformed Test 10: Sound with HMAC error in MXF Track File (Encrypted)

Type	KDM
Filename	m10_snd_bad_hmac_ct.kdm.xml
Description	The KDM does not contain a KDM-borne MIC Key.
Conforms to	SMPTE-430-1, SMPTE-430-3
Prerequisites	<i>DCI Malformed Test 10: Sound with HMAC error in MXF Track File (Encrypted)</i>

A.6.37. KDM for DCI Malformed Test 11: Picture with Check Value error in MXF Track File (Encrypted)

Type	KDM
Filename	m11_pict_bad_chuk_ct.kdm.xml
Conforms to	SMPTE-430-1, SMPTE-430-3
Prerequisites	<i>DCI Malformed Test 11: Picture with Check Value error in MXF Track File (Encrypted)</i>

A.6.38. KDM for DCI Malformed Test 12: Sound with Check Value error in MXF Track File (Encrypted)

Type	KDM
Filename	m12_snd_bad_chuk_ct.kdm.xml
Conforms to	SMPTE-430-1, SMPTE-430-3
Prerequisites	<i>DCI Malformed Test 12: Sound with Check Value error in MXF Track File (Encrypted)</i>

A.6.39. KDM for DCI Malformed Test 13: CPL that references a non-existent track file (Encrypted)

Type	KDM
-------------	-----

Filename	m13_cpl_missing_asset_ct.kdm.xml
Conforms to	SMPTE-430-1, SMPTE-430-3
Prerequisites	<i>DCI Malformed Test 13: CPL that references a non-existent track file (Encrypted)</i>

A.6.40. KDM for DCI Malformed Test 14: CPL that does not conform to ST 429-7 (Encrypted)

Type	KDM
Filename	m14_cpl_format_error_ct.kdm.xml
Conforms to	SMPTE-430-1, SMPTE-430-3
Prerequisites	<i>DCI Malformed Test 14: CPL that does not conform to ST 429-7 (Encrypted)</i>

A.6.41. KDM for DCI Malformed Test 15: CPL signed by a certificate not conforming to ST 430-2 (Encrypted)

Type	KDM
Filename	m15_cpl_signer_format_error_ct.kdm.xml
Conforms to	SMPTE-430-1, SMPTE-430-3
Prerequisites	<i>DCI Malformed Test 15: CPL signed by a certificate not conforming to ST 430-2 (Encrypted)</i>

A.6.42. KDM for DCI Malformed Test 16: CPL signed with No Role Certificate (Encrypted)

Type	KDM
Filename	m16_cpl_malf_signer_no_role_ct.kdm.xml
Conforms to	SMPTE-430-1, SMPTE-430-3
Prerequisites	<i>DCI Malformed Test 16: CPL signed with No Role Certificate (Encrypted)</i>

A.6.43. KDM for DCI Malformed Test 17: CPL signed with Bad Role Certificate (Encrypted)

Type	KDM
Filename	m17_cpl_malf_signer_bad_role_ct.kdm.xml
Conforms to	SMPTE-430-1, SMPTE-430-3
Prerequisites	<i>DCI Malformed Test 17: CPL signed with Bad Role Certificate (Encrypted)</i>

A.6.44. KDM for DCI Malformed Test 18: KDM for CPL signed with Extra Role Certificate (Encrypted)

Type	KDM
Filename	m18_cpl_malf_signer_extra_role_ct.kdm.xml

Conforms to	SMPTE-430-1, SMPTE-430-3
Prerequisites	<i>DCI Malformed Test 18: CPL signed with Extra Role Certificate (Encrypted)</i>

A.6.45. KDM with invalid XML

Type	KDM
Filename	kdm-malf-any.kdm.xml
Description	KDM that contains an invalid XML file format
Conforms to	SMPTE-430-1, SMPTE-430-3
Prerequisites	<i>KDM for 2K StEM (Encrypted)</i>
Malformations	Missing </DCinemaSecurityMessage> tag

A.6.46. KDM that has expired

Type	KDM
Filename	kdm-expired.kdm.xml
Description	KDM that has a validity period that has expired
Conforms to	SMPTE-430-1, SMPTE-430-3
Prerequisites	<i>KDM for 2K StEM (Encrypted)</i>
Malformations	The value of the ContentKeysNotValidAfter element is a UTC timestamp at least 24 hours in the past.

A.6.47. KDM with future validity period within the UTC offset

Type	KDM
Filename	kdm-near-future.kdm.xml
Description	KDM that has a validity period in the future according to the full ContentKeysNotValidBefore timestamp but is valid now if the UTC offset is ignored.
Conforms to	SMPTE-430-1, SMPTE-430-3
Prerequisites	<i>KDM for 2K StEM (Encrypted)</i>
Malformations	The value of the ContentKeysNotValidBefore element is a UTC timestamp between 4 and 6 hours in the future, with a local offset of -06:00.

A.6.48. KDM that has recently expired

Type	KDM
Filename	kdm-recent-expired.kdm.xml

Description	KDM that has a validity period that has expired according to the full ContentKeysNotValidAfter timestamp but that has not expired if the local offset is ignored.
Conforms to	SMPTE-430-1, SMPTE-430-3
Prerequisites	<i>KDM for 2K StEM (Encrypted)</i>
Malformations	The value of the ContentKeysNotValidAfter element is a UTC timestamp between 4 and 6 hours in the past, with a local offset of +06:00.

A.6.49. KDM with incorrect message digest

Type	KDM
Filename	kdm-malf-sig-digest.kdm.xml
Description	KDM in which a Signature Digest has been altered
Conforms to	SMPTE-430-1, SMPTE-430-3
Prerequisites	<i>KDM for 2K StEM (Encrypted)</i>
Malformations	The plaintext form of the encrypted message digest in the signature is not the same value as a calculated message digest of the KDM.

A.6.50. KDM with future validity period

Type	KDM
Filename	kdm-future-cy2024.kdm.xml
Description	KDM that has a validity period that is in the future
Conforms to	SMPTE-430-1, SMPTE-430-3
Prerequisites	<i>KDM for 2K StEM (Encrypted)</i>
Malformations	The value of the ContentKeysNotValidBefore element is a UTC timestamp at least 24 hours in the future.

A.6.51. KDM with empty TDL

Type	KDM
Filename	kdm-no-tdl.kdm.xml
Description	KDM that has an empty Trusted Device List (TDL)
Conforms to	SMPTE-430-1, SMPTE-430-3
Prerequisites	<i>KDM for 2K StEM (Encrypted)</i>
Malformations	The DeviceList element of the KDM is empty.

A.6.52. KDM with Assume Trust and random TDL entries

Type	KDM
Filename	kdm-assume-trust-and-more.kdm.xml
Description	KDM with a TDL consisting of one entry Assume Trust entry (<i>i.e.</i> "2jmj7I5rSw0yVb/ vIWAYkK/YBwk=") and one random entry.
Conforms to	SMPTE-430-1, SMPTE-430-3
Prerequisites	<i>KDM for 2K StEM (Encrypted)</i>

A.6.53. KDM with the SM alone on the TDL

Type	KDM
Filename	kdm-self-tdl.kdm.xml
Description	KDM with a single entry on its TDL corresponding the recipient's SM certificate.
Conforms to	SMPTE-430-1, SMPTE-430-3
Prerequisites	<i>KDM for 2K StEM (Encrypted)</i>

A.6.54. Deleted Section

The section "KDM with the projector and LDB on the TDL" was deleted. The section number is maintained here to preserve the numbering of subsequent sections.

A.6.55. KDM with the Imaging Device alone on the TDL

Type	KDM
Filename	kdm-projector-tdl.kdm.xml
Description	KDM with a single entry on its TDL corresponding the Imaging Device SPB connected to the MB.
Conforms to	SMPTE-430-1, SMPTE-430-3
Prerequisites	<i>KDM for 2K StEM (Encrypted)</i>

A.6.56. Deleted Section

The section "KDM with the LDB alone on the TDL" was deleted. The section number is maintained here to preserve the numbering of subsequent sections.

A.6.57. Deleted Section

The section "KDM with imminent expiration date" was deleted. The section number is maintained here to preserve the numbering of subsequent sections.

A.6.58. KDM with corrupted CipherData block

Type	KDM
-------------	-----

Filename	kdm-malf-CipherData-block.kdm.xml
Description	KDM that contains an Invalid Structure ID field in the CipherData element
Conforms to	SMPTE-430-1, SMPTE-430-3
Prerequisites	<i>KDM for 2K StEM (Encrypted)</i>
Malformations	The first byte of the Structure ID field contained in the <enc:CipherValue> element inside the <enc:CipherData> element has been changed from "F1" to "1F"

A.6.59. KDM with incorrect signer thumbprint

Type	KDM
Filename	kdm-malf-signer-tp.kdm.xml
Description	KDM for which the Thumbprint of the Signer's Certificate does not match the Signer of the KDM
Conforms to	SMPTE-430-1, SMPTE-430-3
Prerequisites	<i>KDM for 2K StEM (Encrypted)</i>
Malformations	The thumbprint of the signer certificate as listed in the KDM is incorrect and does not match the thumbprint for the issuing certificate.

A.6.60. KDM without signer certificate

Type	KDM
Filename	kdm-malf-chain.kdm.xml
Description	KDM in which the Certificate chain does not contain the Signer's Certificate
Conforms to	SMPTE-430-1, SMPTE-430-3
Prerequisites	<i>KDM for 2K StEM (Encrypted)</i>
Malformations	The certificate that signed the KDM is not included in the KDM.

A.6.61. KDM without AuthorityKey certificate

Type	KDM
Filename	kdm-malf-chain-no-cert-authkeyid.kdm.xml
Description	KDM in which the Certificate chain does not contain the certificate specified by the AuthorityKeyIdentifier value in the Signer Certificate
Conforms to	SMPTE-430-1, SMPTE-430-3
Prerequisites	<i>KDM for 2K StEM (Encrypted)</i>
Malformations	A KDM that specifies the signer's issuer certificate as the AuthorityKeyIdentifier but which does not

contain that certificate.

A.6.62. KDM with KeyInfo mismatch

Type	KDM
Filename	kdm-bad-keyinfo.kdm.xml
Description	KeyInfo field of the audio EncryptedKey element does not match the KeyInfo field of the image EncryptedKey element
Conforms to	SMPTE-430-1, SMPTE-430-3
Prerequisites	<i>KDM for 2K StEM (Encrypted)</i>
Malformations	The KeyInfo element of the audio encrypted key data contains the correct Issuer Name and an incorrect IssuerSerial of the certificate of the recipient of the KDM.

A.6.63. KDM with invalid MessageType

Type	KDM
Filename	kdm-malf-bad-MessageType.kdm.xml
Description	KDM with an Invalid MessageType element
Conforms to	SMPTE-430-1, SMPTE-430-3
Prerequisites	<i>KDM for 2K StEM (Encrypted)</i>
Malformations	MessageType element contains: " http://www.smpte-qa.org/430-1/2006/KDM#kdm-key-type "

A.6.64. KDM with expired Signer certificate

Type	KDM
Filename	kdm-malf-expired-signer.kdm.xml
Description	KDM with an expired Signer's Certificate and an ETM IssueDate later than Signer's Certificate expiry date
Conforms to	SMPTE-430-1, SMPTE-430-3
Prerequisites	<i>KDM for 2K StEM (Encrypted)</i>
Malformations	KDM signer's certificate's Validity "Not After" date is earlier than ETM IssueDate

A.6.65. KDM issued before certificate valid

Type	KDM
Filename	kdm-malf-issue-before-cert-valid.kdm.xml
Description	KDM with a valid Signer's Certificate, but ETM issue date before Signer's Certificate issue date
Conforms to	SMPTE-430-1, SMPTE-430-3
Prerequisites	<i>KDM for 2K StEM (Encrypted)</i>
Malformations	The <IssueDate> element contains a date prior to the date of the signer certificate's Validity "Not Before" date.

A.6.66. KDM validity exceeds signer validity

Type	KDM
Filename	kdm-malf-signer-cert-exp-before-kdm-expires.kdm.xml
Description	KDM with a validity period that extends beyond the validity of Signer's Certificate expiry date.
Conforms to	SMPTE-430-1, SMPTE-430-3
Prerequisites	<i>KDM for 2K StEM (Encrypted)</i>
Malformations	The KDM has a ContentKeysNotValidAfter value later than the signer certificate's "Not After" value.

A.6.67. KDM with mismatched keytype

Type	KDM
Filename	kdm-malf-mismatched-key-keytype.kdm.xml
Description	KDM with an encryption key that is valid but has an incorrect keytype
Conforms to	SMPTE-430-1, SMPTE-430-3
Prerequisites	<i>KDM for 2K StEM (Encrypted)</i>
Malformations	Key is a valid image encryption key but has the keytype "MDAK".

A.6.68. KDM with non-empty NonCriticalExtensions

Type	KDM
Filename	kdm-with-non-crit-exts.kdm.xml
Description	KDM with a non-empty NonCriticalExtensions element
Conforms to	SMPTE-430-1, SMPTE-430-3
Prerequisites	<i>KDM for 2K StEM (Encrypted)</i>

A.6.69. KDM with invalid ContentAuthenticator

Type	KDM
Filename	kdm-malf-bad-ContentAuthenticator.kdm.xml
Description	KDM with an Invalid ContentAuthenticator element
Conforms to	SMPTE-430-1, SMPTE-430-3
Prerequisites	<i>KDM for 2K StEM (Encrypted)</i>
Malformations	the content of the ContentAuthenticator element shall contain a thumbprint of a D-Cinema cert that does not match one in the signer chain of the CPL that the KDM references.

A.6.70. KDM with bad CompositionPlaylistId value

Type	KDM
Filename	kdm-malf-bad-CompositionPlaylistId.kdm.xml
Description	KDM with an incorrect value in the CompositionPlaylistId element.
Conforms to	SMPTE-430-1, SMPTE-430-3
Prerequisites	<i>KDM for 2K StEM (Encrypted)</i>
Malformations	The content of the CompositionPlaylistId element shall contain a UUID value that does not match the Id value of the associated CPL.

A.6.71. KDM with bad CipherData CompositionPlaylistId value

Type	KDM
Filename	kdm-malf-bad-CipherData-CPLId.kdm.xml
Description	KDM with an incorrect value in the CompositionPlaylistId field of the CipherData structure.
Conforms to	SMPTE-430-1, SMPTE-430-3
Prerequisites	<i>KDM for 2K StEM (Encrypted)</i>
Malformations	The content of the CompositionPlaylistId field of the CipherData structure shall contain a UUID value that does not match the Id value of the associated CPL.

A.6.72. KDM with incorrect namespace name value

Type	KDM
Filename	kdm-malf-bad-namespace.kdm.xml
Description	KDM has the wrong namespace name.
Conforms to	SMPTE-430-1, SMPTE-430-3
Prerequisites	<i>KDM for 2K StEM (Encrypted)</i>

Malformations	The namespace name corresponding to the top level XML element does not match the value given in SMPTE-430-3-2006. The bogus value <code>http://www.smpte-qa.org/schemas/430-3/2001/ETM</code> shall be used.
----------------------	--

A.6.73. KDM with random TDL entry

Type	KDM
Filename	kdm-random-tdl.kdm.xml
Description	KDM has a random entry that does not match any known certificated device.
Conforms to	SMPTE-430-1, SMPTE-430-3
Prerequisites	<i>KDM for 2K StEM (Encrypted)</i>
Malformations	The DeviceInfoList contains a single entry, a randomly generated value.

A.6.74. KDM signed with incorrect signer certificate format

Type	KDM
Filename	kdm-malf-signer-format.kdm.xml
Description	KDM which has been signed with a certificate not conforming with SMPTE-430-2-2006.
Conforms to	SMPTE-430-1, SMPTE-430-3
Prerequisites	<i>KDM for 2K StEM (Encrypted)</i>
Malformations	The certificate that signed the KDM is Interop format.

A.6.75. KDM with Assume Trust TDL Entry for 2K StEM (Encrypted)

Type	KDM
Filename	kdm-assume-trust.kdm.xml
Description	KDM which has only the empty-string thumbprint "assume trust" in the TDL (<i>i.e.</i> "2jmj7I5rSw0yVb/vIWAYkK/YBwk=").
Conforms to	SMPTE-430-1, SMPTE-430-3
Prerequisites	<i>KDM for 2K StEM (Encrypted)</i>

A.6.76. Deleted Section

The section "KDM for 2K StEM with Device Specific Special Auditorium TDL" was deleted. The section number is maintained here to preserve the numbering of subsequent sections.

A.6.77. Deleted Section

The section "KDM for DCI 2K StEM with a TDL that contains all of the certificate thumbprints for the devices in the special auditorium situation" was deleted. The section number is maintained here to preserve the numbering of subsequent sections.

A.6.78. Deleted Section

The section "KDM with a TDL including Responder A" was deleted. The section number is maintained here to preserve the numbering of subsequent sections.

A.6.79. Deleted Section

The section "KDM with a TDL including Responder B" was deleted. The section number is maintained here to preserve the numbering of subsequent sections.

A.6.80. Deleted Section

The section "KDM with a TDL that contains all of the certificate thumbprints for the devices in the special auditorium situation and an additional device certificate" was deleted. The section number is maintained here to preserve the numbering of subsequent sections.

A.6.81. Deleted Section

The section "KDM with a TDL that contains all but one of the certificate thumbprints for the devices in the special auditorium situation" was deleted. The section number is maintained here to preserve the numbering of subsequent sections.

A.6.82. Deleted Section

The section "KDM with a TDL that contains all of the certificate thumbprints for the devices in the special auditorium situation and the 'assume trust' thumbprint" was deleted. The section number is maintained here to preserve the numbering of subsequent sections.

A.6.83. Deleted Section

The section "KDM with a TDL that contains one more LD/LE device thumbprints than there are LD/projector thumbprints in the special auditorium situation" was deleted. The section number is maintained here to preserve the numbering of subsequent sections.

A.6.84. Deleted Section

The section "KDM with Assume Trust TDL Entry for DCI 2K Sync Test (Encrypted)" was deleted. The section number is maintained here to preserve the numbering of subsequent sections.

A.6.85. Deleted Section

The section "KDM with a TDL that contains all of the certificate thumbprints for the devices in the special auditorium situation" was deleted. The section number is maintained here to preserve the numbering of subsequent sections.

A.6.86. KDM for 2K Scope Subtitle Test (Encrypted)

Type	KDM
Filename	sub_test_2K_scope_ct.kdm.xml
Conforms to	SMPTE-430-1, SMPTE-430-3
Prerequisites	<i>2K Scope Subtitle Test (Encrypted)</i>

A.6.87. KDM for 2K Flat Subtitle Test (Encrypted)

Type	KDM
Filename	sub_test_2K_flat_ct.kdm.xml
Conforms to	SMPTE-430-1, SMPTE-430-3
Prerequisites	<i>2K Flat Subtitle Test (Encrypted)</i>

A.6.88. KDM for 2K Full Subtitle Test (Encrypted)

Type	KDM
Filename	sub_test_2K_full_ct.kdm.xml
Conforms to	SMPTE-430-1, SMPTE-430-3
Prerequisites	<i>2K Full Subtitle Test (Encrypted)</i>

A.6.89. KDM for 4K Scope Subtitle Test (Encrypted)

Type	KDM
Filename	sub_test_4K_scope_ct.kdm.xml
Conforms to	SMPTE-430-1, SMPTE-430-3
Prerequisites	<i>4K Scope Subtitle Test (Encrypted)</i>

A.6.90. KDM for 4K Flat Subtitle Test (Encrypted)

Type	KDM
Filename	sub_test_4K_flat_ct.kdm.xml
Conforms to	SMPTE-430-1, SMPTE-430-3
Prerequisites	<i>4K Flat Subtitle Test (Encrypted)</i>

A.6.91. KDM for 4K Full Subtitle Test (Encrypted)

Type	KDM
Filename	sub_test_4K_full_ct.kdm.xml
Conforms to	SMPTE-430-1, SMPTE-430-3
Prerequisites	<i>4K Full Subtitle Test (Encrypted)</i>

A.6.92. KDM for 2K 48fps Scope Subtitle Test (Encrypted)

Type	KDM
------	-----

Filename	sub_test_48fps_scope_ct.kdm.xml
Conforms to	SMPTE-430-1, SMPTE-430-3
Prerequisites	2K 48fps Scope Subtitle Test (Encrypted)

A.6.93. KDM for 2K 48fps Flat Subtitle Test (Encrypted)

Type	KDM
Filename	sub_test_48fps_flat_ct.kdm.xml
Conforms to	SMPTE-430-1, SMPTE-430-3
Prerequisites	2K 48fps Flat Subtitle Test (Encrypted)

A.6.94. KDM for 2K 48fps Full Subtitle Test (Encrypted)

Type	KDM
Filename	sub_test_48fps_full_ct.kdm.xml
Conforms to	SMPTE-430-1, SMPTE-430-3
Prerequisites	2K 48fps Full Subtitle Test (Encrypted)

A.6.95. KDM for DCI 2K Sync Test (OBAE) (Encrypted)

Type	KDM
Filename	2K_sync_test_obae_ct.kdm.xml
Description	KDM for <u>Section A.4.107: DCI 2K Sync Test (OBAE) (Encrypted)</u>
Conforms to	SMPTE-430-1, SMPTE-430-3
Prerequisites	DCI 2K Sync Test (OBAE) (Encrypted)

A.6.96. KDM with bad CompositionPlaylistId value (OBAE)

Type	KDM
Filename	kdm-malf-bad-CompositionPlaylistId-obae.kdm.xml
Description	KDM with an incorrect value in the CompositionPlaylistId element.
Conforms to	SMPTE-430-1, SMPTE-430-3
Prerequisites	KDM for 2K StEM (Encrypted) (OBAE)
Malformations	The content of the CompositionPlaylistId element shall contain a UUID value that does not match the Id value of the associated CPL.

A.6.97. KDM with bad CipherData CompositionPlaylistId value (OBAE)

Type	KDM
Filename	kdm-malf-bad-CipherData-CPLId-obaec.kdm.xml
Description	KDM with an incorrect value in the CompositionPlaylistId field of the CipherData structure.
Conforms to	SMPTE-430-1, SMPTE-430-3
Prerequisites	<i>KDM for 2K StEM (Encrypted) (OBAE)</i>
Malformations	The content of the CompositionPlaylistId field of the CipherData structure shall contain a UUID value that does not match the Id value of the associated CPL.

A.6.98. KDM for 2K StEM (Encrypted) (OBAE)

Type	KDM
Filename	2K_StEM_obaec_ct.kdm.xml
Conforms to	SMPTE-430-1, SMPTE-430-3
Prerequisites	<i>DCI 2K StEM (OBAE) (Encrypted)</i>

A.6.99. KDM for DCI 2K Sync test with Subtitles (Encrypted)

Type	KDM
Filename	2K_sync_test_with_subs_obaec_ct.kdm.xml
Description	KDM for <i>DCI 2K Sync Test with subtitles (OBAE) (Encrypted)</i> .
Conforms to	SMPTE-430-1, SMPTE-430-3
Prerequisites	<i>DCI 2K Sync Test with subtitles (OBAE) (Encrypted)</i>

A.6.100. KDM for DCI 2K Sync test with Subtitles (Encrypted): missing picture essence key

Type	KDM
Filename	m0100_missing_key_pict.kdm.xml
Description	KDM for <i>DCI 2K Sync test with Subtitles (Encrypted)</i> .
Conforms to	SMPTE-430-1, SMPTE-430-3
Prerequisites	<i>DCI 2K Sync test with Subtitles (Encrypted)</i>
Malformations	The KDM is missing a single picture essence key used by the associated CPL.

A.6.101. KDM for DCI 2K Sync test with Subtitles (Encrypted): missing sound essence key

Type	KDM
Filename	m0102_missing_key_snd.kdm.xml

Description	KDM for <i>DCI 2K Sync test with Subtitles (Encrypted)</i> .
Conforms to	SMPTE-430-1, SMPTE-430-3
Prerequisites	<i>DCI 2K Sync test with Subtitles (Encrypted)</i>
Malformations	The KDM is missing a single sound essence key used by the associated CPL.

A.6.102. KDM for DCI 2K Sync test with Subtitles (Encrypted): missing subtitle essence key

Type	KDM
Filename	m0104_missing_key_sub.kdm.xml
Description	KDM for <i>DCI 2K Sync test with Subtitles (Encrypted)</i> .
Conforms to	SMPTE-430-1, SMPTE-430-3
Prerequisites	<i>DCI 2K Sync test with Subtitles (Encrypted)</i>
Malformations	The KDM is missing a single subtitle essence key used by the associated CPL.

A.6.103. KDM for DCI 2K Sync Test with subtitles (OBAE) (Encrypted): missing picture essence key

Type	KDM
Filename	m0106_missing_key_pict_obae.kdm.xml
Description	KDM for <i>DCI 2K Sync Test with subtitles (OBAE) (Encrypted)</i> .
Conforms to	SMPTE-430-1, SMPTE-430-3
Prerequisites	<i>DCI 2K Sync Test with subtitles (OBAE) (Encrypted)</i>
Malformations	The KDM is missing a single picture essence key used by the associated CPL.

A.6.104. KDM for DCI 2K Sync Test with subtitles (OBAE) (Encrypted): missing sound essence key

Type	KDM
Filename	m0108_missing_key_snd_obae.kdm.xml
Description	KDM for <i>DCI 2K Sync Test with subtitles (OBAE) (Encrypted)</i> .
Conforms to	SMPTE-430-1, SMPTE-430-3
Prerequisites	<i>DCI 2K Sync Test with subtitles (OBAE) (Encrypted)</i>
Malformations	The KDM is missing a single sound essence key used by the associated CPL.

A.6.105. KDM for DCI 2K Sync Test with subtitles (OBAE) (Encrypted): missing picture subtitle key

Type	KDM
Filename	m0110_missing_key_sub_obae.kdm.xml
Description	KDM for <i>DCI 2K Sync Test with subtitles (OBAE) (Encrypted)</i> .
Conforms to	SMPTE-430-1, SMPTE-430-3
Prerequisites	<i>DCI 2K Sync Test with subtitles (OBAE) (Encrypted)</i>
Malformations	The KDM is missing a single subtitle essence key used by the associated CPL.

A.6.106. KDM for DCI 2K Sync Test with subtitles (OBAE) (Encrypted): missing OBAE key

Type	KDM
Filename	m0112_missing_key_obae_obae.kdm.xml
Description	KDM for <i>DCI 2K Sync Test with subtitles (OBAE) (Encrypted)</i> .
Conforms to	SMPTE-430-1, SMPTE-430-3
Prerequisites	<i>DCI 2K Sync Test with subtitles (OBAE) (Encrypted)</i>
Malformations	The KDM is missing a single OBAE essence key used by the associated CPL.

A.6.107. KDM for M25 Composition with Malformed Integrity Pack: Missing MIC item (Picture) (Encrypted)

Type	KDM
Filename	m25_integrity_pict_mic_ct.kdm.xml
Description	KDM for <i>M25 Composition with Malformed Integrity Pack: Missing MIC item (Picture) (Encrypted)</i> .
Conforms to	SMPTE-430-1, SMPTE-430-3
Prerequisites	<i>M25 Composition with Malformed Integrity Pack: Missing MIC item (Picture) (Encrypted)</i>

A.6.108. KDM for M27 Composition with Malformed Integrity Pack: Missing TrackFileID item (Picture) (Encrypted)

Type	KDM
Filename	m27_integrity_pict_tfid_ct.cpl.xml
Description	KDM for <i>M27 Composition with Malformed Integrity Pack: Missing TrackFileID item (Picture) (Encrypted)</i> .
Conforms to	SMPTE-430-1, SMPTE-430-3

Prerequisites	<i>M27 Composition with Malformed Integrity Pack: Missing TrackFileID item (Picture) (Encrypted)</i>
----------------------	--

A.6.109. KDM for M26 Composition with Malformed Integrity Pack: Missing SequenceNumber item (Picture) (Encrypted)

Type	KDM
Filename	m26_integrity_pict_snum_ct.kdm.xml
Description	KDM for <i>M26 Composition with Malformed Integrity Pack: Missing SequenceNumber item (Picture) (Encrypted)</i> .
Conforms to	SMPTE-430-1, SMPTE-430-3
Prerequisites	<i>M26 Composition with Malformed Integrity Pack: Missing SequenceNumber item (Picture) (Encrypted)</i>

A.6.110. KDM for M28 Composition with Malformed Integrity Pack: Missing MIC item (PCM) (Encrypted)

Type	KDM
Filename	m28_integrity_snd_mic_ct.kdm.xml
Description	KDM for <i>M28 Composition with Malformed Integrity Pack: Missing MIC item (PCM) (Encrypted)</i> .
Conforms to	SMPTE-430-1, SMPTE-430-3
Prerequisites	<i>M28 Composition with Malformed Integrity Pack: Missing MIC item (PCM) (Encrypted)</i>

A.6.111. KDM for M30 Composition with Malformed Integrity Pack: Missing TrackFileID item (PCM) (Encrypted)

Type	KDM
Filename	m30_integrity_snd_tfid_ct.kdm.xml
Description	KDM for <i>M30 Composition with Malformed Integrity Pack: Missing TrackFileID item (PCM) (Encrypted)</i> .
Conforms to	SMPTE-430-1, SMPTE-430-3
Prerequisites	<i>M30 Composition with Malformed Integrity Pack: Missing TrackFileID item (PCM) (Encrypted)</i>

A.6.112. KDM for M29 Composition with Malformed Integrity Pack: Missing SequenceNumber item (PCM) (Encrypted)

Type	KDM
Filename	m29_integrity_snd_snum_ct.kdm.xml
Description	KDM for <i>M29 Composition with Malformed Integrity Pack: Missing SequenceNumber item (PCM) (Encrypted)</i> .
Conforms to	SMPTE-430-1, SMPTE-430-3

Prerequisites	<i>M29 Composition with Malformed Integrity Pack: Missing SequenceNumber item (PCM) (Encrypted)</i>
----------------------	---

A.6.113. KDM for M20 Composition with Malformed Integrity Pack: Missing MIC item (OBAE Main Sound) (Encrypted)

Type	KDM
Filename	m20_integrity_obae_ms_mic_ct.kdm.xml
Description	KDM for <i>M20 Composition with Malformed Integrity Pack: Missing MIC item (OBAE Main Sound) (Encrypted)</i> .
Conforms to	SMPTE-430-1, SMPTE-430-3
Prerequisites	<i>M20 Composition with Malformed Integrity Pack: Missing MIC item (OBAE Main Sound) (Encrypted)</i>

A.6.114. KDM for M22 Composition with Malformed Integrity Pack: Missing TrackFileID item (OBAE Main Sound) (Encrypted)

Type	KDM
Filename	m22_integrity_obae_ms_tfid_ct.kdm.xml
Description	KDM for <i>M22 Composition with Malformed Integrity Pack: Missing TrackFileID item (OBAE Main Sound) (Encrypted)</i> .
Conforms to	SMPTE-430-1, SMPTE-430-3
Prerequisites	<i>M22 Composition with Malformed Integrity Pack: Missing TrackFileID item (OBAE Main Sound) (Encrypted)</i>

A.6.115. KDM for M21 Composition with Malformed Integrity Pack: Missing SequenceNumber item (OBAE Main Sound) (Encrypted)

Type	KDM
Filename	m21_integrity_obae_ms_snum_ct.kdm.xml
Description	KDM for <i>M21 Composition with Malformed Integrity Pack: Missing SequenceNumber item (OBAE Main Sound) (Encrypted)</i> .
Conforms to	SMPTE-430-1, SMPTE-430-3
Prerequisites	<i>M21 Composition with Malformed Integrity Pack: Missing SequenceNumber item (OBAE Main Sound) (Encrypted)</i>

A.6.116. KDM for M19 Composition with Malformed Integrity Pack: Missing MIC item (OBAE) (Encrypted)

Type	KDM
Filename	m19_integrity_obae_mic_ct.kdm.xml

Description	KDM for <i>M19 Composition with Malformed Integrity Pack: Missing MIC item (OBAE) (Encrypted)</i> .
Conforms to	SMPTE-430-1, SMPTE-430-3
Prerequisites	<i>M19 Composition with Malformed Integrity Pack: Missing MIC item (OBAE) (Encrypted)</i>

A.6.117. KDM for M24 Composition with Malformed Integrity Pack: Missing TrackFileID item (OBAE) (Encrypted)

Type	KDM
Filename	m24_integrity_obae_tfid_ct.kdm.xml
Description	KDM for <i>M24 Composition with Malformed Integrity Pack: Missing TrackFileID item (OBAE) (Encrypted)</i> .
Conforms to	SMPTE-430-1, SMPTE-430-3
Prerequisites	<i>M24 Composition with Malformed Integrity Pack: Missing TrackFileID item (OBAE) (Encrypted)</i>

A.6.118. KDM for M23 Composition with Malformed Integrity Pack: Missing SequenceNumber item (OBAE) (Encrypted)

Type	KDM
Filename	m23_integrity_obae_snum_ct.kdm.xml
Description	KDM for <i>M23 Composition with Malformed Integrity Pack: Missing SequenceNumber item (OBAE) (Encrypted)</i> .
Conforms to	SMPTE-430-1, SMPTE-430-3
Prerequisites	<i>M23 Composition with Malformed Integrity Pack: Missing SequenceNumber item (OBAE) (Encrypted)</i>

A.6.119. KDM with mismatched KeyType value (OBAE)

Type	KDM
Filename	kdm-malf-mismatched-key-keytype-obae.kdm.xml
Description	KDM with an cryptographic key that is valid for an OBAE track file but has an incorrect KeyType value.
Conforms to	SMPTE-430-1, SMPTE-430-3
Prerequisites	<i>KDM for 2K StEM (Encrypted) (OBAE)</i>
Malformations	Key is a valid OBAE cryptographic key but is associated with the KeyType value "MDAK".

A.6.120. KDM with incorrect message digest (OBAE)

Type	KDM
Filename	kdm-malf-sig-digest-obaoe.kdm.xml
Description	KDM in which a Signature Digest has been altered
Conforms to	SMPTE-430-1, SMPTE-430-3
Prerequisites	<i>KDM for 2K StEM (Encrypted) (OBAE)</i>
Malformations	The plaintext form of the encrypted message digest in the signature is not the same value as a calculated message digest of the KDM.

A.6.121. KDM that has expired (OBAE)

Type	KDM
Filename	kdm-expired-obaoe.kdm.xml
Description	KDM that has a validity period that has expired
Conforms to	SMPTE-430-1, SMPTE-430-3
Prerequisites	<i>KDM for 2K StEM (Encrypted) (OBAE)</i>
Malformations	The value of the ContentKeysNotValidAfter element is a UTC timestamp at least 24 hours in the past.

A.6.122. KDM with future validity period (OBAE)

Type	KDM
Filename	kdm-future-obaoe.kdm.xml
Description	KDM that has a validity period that is in the future
Conforms to	SMPTE-430-1, SMPTE-430-3
Prerequisites	<i>KDM for 2K StEM (Encrypted) (OBAE)</i>
Malformations	The value of the ContentKeysNotValidBefore element is a UTC timestamp at least 24 hours in the future.

A.6.123. KDM with empty TDL (OBAE)

Type	KDM
Filename	kdm-no-tdl-obaoe.kdm.xml
Description	KDM that has an empty Trusted Device List (TDL)
Conforms to	SMPTE-430-1, SMPTE-430-3
Prerequisites	<i>KDM for 2K StEM (Encrypted) (OBAE)</i>
Malformations	The DeviceList element of the KDM is empty.

A.6.124. KDM with Assume Trust TDL Entry (OBAE)

Type	KDM
Filename	kdm-assume-trust-obae.kdm.xml
Description	KDM which has only the empty-string thumbprint "assume trust" in the TDL (i.e. "2jmj715rSw0yVb/vIWAYkK/YBwk=").
Conforms to	SMPTE-430-1, SMPTE-430-3
Prerequisites	<i>KDM for 2K StEM (Encrypted) (OBAE)</i>

A.6.125. KDM with invalid XML (OBAE)

Type	KDM
Filename	kdm-malf-any-obae.kdm.xml
Description	KDM that contains an invalid XML file format
Conforms to	SMPTE-430-1, SMPTE-430-3
Prerequisites	<i>KDM for 2K StEM (Encrypted) (OBAE)</i>
Malformations	Missing </DCinemaSecurityMessage> tag

A.6.126. KDM for 64 1 second reel Composition (OBAE) (Encrypted)

Type	KDM
Filename	2K_StEM_64_1_second_reels_obae_ct.kdm.xml
Conforms to	SMPTE-430-1, SMPTE-430-3
Prerequisites	<i>64 Reel Composition, 1 Second Reels (OBAE) (Encrypted)</i>

A.6.127. KDM for M40 OBAE DCP with Frame-out-of-order error (Encrypted)

Type	KDM
Filename	m40_obae_frame_oo_ct.kdm.xml
Conforms to	SMPTE-430-1, SMPTE-430-3
Prerequisites	<i>M40 OBAE DCP with Frame-out-of-order error (Encrypted)</i>

A.6.128. KDM for M41 OBAE DCP with an incorrect TrackFile ID (Encrypted)

Type	KDM
Filename	m41_obae_wrong_file_ct.kdm.xml
Conforms to	SMPTE-430-1, SMPTE-430-3

Prerequisites	<i>M41 OBAE DCP with an incorrect TrackFile ID (Encrypted)</i>
----------------------	--

A.6.129. KDM for DCI 2K Sync Test with MIC Key (OBAE) (Encrypted)

Type	KDM mkey
Filename	2K_sync_test_obae_mkey_ct.kdm.xml
Conforms to	SMPTE-430-1, SMPTE-430-3
Prerequisites	<i>DCI 2K Sync Test with MIC Key (OBAE) (Encrypted)</i>

A.6.130. KDM for M43 OBAE DCP with Check Value error in MXF Track File (Encrypted)

Type	KDM
Filename	m43_obae_bad_chuk_ct.kdm.xml
Conforms to	SMPTE-430-1, SMPTE-430-3
Prerequisites	<i>M43 OBAE DCP with Check Value error in MXF Track File (Encrypted)</i>

A.6.131. KDM with invalid MIC Key for DCI 2K Sync Test with MIC Key (OBAE) (Encrypted)

Type	KDM mkey
Filename	m120_bad_mkey_2K_sync_test_obae_mkey_ct.kdm.xml
Conforms to	SMPTE-430-1, SMPTE-430-3
Prerequisites	<i>DCI 2K Sync Test with MIC Key (OBAE) (Encrypted)</i>
Malformations	The MIC Key specified in the KDM does not match the MIC Key used to generate the MIC item in the OBAE Track File.

A.6.132. KDM with MIC Key for DCI 2K Sync Test (OBAE) (Encrypted)

Type	KDM mkey
Filename	m121_mkey_2K_sync_test_obae_ct.kdm.xml
Conforms to	SMPTE-430-1, SMPTE-430-3
Prerequisites	<i>DCI 2K Sync Test (OBAE) (Encrypted)</i>
Malformations	The KDM contains a MIC Key for an OBAE Track File that does not use a KDM-borne MIC Key.

A.6.133. KDM for Past Time Window Extension (OBAE) (Encrypted)

Type	KDM
Filename	holdover_long_obae_ct.kdm.xml
Description	KDM that has a validity period that is current, but expires in the near future

Conforms to	SMPTE-430-1, SMPTE-430-3
Prerequisites	<i>End of Engagement - Past Time Window Extension (OBAE) (Encrypted)</i>
Malformations	The value of the ContentKeysNotValidAfter element is a UTC timestamp no greater than 60 minutes in the future.

A.6.134. KDM for Within Time Window Extension (OBAE) (Encrypted)

Type	KDM
Filename	holdover_short_obae_ct.kdm.xml
Description	KDM that has a validity period that is current, but expires in the near future
Conforms to	SMPTE-430-1, SMPTE-430-3
Prerequisites	<i>End of Engagement - Within Time Window Extension (OBAE) (Encrypted)</i>
Malformations	The value of the ContentKeysNotValidAfter element is a UTC timestamp no greater than 60 minutes in the future.

A.6.135. KDM with MIC Key (Sound) for DCI 2K Sync Test (Encrypted)

Type	KDM mkey
Filename	m122_mkey_sound_2K_sync_test_ct.kdm.xml
Conforms to	SMPTE-430-1, SMPTE-430-3
Prerequisites	<i>DCI 2K Sync Test (Encrypted)</i>
Malformations	The KDM contains a MIC Key for a Sound Track File that does not use a KDM-borne MIC Key.

A.6.136. KDM with invalid MIC Key (Sound) for DCI 2K Sync Test with KDM-Borne MIC Keys (Encrypted)

Type	KDM mkey
Filename	m123_bad_mkey_sound_2K_sync_test_mkey_ct.kdm.xml
Conforms to	SMPTE-430-1, SMPTE-430-3
Prerequisites	<i>KDM for DCI 2K Sync Test with KDM-Borne MIC Keys (Encrypted)</i>
Malformations	The MIC Key specified in the KDM does not match the MIC Key used to generate the MIC item in the Sound Track File.

A.6.137. KDM with MIC Key (Picture) for DCI 2K Sync Test (Encrypted)

Type	KDM mkey
Filename	m124_mkey_pict_2K_sync_test_ct.kdm.xml

Conforms to	SMPTE-430-1, SMPTE-430-3
Prerequisites	<i>DCI 2K Sync Test (Encrypted)</i>
Malformations	The KDM contains a MIC Key for a Picture Track File that does not use a KDM-borne MIC Key.

A.6.138. KDM with invalid MIC Key (Picture) for DCI 2K Sync Test with KDM-Borne MIC Keys (Encrypted)

Type	KDM mkey
Filename	m125_bad_mkey_pict_2K_sync_test_mkey_ct.kdm.xml
Conforms to	SMPTE-430-1, SMPTE-430-3
Prerequisites	<i>KDM for DCI 2K Sync Test with KDM-Borne MIC Keys (Encrypted)</i>
Malformations	The MIC Key specified in the KDM does not match the MIC Key used to generate the MIC item in the Picture Track File.

A.6.139. KDM for M44 OBAE DCP with HMAC Value error in MXF Track File (Encrypted)

Type	KDM
Filename	m44_obae_bad_hmac_ct.kdm.xml
Conforms to	SMPTE-430-1, SMPTE-430-3
Prerequisites	<i>M44 OBAE DCP with HMAC value error in MXF Track File (Encrypted)</i>

A.6.140. KDM for 2K FM Application Constraints (OBAE)

Type	KDM
Filename	2K_fm_constraints_obae_ct.kdm.xml
Conforms to	SMPTE-430-1, SMPTE-430-3
Prerequisites	<i>2K FM Application Constraints (OBAE) (Encrypted)</i>

A.6.141. KDM for 2K FM Control Granularity - No FM (OBAE)

Type	KDM
Filename	2K_fm_control_granularity_no_fm_obae.kdm.xml
Conforms to	SMPTE-430-1, SMPTE-430-3
Prerequisites	<i>2K FM Control Granularity - No FM (OBAE) (Encrypted)</i>

A.6.142. KDM for 2K FM Control Granularity - Image Only FM (OBAE)

Type	KDM
-------------	-----

Filename	2K_fm_control_granularity_image_only_fm_obae.kdm.xml
Conforms to	SMPTE-430-1, SMPTE-430-3
Prerequisites	<i>2K FM Control Granularity - Image Only FM (OBAE) (Encrypted)</i>

A.6.143. KDM for 2K FM Control Granularity - OBAE Only FM (OBAE)

Type	KDM
Filename	2K_fm_control_granularity_obae_only_fm_obae.kdm.xml
Conforms to	SMPTE-430-1, SMPTE-430-3
Prerequisites	<i>2K FM Control Granularity - OBAE Only FM (OBAE) (Encrypted)</i>

A.6.144. KDM for 2K FM Control Granularity - Image and OBAE FM (OBAE)

Type	KDM
Filename	2K_fm_control_granularity_image_and_obae_fm_obae.kdm.xml
Conforms to	SMPTE-430-1, SMPTE-430-3
Prerequisites	<i>2K FM Control Granularity - Image and OBAE FM (OBAE) (Encrypted)</i>

A.6.145. KDM for 128 Reel Composition, "A" Series (OBAE) (Encrypted)

Type	KDM
Filename	2K_StEM_128_a_reels_obae_ct.kdm.xml
Description	KDM that has all content keys for the track files referenced by the CPL, and additionally has one each of key types FMIK, FMAK. The FMIK and FMAK key values shall be appropriate for the specifications of the FM system used by the Test Subject.
Conforms to	SMPTE-430-1, SMPTE-430-3
Prerequisites	<i>128 Reel Composition, "A" Series (OBAE) (Encrypted)</i>

A.6.146. KDM for 128 Reel Composition, "B" Series (OBAE) (Encrypted)

Type	KDM
Filename	2K_StEM_128_b_reels_obae_ct.kdm.xml
Description	KDM that has all content keys for the track files referenced by the CPL, and additionally has one each of key types FMIK and FMAK. The FMIK and FMAK key values shall be appropriate for the specifications of the FM system used by the Test Subject.
Conforms to	SMPTE-430-1, SMPTE-430-3
Prerequisites	<i>128 Reel Composition, "B" Series (OBAE) (Encrypted)</i>

A.6.147. KDM for 2K FM Payload (OBAE) (Encrypted)

Type	KDM
Filename	2K_fm_payload_obae_ct.kdm.xml
Conforms to	SMPTE-430-1, SMPTE-430-3
Prerequisites	<i>2K FM Payload (OBAE) (Encrypted)</i>

A.6.148. KDM for Maximum Bitrate OBAE (Encrypted)

Type	KDM
Filename	maximum_bitrate_24Hz_obae_ct.kdm.xml
Conforms to	SMPTE-430-1, SMPTE-430-3
Prerequisites	<i>Maximum Bitrate OBAE (Encrypted)</i>

A.6.149. KDM for Maximum Bitrate OBAE 48 fps (Encrypted)

Type	KDM
Filename	maximum_bitrate_48Hz_obae_ct.kdm.xml
Conforms to	SMPTE-430-1, SMPTE-430-3
Prerequisites	<i>Maximum Bitrate OBAE 48 fps (Encrypted)</i>

A.6.150. KDM for 2K FM Payload (plaintext OBAE) (Encrypted)

Type	KDM
Filename	2K_fm_payload_pt_obae_ct.kdm.xml
Conforms to	SMPTE-430-1, SMPTE-430-3
Prerequisites	<i>2K FM Payload (plaintext OBAE) (Encrypted)</i>

A.6.151. KDM for 2K FM Payload (OBAE) with FM Bypass (Encrypted)

Type	KDM
Filename	2K_fm_bypass_obae_ct.kdm.xml
Description	KDM with "no FM mark" flag applied to OBAE essence.
Conforms to	SMPTE-430-1, SMPTE-430-3
Prerequisites	<i>2K FM Payload (OBAE) (Encrypted)</i>

A.6.152. KDM with non-empty NonCriticalExtensions (OBAE)

Type	KDM
Filename	kdm-with-non-crit-exts-obae.kdm.xml
Description	KDM with a non-empty NonCriticalExtensions element
Conforms to	SMPTE-430-1, SMPTE-430-3
Prerequisites	<i>KDM for 2K StEM (Encrypted) (OBAE)</i>

A.6.153. KDM with expired Signer certificate (OBAE)

Type	KDM
Filename	kdm-malf-expired-signer-obae.kdm.xml
Description	KDM with an expired Signer's Certificate and an ETM IssueDate later than Signer's Certificate expiry date
Conforms to	SMPTE-430-1, SMPTE-430-3
Prerequisites	<i>KDM for 2K StEM (Encrypted) (OBAE)</i>
Malformations	KDM signer's certificate's Validity "Not After" date is earlier than ETM IssueDate

A.6.154. KDM issued before certificate valid (OBAE)

Type	KDM
Filename	kdm-malf-issue-before-cert-valid-obae.kdm.xml
Description	KDM with a valid Signer's Certificate, but ETM issue date before Signer's Certificate issue date
Conforms to	SMPTE-430-1, SMPTE-430-3
Prerequisites	<i>KDM for 2K StEM (Encrypted) (OBAE)</i>
Malformations	The <IssueDate> element contains a date prior to the date of the signer certificate's Validity "Not Before" date.

A.6.155. KDM validity exceeds signer validity (OBAE)

Type	KDM
Filename	kdm-malf-signer-cert-exp-before-kdm-expires-obae.kdm.xml
Description	KDM with a validity period that extends beyond the validity of Signer's Certificate expiry date.
Conforms to	SMPTE-430-1, SMPTE-430-3
Prerequisites	<i>KDM for 2K StEM (Encrypted) (OBAE)</i>
Malformations	The KDM has a ContentKeysNotValidAfter value later than the signer certificate's "Not After" value.

A.6.156. KDM with corrupted CipherData block (OBAE)

Type	KDM
Filename	kdm-malf-CipherData-block-obae.kdm.xml
Description	KDM that contains an Invalid Structure ID field in the CipherData element
Conforms to	SMPTE-430-1, SMPTE-430-3
Prerequisites	<i>KDM for 2K StEM (Encrypted) (OBAE)</i>
Malformations	The first byte of the Structure ID field contained in the <enc:CipherValue> element inside the <enc:CipherData> element has been changed from "F1" to "1F"

A.6.157. KDM with incorrect signer thumbprint (OBAE)

Type	KDM
Filename	kdm-malf-signer-tp-obae.kdm.xml
Description	KDM for which the Thumbprint of the Signer's Certificate does not match the Signer of the KDM
Conforms to	SMPTE-430-1, SMPTE-430-3
Prerequisites	<i>KDM for 2K StEM (Encrypted) (OBAE)</i>
Malformations	The thumbprint of the signer certificate as listed in the KDM is incorrect and does not match the thumbprint for the issuing certificate.

A.6.158. KDM with KeyInfo mismatch (OBAE)

Type	KDM
Filename	kdm-bad-keyinfo-obae.kdm.xml
Description	KeyInfo field of the audio EncryptedKey element does not match the KeyInfo field of the image EncryptedKey element.
Conforms to	SMPTE-430-1, SMPTE-430-3
Prerequisites	<i>KDM for 2K StEM (Encrypted) (OBAE)</i>
Malformations	The KeyInfo element of the audio encrypted key data contains the correct Issuer Name and an incorrect IssuerSerial of the certificate of the recipient of the KDM.

A.6.159. KDM with invalid MessageType (OBAE)

Type	KDM
Filename	kdm-malf-bad-MessageType-obae.kdm.xml
Description	KDM with an Invalid MessageType element
Conforms to	SMPTE-430-1, SMPTE-430-3

Prerequisites	<i>KDM for 2K StEM (Encrypted) (OBAE)</i>
Malformations	MessageType element contains: "http://www.smpte-qa.org/430-1/2006/KDM#kdm-key-type"

A.6.160. KDM with incorrect namespace name value (OBAE)

Type	KDM
Filename	kdm-malf-bad-namespace-obaec.kdm.xml
Description	KDM has the wrong namespace name.
Conforms to	SMPTE-430-1, SMPTE-430-3
Prerequisites	<i>KDM for 2K StEM (Encrypted) (OBAE)</i>
Malformations	The namespace name corresponding to the top level XML element does not match the value given in SMPTE-430-3-2006. The bogus value http://www.smpte-qa.org/schemas/430-3/2001/ETMshall be used.

A.6.161. KDM without signer certificate (OBAE)

Type	KDM
Filename	kdm-malf-chain-obaec.kdm.xml
Description	KDM in which the Certificate chain does not contain the Signer's Certificate
Conforms to	SMPTE-430-1, SMPTE-430-3
Prerequisites	<i>KDM for 2K StEM (Encrypted) (OBAE)</i>
Malformations	The certificate that signed the KDM is not included in the KDM.

A.6.162. KDM signed with incorrect signer certificate format (OBAE)

Type	KDM
Filename	kdm-malf-signer-format-obaec.kdm.xml
Description	KDM which has been signed with a certificate not conforming with SMPTE-430-2-2006.
Conforms to	SMPTE-430-1, SMPTE-430-3
Prerequisites	<i>KDM for 2K StEM (Encrypted) (OBAE)</i>
Malformations	The certificate that signed the KDM is Interop format.

A.6.163. KDM for DCI Malformed Test 6b: CPL with incorrect track file hashes (OBAE) (Encrypted)

Type	KDM
Filename	m06b_cpl_hash_error_obaec.ct.kdm.xml

Conforms to	SMPTE-430-1, SMPTE-430-3
Prerequisites	<i>DCI Malformed Test 6b: CPL with incorrect track file hashes (OBAE) (Encrypted)</i>

A.6.164. KDM for DCI Malformed Test 7b: CPL with an Invalid Signature (OBAE) (Encrypted)

Type	KDM
Filename	m07b_cpl_invalid_signature_obae_ct.kdm.xml
Conforms to	SMPTE-430-1, SMPTE-430-3
Prerequisites	<i>DCI Malformed Test 7b: CPL with an Invalid Signature (OBAE) (Encrypted)</i>

A.6.165. KDM for DCI Malformed Test 13b: CPL that references a non-existent track file (OBAE) (Encrypted)

Type	KDM
Filename	m13b_cpl_missing_asset_obae_ct.kdm.xml
Conforms to	SMPTE-430-1, SMPTE-430-3
Prerequisites	<i>DCI Malformed Test 13b: CPL that references a non-existent track file (OBAE) (Encrypted)</i>

A.6.166. KDM for DCI Malformed Test 14b: CPL that does not conform to ST 429-7 (OBAE) (Encrypted)

Type	KDM
Filename	m14b_cpl_format_error_obae_ct.kdm.xml
Conforms to	SMPTE-430-1, SMPTE-430-3
Prerequisites	<i>DCI Malformed Test 14b: CPL that does not conform to ST 429-7 (OBAE) (Encrypted)</i>

A.6.167. KDM for DCI Malformed Test 15b: CPL signed by a certificate not conforming to ST 430-2 (OBAE) (Encrypted)

Type	KDM
Filename	m15b_cpl_signer_format_error_obae_ct.kdm.xml
Conforms to	SMPTE-430-1, SMPTE-430-3
Prerequisites	<i>DCI Malformed Test 15b: CPL signed by a certificate not conforming to ST 430-2 (OBAE) (Encrypted)</i>

A.6.168. KDM with invalid ContentAuthenticator (OBAE)

Type	KDM
Filename	kdm-malf-bad-ContentAuthenticator-obae.kdm.xml

Description	KDM with an Invalid ContentAuthenticator element
Conforms to	SMPTE-430-1, SMPTE-430-3
Prerequisites	<i>KDM for 2K StEM (Encrypted) (OBAE)</i>
Malformations	the content of the ContentAuthenticator element shall contain a thumbprint of a D-Cinema cert that does not match one in the signer chain of the CPL that the KDM references.

A.6.169. KDM for DCI Malformed Test 16b: CPL signed with No Role Certificate (OBAE) (Encrypted)

Type	KDM
Filename	m16b_cpl_malf_signer_no_role_obae_ct.kdm.xml
Conforms to	SMPTE-430-1, SMPTE-430-3
Prerequisites	<i>DCI Malformed Test 16b: CPL signed with No Role Certificate (OBAE) (Encrypted)</i>

A.6.170. KDM for DCI Malformed Test 17b: CPL signed with Bad Role Certificate (OBAE) (Encrypted)

Type	KDM
Filename	m17b_cpl_malf_signer_bad_role_obae_ct.kdm.xml
Conforms to	SMPTE-430-1, SMPTE-430-3
Prerequisites	<i>DCI Malformed Test 17b: CPL signed with Bad Role Certificate (OBAE) (Encrypted)</i>

A.6.171. KDM for DCI Malformed Test 18b: KDM for CPL signed with Extra Role Certificate (OBAE) (Encrypted)

Type	KDM
Filename	m18b_cpl_malf_signer_extra_role_obae_ct.kdm.xml
Conforms to	SMPTE-430-1, SMPTE-430-3
Prerequisites	<i>DCI Malformed Test 18b: CPL signed with Extra Role Certificate (OBAE) (Encrypted)</i>

A.6.172. KDM that has recently expired (OBAE)

Type	KDM
Filename	kdm-recent-expired_obae.kdm.xml
Description	KDM that has a validity period that has expired according to the full ContentKeysNotValidAfter timestamp but that has not expired if the local offset is ignored.
Conforms to	SMPTE-430-1, SMPTE-430-3

Prerequisites	<i>KDM for 2K StEM (Encrypted) (OBAE)</i>
Malformations	The value of the ContentKeysNotValidAfter element is a UTC timestamp between 4 and 6 hours in the past, with a local offset of +06:00.

A.6.173. KDM for DCI 2K Sync Test with subtitles (OBAE) (Encrypted)

Type	KDM
Filename	2K_sync_test_with_subs_obae_ct.kdm.xml
Description	<i>KDM for DCI 2K Sync Test with subtitles (OBAE) (Encrypted).</i>
Conforms to	SMPTE-430-1, SMPTE-430-3
Prerequisites	<i>DCI 2K Sync Test with subtitles (OBAE) (Encrypted)</i>

A.6.174. KDM for DCI 2K Image with Frame Number Burn In (OBAE) (Encrypted)

Type	KDM
Filename	frame_num_burn_in_obae_ct.kdm.xml
Description	<i>KDM for DCI 2K Image with Frame Number Burn In (OBAE) (Encrypted).</i>
Conforms to	SMPTE-430-1, SMPTE-430-3
Prerequisites	<i>DCI 2K Image with Frame Number Burn In (OBAE) (Encrypted)</i>

A.6.175. KDM for 2K DCI Maximum Bitrate Composition (OBAE) (Encrypted)

Type	KDM
Filename	2K_max_bitrate_obae_ct.kdm.xml
Conforms to	SMPTE-430-1, SMPTE-430-3
Prerequisites	<i>2K DCI Maximum Bitrate Composition (OBAE) (Encrypted)</i>

A.6.176. KDM for DCI 2K Sync Test with KDM-Borne MIC Keys (Encrypted)

Type	KDM mkey
Filename	2K_sync_test_mkey_ct.kdm.xml
Conforms to	SMPTE-430-1, SMPTE-430-3
Prerequisites	<i>DCI 2K Sync Test with KDM-Borne MIC Keys (Encrypted)</i>

A.6.177. KDM for Audio Tone Multi-Reel (Encrypted)

Type	KDM mkey
Filename	audio_tone_multi_ct.kdm.xml

Conforms to	SMPTE-430-1, SMPTE-430-3
Prerequisites	<i>DCP for Audio Tone Multi-Reel (Encrypted)</i>

APPENDIX B. EQUIPMENT LIST

B.1. Hardware

AES3 Audio Analyzer

Digital audio signal analyzer with AES-3 inputs.

Sound System

5.1 or 7.1 sound system with calibrated level control.

Computer with POSIX OS

Computer with POSIX-like Operating System (OS), such as Linux or Mac OS X. The system must support TCP/IP via 1000 Mb/s ethernet and be backward-compatible to support 100 Mb/s Ethernet.

Digital Clock

Digital quartz time-of-day clock displaying time accurate to the second

Direct View Display

Light emission display comprised of a combination of individual display cabinets conjoined so as to form a single large display.

Oscilloscope

Digital storage oscilloscope, 200 MHz or better, with two or more inputs plus external trigger.

Accurate Real-Time Clock

A real-time clock that uses an external reference to maintain precise time (within 1 ms). The external reference should be WWV, GPS or NTP traceable to a trusted hardware clock.

FM Decoder

Forensic mark decoder for image, sound or OBAE essence. The exact type of decoder is dependent upon the type of watermark to be decoded. This equipment is expected to collect the full payload of the forensic marking system.

FM Detector

Forensic mark detector for image or sound essence. The exact type of detector is dependent upon the type of watermark to be detected. This equipment is expected to simply detect the presence of the forensic mark.

Ethernet Switch

A 1000Base-T Ethernet switch capable of sustained full-rate throughput on at least two portpairs. The device must also be able to configure one or more ports as "monitor" ports (selected traffic on the switch can be copied to the monitor port to facilitate diagnostic capture).

Photodiode

Photodiode, of the type most sensitive in the human visible electromagnetic spectrum (about 390 nm to 780 nm), fitted with suitable length of shielded cable, terminated in a BNC connector.

Spectroradiometer

Spectroradiometer as described in [SMPTE-431-1].

Stopwatch

Digital stopwatch with .01 second resolution.

Still Camera

Digital still image camera.

48 fps Camera

Camera and recorder/reproducer system capable of 48fps (or better) capture rate.

SPB-2 Access Tools

Tools, supplied by the manufacturer of an SPB-2 device, required to gain authorized access to the protected area of the SPB-2.

Dual-Link Monitor

Dual-link HD monitor.

Bridge Tap Connector

Connector with a bridge tap takeoff point, e.g. a "BNC Tee".

GPIO Test Fixture

A test fixture comprising L.E.D. indicators, switches and a power supply, per the schematic in Appendix E.

DCI Projector

DCI-compliant standalone projector.

DCI Server

DCI-compliant server (includes Image/Sound Media Block)

LDB Monitor

LDB diagnostic utility

Digital Audio Recorder

Audio recorder capable of bit-accurate capture of digital audio channels, e.g. AES/EBU channels.

OBAE Sound System

Calibrated OBAE reproduction environment and system.

B.2. Software**Audio Editor**

A digital audio workstation (DAW), such as Pro Tools or Audacity.

ftlint

The ftlint command line utility from the FreeType library.
It is available from <http://www.freetype.org/>.

Network Analyzer

Network analysis tool such as Wireshark or tcpdump.
It is available from <http://www.wireshark.org/>.

Text Editor

Any text editor that can display and write plain text, such as emacs or vi, etc.

Sound Editor

Any sound editing software that provides sample-accurate manipulations of audio waveforms.

OpenJPEG

JPEG 2000 encoder/decoder software such as OpenJPEG.
It is available from <http://www.openjpeg.org/>.

j2c-scan

JPEG 2000 scanner based on the **OpenJPEG** library. The source code for this program is available in Section C.8.

identify

identify is part of the ImageMagick library and utility suite.
It is available from <http://www.imagemagick.org/>.

klvwalk

The klvwalk utility from the free asdcplib software package.
It is available from <http://www.cinecert.com/asdcplib/>

asdcplib-test

The asdcplib-test utility from the free asdcplib software package.
It is available from <http://www.cinecert.com/asdcplib/>.

openssl

General purpose command line utility from the OpenSSL software package.
It is available from <http://www.openssl.org/>.

schema-check

Validating XML Parser (note: may use parser from Xerces package). The source code for this program is available in [Section C.3](#).
It is available from <http://xml.apache.org/security/>.

checksig

XML Signature validator, distributed with the XML Security library.
It is available from <http://xml.apache.org/security/>.

dsig_cert.py

XML Signature certificate manipulator. The source code for this program is available in [Section C.8](#).

dsig_extract.py

XML Signature certificate extractor. The source code for this program is available in [Section C.9](#).

uuid_check.py

UUID validator. The source code for this program is available in [Section C.7](#).

dc-thumbprint

Certificate thumbprint calculator. The source code for this program is available in [Section C.2](#).

kdm-decrypt

KDM decryption tool. The source code for this program is available in [Section C.4](#).

APPENDIX C. SOURCE CODE

C.1. Overview

Wherever possible, the computer programs used in the test procedures in this document are freely available. Where appropriate, the listings in [Appendix B](#) provide a URL where the software can be obtained.

In some cases, it was necessary to develop programs because free alternatives were not available. Those programs are presented here in source code form along with instructions for building and executing the programs.

The programs are expressed in the C, C++ and Python programming languages. Build instructions and prerequisites for the C and C++ programs are given in the comments at the beginning of each source module. Machine readable copies of the programs are available in the `source-code` directory in the Reference Materials distribution (see [Appendix A](#)).

C.2. dc-thumbprint

This program reads a PEM formatted X509 certificate and calculates a SHA-1 message digest over the signed portion of the certificate as required by [SMPTE-430-2] . The value is encoded as a Base64 string and returned on `stdout`. The following example illustrates this usage:

```
$ dc-thumbprint my-cert.pem  
aZMVnZ/TzEvLUCmQFcc8U0je9uo=
```

Example C.1. dc-thumbprint execution

C.2.1. dc-thumbprint Source Code Listing

```

/*
 * dc-thumbprint.c -- calculate certificate thumbprint of PEM-encoded
 *                    X.509 document per SMPTE 430-2
 *
 * $Id$
 *
 * This program requires OpenSSL. To build:
 * $ cc -o dc-thumbprint dc-thumbprint.c -lcrypto
 */

#include <errno.h>
#include <stdio.h>
#include <string.h>
#include <openssl/crypto.h>
#include <openssl/err.h>
#include <openssl/evp.h>
#include <openssl/pem.h>
#include <openssl/x509.h>

int
main(int argc, char* argv[])
{
    /* pointer to SHA-1 hash details */
    const EVP_MD *md = EVP_sha1();
    /* PEM source file pointer */
    FILE *fp = NULL;
    /* pointer to an X509 structure */
    X509 *x = NULL;
    /* pointer to DER-encoded TBSCertificate */
    unsigned char *p_tbs = NULL;
    /* length of DER-encoded TBSCertificate (p_tbs) */
    int tbs_len = 0;
    /* buffer for the message digest */
    unsigned char md_value[EVP_MAX_MD_SIZE];
    /* return value from digest calculation */
    int digest_rc = 0;
    /* buffer for base64 encoding of the message digest */
    char md_base64[EVP_MAX_MD_SIZE * 4 / 3 + 2];

    if (argc != 2)
    {
        fprintf(stderr, "Usage: dc-thumbprint cert-file.pem\n");
        return 1;
    }

    fp = fopen(argv[1], "r");
    if (fp == NULL)
    {
        fprintf(stderr, "ERROR: Cannot open %s: %s\n", argv[1], strerror(errno));
        return 2;
    }

    x = PEM_read_X509(fp, NULL, NULL, NULL);
    (void) fclose(fp);
    if (x == NULL)
    {
        ERR_print_errors_fp(stderr);
        return 3;
    }

    /* get the tbsCertificate as a DER string */
    tbs_len = i2d_re_X509_tbs(x, &p_tbs);
    X509_free(x);
    if (tbs_len <= 0)

```

C.3. schema-check

This program parses and validates XML instance documents. When an XML document is specified alone, the file is checked for well-formedness but is not validated. When an XML document is specified with one or more schema files, **schema-check** validates that file against the schemas. Only one file to be tested may be specified at a time. Note that schema files must be listed in order of dependency (most dependent last). The following example illustrates using the program to check well-formedness:

```
$ schema-check perfect-movie.cpl.xml
```

Example C.2. Using schema-check to check well-formedness

The next example shows how to use the program to check for valid content:

```
$ schema-check perfect-movie.cpl.xml SMPTE-428-7.xsd
```

Example C.3. Using schema-check to check validity

C.3.1. schema-check Source Code Listing

```

//
// schema-check.cpp -- test XML document against schema
//
// $Id$
//
// This program requires the Xerces-c XML library. To build:
// $ c++ -o schema-check schema-check.cpp -lxerces-c
//

#include <iostream>
#include <list>
#include <string>
#include <cstdio>

#include <xercesc/util/OutOfMemoryException.hpp>
#include <xercesc/dom/DOM.hpp>
#include <xercesc/parsers/XercesDOMParser.hpp>
#include <xercesc/framework/XMLGrammarDescription.hpp>
#include <xercesc/sax/ErrorHandler.hpp>
#include <xercesc/sax/SAXParseException.hpp>

using std::cerr;
using std::endl;
XERCES_CPP_NAMESPACE_USE

// -----
// Utility code adapted from the DOMPrint program distributed with Xerces-c

// simple transcoding wrapper
class StrX
{
    char* fLocalForm;

public:
    StrX(const XMLCh* const toTranscode) { fLocalForm = XMLString::transcode(toTranscode); }
    ~StrX() { XMLString::release(&fLocalForm); }
    const char* localForm() const { return fLocalForm; }
};

std::ostream&
operator<<(std::ostream& target, const StrX& toDump)
{
    target << toDump.localForm();
    return target;
}

// error handler interface
class DOMTreeErrorReporter : public ErrorHandler
{
public:
    void warning(const SAXParseException& toCatch) {}
    void resetErrors() {}

    void error(const SAXParseException& toCatch) {
        cerr << "Error at file \"" << StrX(toCatch.getSystemId())
            << "\", line " << toCatch.getLineNumber()
            << ", column " << toCatch.getColumnNumber() << endl
            << " Message: " << StrX(toCatch.getMessage()) << endl;
    }

    void fatalError(const SAXParseException& toCatch) {
        cerr << "Fatal Error at file \"" << StrX(toCatch.getSystemId())
            << "\", line " << toCatch.getLineNumber()
            << ", column " << toCatch.getColumnNumber() << endl
            << " Message: " << StrX(toCatch.getMessage()) << endl;
    }
};

```

C.4. kdm-decrypt

This program reads a KDM and an RSA private key in PEM format and decrypts the EncryptedKey elements in the KDM. The decrypted key blocks are printed to `stdout`. Note that key blocks in the KDM must have been encrypted using the public key which corresponds to the RSA key given as the second argument to this program.

```
$ kdm-decrypt test_file.kdm.xml my_id_key.pem
CipherDataID: f1dc124460169a0e85bc300642f866ab
SignerThumbprint: q50qr6GkfG6W2HzcBTee5m0Qjzw=
  CPL Id: 119d8990-2e55-4114-80a2-e53f3403118d
  Key Id: b6276c4b-b832-4984-aab6-250c9e4f9138
  Key Type: MDIK
  Not Before: 2007-09-20T03:24:53-00:00
  Not After: 2007-10-20T03:24:53-00:00
  Key Data: 7f2f711f1b4d44b83e1dd1bf90dc7d8c
```

Example C.4. kdm-decrypt execution

C.4.1. kdm-decrypt Source Code Listing

```

//
// kdm-decrypt.cpp -- decrypt and display KDM EncryptedKey elements
//
// $Id$
//
// This program requires the Xerces-c XML, XMLSecurity, OpenSSL
// and asdcplib libraries. To build:
//
// c++ -o kdm-decrypt kdm-decrypt.cpp
//     -lxerces-c -lxml-security-c -lkumu -lcrypto
//
#include <KM_util.h>
#include <KM_fileio.h>
#include <ctype.h>
#include <iostream>
#include <string>
#include <openssl/pem.h>
#include <xercesc/util/OutOfMemoryException.hpp>
#include <xercesc/parsers/XercesDOMParser.hpp>
#include <xercesc/framework/MemBufInputSource.hpp>
#include <xsec/framework/XSECPProvider.hpp>
#include <xsec/framework/XSECException.hpp>
#include <xsec/enc/XSECCryptoException.hpp>
#include <xsec/enc/OpenSSL/OpenSSLCryptoKeyRSA.hpp>

XERCES_CPP_NAMESPACE_USE
using std::cout;
using std::cerr;
using std::endl;
using namespace Kumu;

const size_t KeyType_Length = 4;
const size_t DateTime_Length = 25;
const ui32_t X509Thumbprint_Length = 20;

// A structure to hold key block data retrieved during a decrypt operation.
struct S430_2_KeyBlock
{
    byte_t CipherDataID[UUID_Length];
    byte_t SignerThumbprint[X509Thumbprint_Length];
    byte_t CPLId[UUID_Length];
    byte_t KeyType[KeyType_Length];
    byte_t KeyId[UUID_Length];
    byte_t NotBefore[DateTime_Length];
    byte_t NotAfter[DateTime_Length];
    byte_t KeyData[SymmetricKey_Length];

    S430_2_KeyBlock() {
        memset(this, 0, sizeof(S430_2_KeyBlock));
    }

    std::string Dump() const;
};

std::string safe_char(char c) {
    char b[2] = {'*', 0};
    if ( isprint(c) ) b[0] = c;
    return b;
}

// Pretty-print key block data.
std::string
S430_2_KeyBlock::Dump() const
{

```

C.5. j2c-scan

This program reads a JPEG 2000 codestream from a file and produces parametric data on the standard output. The following example illustrates this usage:

```
$ j2c-scan test_frame_000002.j2c
coding parameters
  digital cinema profile: none
  rsiz capabilities: standard
  pixel offset from top-left corner: (0, 0)
  tile width/height in pixels: (2048, 1080)
  image width/height in tiles: (1, 1)
  tile #1
    coding style: 1
    progression order: Component-Position-Resolution-Layer
    POC marker flag: 0
    number of quality layers: 1
      rate for layer #1: 0.0
    multi-component transform flag: 1
    component #1
      coding style: 1
      number of resolutions: 6
      code block width/height: (5, 5)
      code block coding style: 0
      discrete wavelet transform identifier: 0
      quantization style: 2
      number of guard bits: 1
      step size pairs: 16
      region of interest shift: 0
    component #2
      coding style: 1
      number of resolutions: 6
      code block width/height: (5, 5)
      code block coding style: 0
      discrete wavelet transform identifier: 0
      quantization style: 2
      number of guard bits: 1
      step size pairs: 16
      region of interest shift: 0
    component #3
      coding style: 1
      number of resolutions: 6
      code block width/height: (5, 5)
      code block coding style: 0
      discrete wavelet transform identifier: 0
      quantization style: 2
      number of guard bits: 1
      step size pairs: 16
      region of interest shift: 0
```

Example C.5. j2c-scan execution

C.5.1. j2c-scan Source Code Listing

```

/*
 * j2c-scan.cpp -- parse j2c file and display data concerning it
 *
 * $Id$
 *
 * This program requires version 1.5.2 of the OpenJPEG
 * library. Furthermore, it requires the header files "openjpeg.h" and
 * "j2k.h" from its source distribution. Copy these headers to your
 * build directory. After doing so, execute the following to build:
 * $ c++ -o j2c-scan j2c-scan.cpp -lopenjpeg
 */

#include <stdio.h>
#include <string.h>
#include <stdlib.h>
#include "openjpeg.h"
#include "j2k.h"

static void
j2k_dump_cp (opj_image_t * image, opj_cp_t * cp)
{
    const char *s;
    int i, j;
    int step_size_pairs;
    printf ("coding parameters\n");
    if (cp->comment != NULL)
    {
        printf (" coding comment: %p\n", cp->comment);
    }
    switch (cp->cinema)
    {
        case OFF:      s = "none";      break;
        case CINEMA2K_24:  s = "2k @ 24 fps";      break;
        case CINEMA2K_48:  s = "2k @ 48 fps";      break;
        case CINEMA4K_24:  s = "4k @ 24 fps";      break;
        default:      s = "unknown";      break;
    }
    printf (" digital cinema profile: %s\n", s);
    switch (cp->rsiz)
    {
        case STD_RSIZ:      s = "standard";      break;
        case CINEMA2K:      s = "2k digital cinema";      break;
        case CINEMA4K:      s = "4k digital cinema";      break;
        default:      s = "unknown";      break;
    }
    printf (" rsiz capabilities: %s\n", s);
    printf (" pixel offset from top-left corner: (%d, %d)\n", cp->tx0,
        cp->ty0);
    printf (" tile width/height in pixels: (%d, %d)\n", cp->tdx, cp->tdy);
    printf (" image width/height in tiles: (%d, %d)\n", cp->tw, cp->th);
    for (i = 0; i < cp->tw * cp->th; i++)
    {
        printf (" tile #%d\n", i + 1);
        printf (" coding style: %x\n", cp->tcps[i].csty);
        switch (cp->tcps[i].prg)
        {
            case LRCP:      s = "Layer-Resolution-Component-Position";      break;
            case RLCP:      s = "Resolution-Layer-Component-Position";      break;
            case RPCL:      s = "Resolution-Position-Component-Layer";      break;
            case PCRL:      s = "Position-Component-Resolution-Layer";      break;
            case CPRL:      s = "Component-Position-Resolution-Layer";      break;
            default:      s = "unknown";      break;
        }
        printf (" progression order: %s\n", s);
        printf (" POC marker flag: %d\n", cp->tcps[i].POC);
    }
}

```

C.6. Deleted Section

The section "eab_calc.py" was deleted. The section number is maintained here to preserve the numbering of subsequent sections.

C.7. uuid_check.py

This program reads one or more XML files containing d-cinema metadata and tests each of the UUID values for compliance with [RFC-4122]. The program will emit a message on `stderr` for each malformed UUID that is encountered. The following example illustrates this usage for a KDM file:

```
$ uuid_check.py Example.kdm.xml
UUID: 7556bff9-58f9-4320-bb1f-fb594219a957
UUID: bdb3a717-5062-4822-8dfc-0dc6570cc116
UUID: 71f7926e-8ce6-4763-b14b-0ef7dcd952f5
UUID: 6083adad-472c-43da-b131-c6dc601cd154
UUID: aeaae312-a257-11da-a601-8b319b685f8e
```

Example C.7. `uuid_check.py` execution

C.7.1. uuid_check Source Code Listing

```

#!/usr/bin/env python
#
# uuid_check.py -- Scan an XML file and see that all UUID values
#                  conform to RFC-4122
#
# $Id$
#
from __future__ import print_function

import sys, re

# regular expressions for use below
urn_uuid_re = re.compile('urn:uuid:([^\<]*)')
uuid_re = re.compile('^[0-9a-f]{8}-[0-9a-f]{4}-\
([1-5])[0-9a-f]{3}-[8-9a-b][0-9a-f]{3}-[0-9a-f]{12}$', re.IGNORECASE)

#
def uuid_scan(text):
    uuid_list = []
    while text:
        match = urn_uuid_re.search(text)
        if not match: break

        uuid_val = match.group(1)
        text = text[match.end():]

        match = uuid_re.match(uuid_val)
        if not match:
            sys.stderr.write("urn:uuid: value is not an RFC-4122 UUID: %s\n" % (uuid_val))
            continue

        type = int(match.group(1)[0])
        if type not in (1, 4, 5):
            sys.stderr.write("Unexpected UUID type: %d for value %s\n" % (type, uuid_val))

        uuid_list.append(uuid_val)

    return uuid_list

#
#
if len(sys.argv) < 2:
    sys.stderr.write("usage: uuid_check.py <xml-file> [...] \n")
    sys.exit(1)

for filename in sys.argv[1:]:
    try:
        handle = open(filename)
        text = handle.read()
        handle.close()

    except Exception as e:
        print("{0}: {1}".format(filename, e))

    else:
        for uuid in uuid_scan(text):
            print("UUID: {0}".format(uuid))

#
# end uuid_check.py
#

```

C.8. dsig_cert.py

This program reads a signed XML file and re-writes the file to the standard output using the certificate order expected by the **checksig** program from the XML Security package. The following example illustrates this usage for a KDM file:

```
$ dsig_cert.py test-kdm.xml >tmp.xml
$ checksig tmp.xml
Signature verified OK!
```

Example C.8. dsig_cert.py execution

C.8.1. dsig_cert.py Source Code Listing

```

#!/usr/bin/env python
#
# dsig_cert.py -- Re-order certificates in an XML signature
#
# NOTE: This program requires Python 2.7 or greater
#
# $Id$
#
from __future__ import print_function

import sys, re
from subprocess import Popen, PIPE

# regular expressions for use below
SignatureValue_end_re = re.compile('</(?:[\w\ -]+)?SignatureValue[>]*>')
X509Data_re = re.compile('<(?:[\w\ -]+:)?X509Data[>]*>(.*?)</(?:[\w\ -]+:)?X509Data\s*>\s+',
                          re.DOTALL)
X509Certificate_re = re.compile('X509Certificate[>]*>(.*?)</', re.DOTALL)
dnQualifier_re = re.compile('dnQualifier=([\w+/\ ]+=)')

#
def get_dnq_type(pem_text, type):
    """Extract the dnQualifier value for the given certificate and common name."""
    handle = Popen(['/usr/bin/openssl', 'x509', '-noout', '-' + type],
                  stdin=PIPE, stdout=PIPE, close_fds=True)

    handle.stdin.write(pem_text)
    handle.stdin.close()
    name_text = handle.stdout.read()
    handle.wait()

    if handle.returncode != 0:
        raise Exception("No X509Certificate element in {0}".format(pem_text))

    dnq = dnQualifier_re.search(name_text.replace('\n', ''))
    if not dnq:
        raise Exception("Error retrieving dnQualifier from {0}".format(type))

    return dnq.group(1)

#
def PEMify(base64_text):
    """ create canonical PEM lines from any base64 input"""
    in_text = re.sub('[\r\n]', '', base64_text)
    idx = 0
    end = len(in_text)
    retval = ''
    while idx < end:
        retval += in_text[idx:idx+64] + '\n'
        idx += 64

    return retval

#
class dsig_certificate_set:
    """An object for manipulating XML Signature certificates."""
    def __init__(self, xml_doc):
        """Initialize with a signed XML document string."""
        body_end = SignatureValue_end_re.search(xml_doc)

        if not body_end:
            raise Exception("Document does not contain a SignatureValue element.")

        self.kdm_head = xml_doc[:body_end.end()]
        xml_doc = xml_doc[body_end.end():]

```

C.9. dsig_extract.py

This program reads a signed XML file and writes the certificates contained within to individual PEM files. As shown below, the `-p` option can be used to provide a prefix for the automatically-generated filenames. In this example, the input document contained four certificates.

```
$ dsig_extract.py -p my_prefix_ test-kdm.xml
$ ls my_prefix_*
my_prefix_1.pem
my_prefix_2.pem
my_prefix_3.pem
my_prefix_4.pem
```

Example C.9. dsig_extract.py execution

C.9.1. dsig_extract.py Source Code Listing

```
#!/usr/bin/env python
#
# dsig_extract.py -- Extract certificates from an XML signature
#
# $Id$
#
from __future__ import print_function

from dsig_cert import dsig_certificate_set
import sys

prefix = 'xmldsig_cert_'
filename = None

def usage():
    sys.stderr.write("usage: dsig_extract.py [-p <prefix>] <xml-file>\n")
    sys.exit(1)

if len(sys.argv) < 2:
    usage()

if sys.argv[1] == '-p':
    if len(sys.argv) < 4:
        usage()
    prefix = sys.argv[2]
    filename = sys.argv[3]
else:
    filename = sys.argv[1]

try:
    handle = open(filename)
    text = handle.read()
    handle.close()

    set = dsig_certificate_set(text)
    set.write_certs(prefix=prefix)

except Exception as e:
    print(e)

#
# end dsig_extract.py
#
```

APPENDIX D. DELETED SECTION

The section "ASM Simulator" was deleted. The section number is maintained here to preserve the numbering of subsequent sections.

APPENDIX E. GPIO TEST FIXTURE

The GPIO test fixture has eight outputs, which connect to ground via normally-open switch contacts. These outputs are expected to interface to command and/or status inputs of the d-cinema equipment under test.

The fixture has eight inputs, which connect to powered, current limited LEDs and will illuminate when the corresponding input is grounded. These inputs interface to command and/or status outputs of the d-cinema equipment under test.

Example circuits are provided below. Interface of outputs, inputs and ground is made via a single DB-25 female connector on the test fixture.

Testing Entities are not required to follow the above design, and are free to develop their own equipment and connector standards. The manufacturer of the d-cinema equipment being tested is responsible for providing a cable, appropriate for the individual Test Subject, that will interface to the test fixture being used.

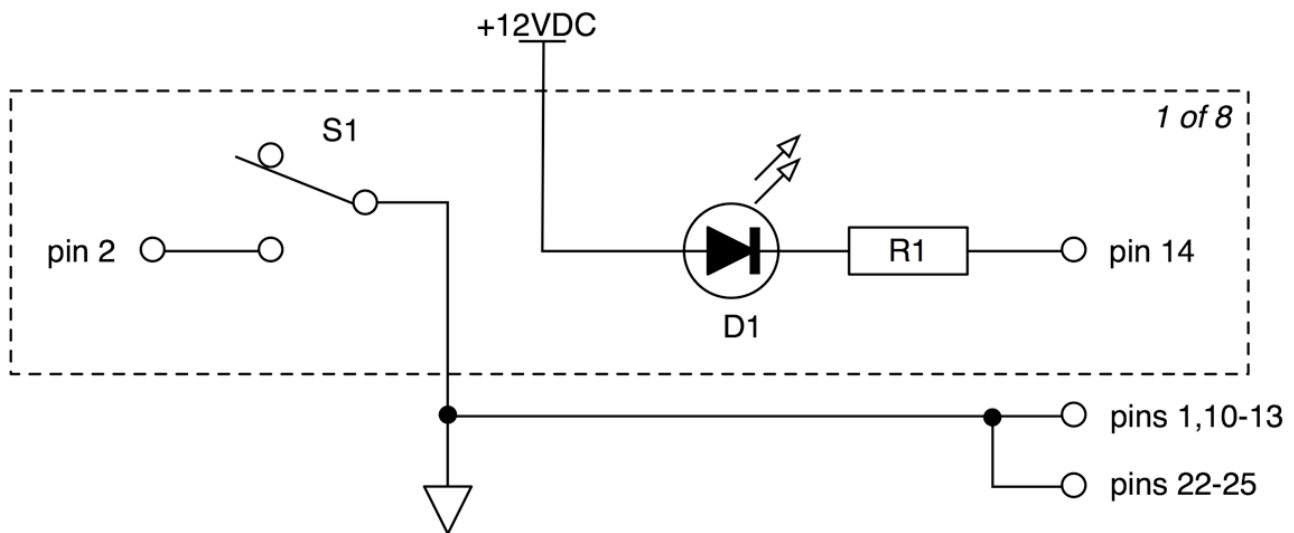

Figure E.1. GPIO Test Fixture Schematic

Note that the LED inputs are internally current limited. External devices will be expected to sink 25mA per channel. Also, the test fixture has an integral PSU (the PSU may be external but it must use a different connector).

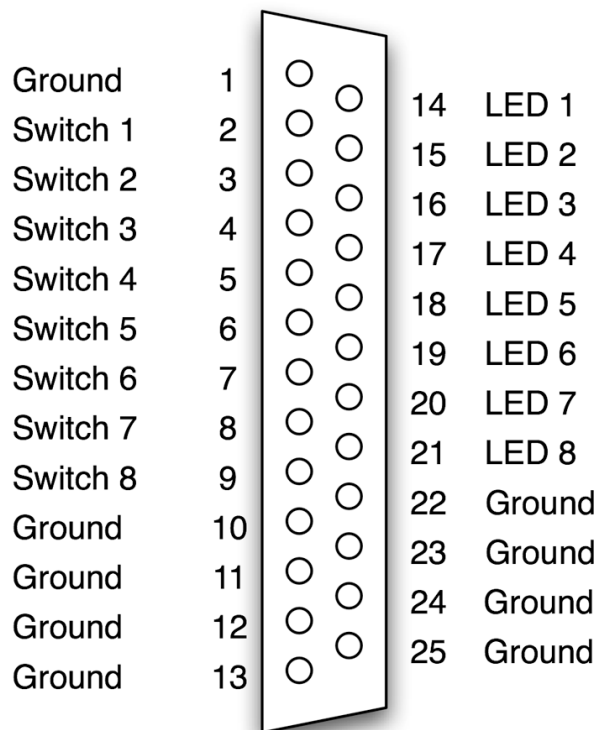

Figure E.2. GPIO Test Fixture Connector

APPENDIX F. REFERENCE DOCUMENTS

AES3-2003

AES standard for digital audio - Digital input-output interfacing - Serial transmission format for two-channel linearly represented digital audio data, Audio Engineering Society, September 9, 2003

CIE-15-2004

Colorimetry, 3rd Edition, International Commission on Illumination, 2004

DCI-DCSS

Digital Cinema System Specification Version 1.4.2, DCI, June 15, 2022.
<https://dcss.dcimovies.com/0c0cff34d231b516cb89ae3fad352d5cf37a9515/dcss.html>

DCI-DCSS-ERR-20110420

Digital Cinema System Specification Version 1.2, erratum dated April 20, 2011, DCI-DCSS-ERR-20110420.
https://www.dcimovies.com/archives/spec_v1_2_No_Errata_Incorporated/errata_1-96_aug30/ERRATA_34-76_2011-04-20_TO_DCI_DCS.html

DCI-DCSS-ERR-20160830

Digital Cinema System Specification Version 1.2, erratum dated August 12, 2012, DCI.
https://www.dcimovies.com/archives/spec_v1_2_No_Errata_Incorporated/errata_1-96_aug30/DCI-Errata_90-96_v1-2_08-30-2012.html

DCI-DCSS-ERR-20160428

Digital Cinema System Specification Version 1.2, erratum dated April 28, 2016, DCI, April 28, 2016.
https://www.dcinemovies.com/archives/spec_v1_2_With_Errata_Incorporated/index.html

DCI-NIST-NOTE

DCI Memorandum on NIST Standards Transitions and Non-FIPS Mode, DCI, July 1, 2020.
<https://www.dcinemovies.com/FIPS/>

OBAAE-ADD

Digital Cinema Object-Based Audio Addendum, DCI, October 1, 2018

DV-ADD

Direct View Display D-Cinema Addendum, DCI

DCI-HDR

High Dynamic Range D-Cinema Addendum, DCI

FIPS-140-2

FIPS 140-2: Security Requirements for Cryptographic Modules, NIST, December 12, 2002

FIPS-140-3

FIPS 140-3: Security Requirements for Cryptographic Modules, NIST, March 22, 2019

FIPS-180-2

FIPS 180-2: Secure Hash Standard, NIST, August 1, 2002

FIPS-197

FIPS 197: Advanced Encryption Standard (AES), NIST, November 26, 2001

FIPS-198a

FIPS 198a: The Keyed-Hash Message Authentication Code (HMAC), NIST, March 6, 2002

IEEE-802-3

802-3: Standard for Information technology—Telecommunications and information exchange between systems—Local and metropolitan area networks—Specific requirements Part 3: Carrier sense multiple access with collision detection (CSMA/CD) access method and physical layer specifications, IEEE, 2005

ISO-144496

ISO/IEC 144496: Information technology - Computer graphics and image processing - Font Compression and Streaming, ISO/IEC, 2004

ISO-15948

ISO-15948: Information technology - Computer graphics and image processing - Portable Network Graphics (PNG): Functional specification, ISO/IEC, 2004

ISO-15444-1

ISO/IEC 15444-1 2004, Information Technology: JPEG 2000 Image Coding System, ISO/IEC, 2004

ISO-15444-1-AMD-1

ISO/IEC 15444-1/Amd1:2006 Codestream restrictions - Amendment 1: Profiles for digital cinema applications, ISO/IEC, 2004

ISO-10646

ISO 10646: Information technology – Universal Multiple-Octet Coded Character Set (UCS), ISO/IEC, December 15, 2003

ITU-X509

ITU-T Recommendation X.509 (1997 E): Information Technology – Open Systems Interconnection – The Directory: Authentication Framework, ITU, June 1997

NIST-800-38A

NIST Special Publication 800-38A: Recommendation for Block Cipher Modes of Operation - Methods and Techniques, NIST, Morris Dworkin, December 2001

NIST-800-38F

NIST Special Publication 800-38F: Recommendation for Block Cipher Modes of Operation: Methods for Key Wrapping, NIST, December 2012

PKCS-1

PKCS #1 v2.1: RSA Cryptography Standard, RSA Laboratories, June 14, 2002

ICDM IDMS

Information Display Measurements Standard (IDMS), International Committee for Display Metrology (ICDM), Version 1.1a (March 2022)

RFC-1421

RFC 1421: "Privacy Enhancement for Internet Electronic Mail: Part I: Message Encryption and Authentication Procedures", IETF, J. Linn, February 1993

RFC-2045

RFC 2045: "Multipurpose Internet Mail Extensions (MIME) Part One: Format of Internet Message Bodies", IETF, N. Freed, N. Borenstein, November 1996

RFC-2246

RFC 2246: "The TLS Protocol Version 1.0", IETF, T. Dierks, C. Allen, January 1999

RFC-2246

RFC 5246: "The TLS Protocol Version 1.2", IETF, T. Dierks, E. Rescorla, August 2008

RFC-8446

RFC 8446: "The TLS Protocol Version 1.3", IETF, E. Rescorla, August 2018

RFC-2253

RFC 2253: "Lightweight Directory Access Protocol (v3): UTF-8 String Representation of Distinguished Names", IETF,

RFC-3174

RFC 3174: "US Secure Hash Algorithm 1 (SHA1)", IETF, September 2001

RFC-3339

RFC 3339: "Date and Time on the Internet: Timestamps", IETF, July 2002

RFC-3447

RFC 3447: "Public-Key Cryptography Standards (PKCS) #1: RSA Cryptography Specifications Version 2.1", IETF, J. Jonsson, B. Kaliski, February 2003

RFC-4122

RFC 4122: "A Universally Unique Identifier (UUID) URN Namespace", IETF, P. Leach, M. Mealling, July 2005

RFC-3268

RFC 3268: "Advanced Encryption Standard (AES) Ciphersuites for Transport Layer Security (TLS)", IETF, P. Chown, June 2002

SMPTE-330

SMPTE Standard for Television – Unique Material Identifier (UMID), SMPTE, 2011

SMPTE-336

SMPTE Standard for Television - Data Encoding Protocol using Key-Length-Value, SMPTE, 2007

SMPTE-372

Television - Dual Link 292M Interface for 1920 x 1080 Picture Raster, SMPTE, 2011

SMPTE-377-1

SMPTE Standard for Television – Material Exchange Format (MXF) – File Format Specification", SMPTE, 2011

SMPTE-379-1

SMPTE Standard for Television – Material Exchange Format (MXF) – MXF Generic Container, SMPTE, 2009

SMPTE-382

Material Exchange Format (MXF) – Mapping AES3 and Broadcast Wave Audio into the MXF Generic Container, SMPTE, 2007

SMPTE-390

Television - Material Exchange Format (MXF) - Specialized Operational Pattern "Atom" (Simplified Representation of a Single Item), SMPTE, 2011

SMPTE-410

Material Exchange Format - Generic Stream Partition, SMPTE, 2008

SMPTE-422

Material Exchange Format - Mapping JPEG 2000 Codestreams into the MXF Generic Container, SMPTE, 2006

SMPTE-428-1

D-Cinema Distribution Master - Image Structure, SMPTE, 2006

SMPTE-428-2

D-Cinema Distribution Master- Audio Characteristics, SMPTE, 2006

SMPTE-428-3

D-Cinema Distribution Master - Audio Channel Mapping, SMPTE, 2006

SMPTE-428-7

D-Cinema Distribution Master - Subtitle, SMPTE, 2010

SMPTE-428-10

D-Cinema Distribution Master - Closed Caption and Closed Subtitle, SMPTE, 2008

SMPTE-428-12

D-Cinema Distribution Master - Common Audio Channels and Soundfield Groups, SMPTE, 2013

SMPTE-429-2

D-Cinema Packaging - Operational Constraints, SMPTE, 2011

SMPTE-429-3

D-Cinema Packaging - Sound and Picture Track File Application, SMPTE, 2007

SMPTE-429-4

D-Cinema Packaging - MXF JPEG2000 Application, SMPTE, 2006

SMPTE-429-5

D-Cinema Packaging - Subtitling Distribution Format, SMPTE, 2009

SMPTE-429-6

D-Cinema Packaging - Track File Essence Encryption, SMPTE, 2006

SMPTE-429-7

D-Cinema Packaging - Composition Playlist Application, SMPTE, 2006

SMPTE-429-8

D-Cinema Packaging - Packing List, SMPTE, 2007

SMPTE-429-9

D-Cinema Packaging - Asset Mapping, SMPTE, 2007

SMPTE-429-10

- D-Cinema Packaging - Stereoscopic Picture Track File*, SMPTE, 2008
- SMPTE-429-12**
D-Cinema Packaging - Caption and Closed Subtitle, SMPTE, 2008
- SMPTE-429-14**
D-Cinema Packaging - Aux Data Track File, SMPTE, 2014
- SMPTE-429-16**
D-Cinema Packaging - Additional Composition Metadata and Guidelines, SMPTE, 2014
- SMPTE-429-18**
D-Cinema Packaging - Immersive Audio Track File, SMPTE, 2019
- SMPTE-429-19**
D-Cinema Packaging - DCP Operational Constraints for Immersive Audio, SMPTE, 2019
- SMPTE-430-1**
D-Cinema Operations - Key Delivery Message, SMPTE, 2017, incorporating Amendment 1, 2019
- SMPTE-430-2**
D-Cinema Operations - Digital Certificate, SMPTE, 2006
- SMPTE-430-3**
D-Cinema Operations - Generic Extra-Theatre Message Format, SMPTE, 2008
- SMPTE-430-4**
D-Cinema Operations - Log Records Format, SMPTE, 2008
- SMPTE-430-5**
D-Cinema Operations - Security Log Event Class and Constraints, SMPTE, 2011
- SMPTE-430-12**
D-Cinema Operations – FSK Synchronization Signal, SMPTE, 2014, incorporating Amendment 1, 2019
- SMPTE-431-1**
D-Cinema Quality - Screen Luminance Level, Chromaticity, and Uniformity, SMPTE, 2006
- SMPTE-431-2**
D-Cinema Quality - Reference Projector and Environment, SMPTE, 2011
- SMPTE-432-1**
Digital Source Processing - Color Processing for D-Cinema, SMPTE, 2010
- SMPTE-432-2**
Digital Source Processing - D-Cinema Low Frequency Effects (LFE) Channel Audio Characteristics, SMPTE, 2006
- SMPTE-433**
D-Cinema - XML Data Types, SMPTE, 2008
- SMPTE-rdd-20**
D-Cinema - CineLink 2 link encryption protocol, SMPTE, 2010
- SMPTE-2098-2**
Immersive Audio Bitstream Specification, SMPTE, 2019
- SMPTE-2098-3**
Immersive Audio Renderer Expectations and Testing Recommendations, SMPTE, 2020
- SMPTE-2098-5**
D-Cinema Immersive Audio Channels and Soundfield, SMPTE, 2018

APPENDIX G. DIGITAL CINEMA SYSTEM SPECIFICATION REFERENCES TO CTP

DCSS Section	CTP Procedure Title	CTP Section
2.1.1.4	<u>Decoder Requirements</u>	6.5.2.
3.2.1	<u>Image Frame Rates</u>	7.5.33.
3.2.1.2	<u>Image Structure Container and Image Container Format</u>	4.5.1.
3.2.1.3	<u>Image Structure Container and Image Container Format</u>	4.5.1.
3.2.1.5	<u>Image Compression Standard & Encoding Parameters</u>	4.5.2.
3.2.1.7	<u>Image Structure Container and Image Container Format</u>	4.5.1.
3.3	<u>Constrained OMB Processing Capability</u>	10.4.81.
3.3.2.1	<u>Audio Sample Rate Conversion</u>	6.6.2.
3.3.2.2	<u>Audio Characteristics</u>	4.5.3.
3.3.4	<u>Timed Text Track File Format</u>	4.4.3.
3.3.4.1	<u>Audio Characteristics</u>	4.5.3.
3.3.4.3	<u>Maximum Bitrate OBAE</u>	6.8.3.
3.4.2.2	<u>Timed Text Resource Encoding</u>	4.5.4.
3.4.3	<u>Default Timed Text Font</u>	6.7.4.
3.4.3.4	<u>Timed Text Resource Encoding</u>	4.5.4.
4.2	<u>Image Compression Standard & Encoding Parameters</u>	4.5.2.
4.3.2	<u>Decoder Requirements</u>	6.5.2.
4.4	<u>Image Compression Standard & Encoding Parameters</u>	4.5.2.
4.4.3.2	<u>Timed Text Resource Encoding</u>	4.5.4.
5.2.2.2	<u>Image and Audio Packaging Standard</u>	4.4.2.
5.2.2.3	<u>Image and Audio Packaging Standard</u>	4.4.2.
5.2.2.4	<u>Image and Audio Packaging Standard</u>	4.4.2.
5.2.2.5	<u>Image and Audio Packaging Standard</u>	4.4.2.
5.2.2.6	<u>Image and Audio Packaging Standard</u>	4.4.2.
5.2.2.6	<u>DCP Integrity</u>	4.6.1.
5.2.3	<u>Composition Playlist File</u>	4.3.1.
5.2.3	<u>Composition Playlist Signature Validation</u>	4.3.2.
5.3.1	<u>Image and Audio Packaging Standard</u>	4.4.2.
5.3.1.3	<u>Track File Length</u>	4.4.4.
5.3.1.3	<u>Playback of Image Only Material</u>	6.5.1.
5.3.1.6	<u>Click Free Splicing of Audio Track Files</u>	6.6.4.
5.3.1.6	<u>Click Free Splicing of OBAE Track Files</u>	6.8.1.
5.3.1.7	<u>Composition Playlist Key Usage</u>	4.3.3.

5.3.2	<u>Image and Audio Packaging Standard</u>	4.4.2.
5.3.3.2	<u>Image Track File Frame Boundary</u>	4.4.5.
5.3.4.2	<u>Audio Track File Frame Boundary</u>	4.4.6.
5.3.4.5	<u>Maximum Bitrate OBAE</u>	6.8.3.
5.4.2	<u>Composition Playlist File</u>	4.3.1.
5.4.3	<u>Composition Playlist File</u>	4.3.1.
5.4.3.2	<u>Composition Playlist File</u>	4.3.1.
5.4.3.3	<u>Composition Playlist File</u>	4.3.1.
5.4.3.4	<u>Composition Playlist File</u>	4.3.1.
5.4.3.6	<u>Composition Playlist Signature Validation</u>	4.3.2.
5.4.4	<u>Composition Playlist Signature Validation</u>	4.3.2.
5.5.2.1	<u>Asset Map File</u>	4.1.1.
5.5.2.1	<u>Volume Index File</u>	4.1.2.
5.5.2.3	<u>Packing List Signature Validation</u>	4.2.2.
5.5.2.3	<u>DCP Integrity</u>	4.6.1.
5.5.3.1	<u>Packing List File</u>	4.2.1.
5.5.3.2	<u>Packing List File</u>	4.2.1.
5.5.3.2	<u>Packing List Signature Validation</u>	4.2.2.
5.5.3.2	<u>DCP Integrity</u>	4.6.1.
6.2.3	<u>Storage System Ingest Interface</u>	8.1.1.
7.2.3.1	<u>Theater System Reliability</u>	10.4.1.
7.2.3.2	<u>Theater System Reliability</u>	10.4.1.
7.2.3.5	<u>Show Playlist Creation</u>	8.2.2.
7.2.3.5	<u>Show Playlist Creation (OBAE)</u>	8.2.18.
7.2.3.7	<u>Show Playlist Creation</u>	8.2.2.
7.2.3.7	<u>Show Playlist Creation (OBAE)</u>	8.2.18.
7.2.3.11	<u>Storage System Capacity</u>	8.1.2.
7.2.3.13	<u>Restarting Playback</u>	8.2.8.
7.2.3.13	<u>Restarting Playback (OBAE)</u>	8.2.17.
7.3	<u>Show Playlist Format</u>	8.2.3.
7.3.4	<u>Show Playlist Creation</u>	8.2.2.
7.3.4	<u>Automation Control and Interfaces</u>	8.2.5.
7.3.4	<u>Show Playlist Creation (OBAE)</u>	8.2.18.
7.4.1.1	<u>Show Playlist Creation</u>	8.2.2.
7.4.1.1	<u>Show Playlist Creation (OBAE)</u>	8.2.18.
7.4.1.2	<u>Show Playlist Creation</u>	8.2.2.
7.4.1.2	<u>Restarting Playback</u>	8.2.8.
7.4.1.2	<u>Restarting Playback (OBAE)</u>	8.2.17.
7.4.1.2	<u>Show Playlist Creation (OBAE)</u>	8.2.18.

7.4.1.3	<u>SMS User Accounts</u>	8.2.9.
7.4.1.3	<u>Show Playlist Creation (OBAE)</u>	8.2.18.
7.4.1.4	<u>Show Playlist Creation</u>	8.2.2.
7.4.1.4	<u>Show Playlist Creation (OBAE)</u>	8.2.18.
7.4.1.5	<u>Show Playlist Creation</u>	8.2.2.
7.4.1.5	<u>Show Playlist Creation (OBAE)</u>	8.2.18.
7.4.1.6	<u>Show Playlist Creation</u>	8.2.2.
7.4.1.6	<u>Show Playlist Format</u>	8.2.3.
7.4.1.6	<u>Automation Control and Interfaces</u>	8.2.5.
7.4.1.6	<u>Artifact Free Transition of Image Format</u>	8.2.7.
7.4.1.6	<u>Show Playlist Creation (OBAE)</u>	8.2.18.
7.4.1.7	<u>Automation Control and Interfaces</u>	8.2.5.
7.4.1.8	<u>Audio Delay Setup</u>	6.6.3.
7.4.1.8	<u>OBAE Delay Setup</u>	6.8.2.
7.4.1.8	<u>Interrupt Free Playback</u>	8.2.6.
7.4.1.8	<u>Restarting Playback</u>	8.2.8.
7.4.1.8	<u>Interrupt Free Playback (OBAE)</u>	8.2.16.
7.4.1.8	<u>Restarting Playback (OBAE)</u>	8.2.17.
7.5.3.2	<u>Storage System Redundancy</u>	8.1.3.
7.5.3.3	<u>Storage System Performance</u>	8.1.4.
7.5.3.3	<u>Storage System Performance (OBAE)</u>	8.1.6.
7.5.3.4	<u>Storage System Performance</u>	8.1.4.
7.5.3.4	<u>Storage System Performance (OBAE)</u>	8.1.6.
7.5.3.6	<u>Storage System Performance</u>	8.1.4.
7.5.3.6	<u>Storage System Performance (OBAE)</u>	8.1.6.
7.5.3.8	<u>Theater System Storage Security</u>	10.4.2.
7.5.4.2.5	<u>Media Block Overlay</u>	6.7.1.
7.5.4.2.6	<u>Media Block Overlay</u>	6.7.1.
7.5.4.2.7	<u>Media Block Overlay</u>	6.7.1.
7.5.4.3	<u>Digital Audio Interfaces</u>	6.6.1.
7.5.6.1	<u>Digital Audio Interfaces</u>	6.6.1.
7.5.6.1	<u>OBAE Rendering Expectations</u>	6.8.4.
7.5.6.2	<u>Digital Audio Interfaces</u>	6.6.1.
7.5.7.2	<u>Automation Control and Interfaces</u>	8.2.5.
8.2.2.6	<u>Imaging Device Pixel Count/Structure</u>	7.5.3.
8.2.2.7	<u>Imaging Device Pixel Count/Structure</u>	7.5.3.
8.2.2.9	<u>FM Insertion Requirements</u>	10.4.43.
8.3.3	<u>SDR Contouring</u>	7.5.10.
8.3.3	<u>SDR Color Accuracy</u>	7.5.12.

8.3.3	<u>HDR Contouring</u>	7.5.35.
8.3.4.3	<u>SDR White Luminance and Chromaticity</u>	7.5.15.
8.3.4.4	<u>SDR White Luminance and Chromaticity</u>	7.5.15.
8.3.4.8	<u>SDR Intra-frame Contrast</u>	7.5.8.
8.3.4.9	<u>Grayscale Tracking</u>	7.5.9.
9.1	<u>Constrained OMB Processing Capability</u>	10.4.81.
9.3.3.2	<u>Security Entity Physical Protection</u>	10.4.4.
9.3.4.11	<u>SDR Transfer Function</u>	7.5.11.
9.4.1	<u>Theater System Storage Security</u>	10.4.2.
9.4.1.1	<u>SMS Operator Identification</u>	8.2.10.
9.4.1.1	<u>SMS Operator Identification (OBAE)</u>	8.2.20.
9.4.1.1	<u>Security Entity Physical Protection</u>	10.4.4.
9.4.1.1	<u>Secure SMS-SM Communication</u>	10.4.5.
9.4.2.2	<u>Projector and Direct View Display Physical Protection</u>	7.2.1.
9.4.2.4	<u>SM Operating Environment</u>	9.5.1.
9.4.2.4	<u>Location of Security Manager</u>	10.4.6.
9.4.2.5	<u>SMS Identity and Certificate</u>	8.2.11.
9.4.2.5	<u>Validity of SMS Certificates</u>	8.2.15.
9.4.2.5	<u>Self-initiated cryptographic output capability</u>	9.5.14.
9.4.2.5	<u>Self-initiated cryptographic output capability</u>	9.5.14.
9.4.2.5	<u>Secure SMS-SM Communication</u>	10.4.5.
9.4.2.5	<u>TLS Authentication of Dual Certificate SM</u>	10.4.80.
9.4.2.7	<u>Constrained OMB Processing Capability</u>	10.4.81.
9.4.3.2	<u>Content Keys and TDL check</u>	8.2.12.
9.4.3.2	<u>Content Keys and TDL check (OBAE)</u>	8.2.13.
9.4.3.5	<u>KDM NonCriticalExtensions Element</u>	3.5.1.
9.4.3.5	<u>ETM IssueDate Field Check</u>	3.5.2.
9.4.3.5	<u>Structure ID Check</u>	3.5.4.
9.4.3.5	<u>Certificate Thumbprint Check</u>	3.5.5.
9.4.3.5	<u>KeyInfo Field Check</u>	3.5.7.
9.4.3.5	<u>KDM Malformations</u>	3.5.8.
9.4.3.5	<u>KDM Signature</u>	3.5.9.
9.4.3.5	<u>KDM NonCriticalExtensions Element (OBAE)</u>	3.5.10.
9.4.3.5	<u>ETM IssueDate Field Check (OBAE)</u>	3.5.11.
9.4.3.5	<u>Structure ID Check (OBAE)</u>	3.5.12.
9.4.3.5	<u>Certificate Thumbprint Check (OBAE)</u>	3.5.13.
9.4.3.5	<u>KeyInfo Field Check (OBAE)</u>	3.5.14.
9.4.3.5	<u>KDM Malformations (OBAE)</u>	3.5.15.
9.4.3.5	<u>KDM Signature (OBAE)</u>	3.5.16.

9.4.3.5	<u>Sound Integrity Checking</u>	6.1.2.
9.4.3.5	<u>Restriction of Keying to MD Type</u>	6.1.4.
9.4.3.5	<u>Restriction of Keying to Valid CPLs</u>	6.1.5.
9.4.3.5	<u>Content Key Extension, End of Engagement</u>	6.1.8.
9.4.3.5	<u>ContentAuthenticator Element Check</u>	6.1.9.
9.4.3.5	<u>KDM TDL Check</u>	6.1.11.
9.4.3.5	<u>CPL Id Check</u>	6.1.13.
9.4.3.5	<u>CPL Id Check (OBAE)</u>	6.1.14.
9.4.3.5	<u>Restriction of Playback in Absence of Integrity Pack Metadata</u>	6.1.15.
9.4.3.5	<u>Restriction of Keying to MDEK Type (OBAE)</u>	6.1.16.
9.4.3.5	<u>OBAE Integrity Checking</u>	6.1.17.
9.4.3.5	<u>Content Key Extension, End of Engagement (OBAE)</u>	6.1.18.
9.4.3.5	<u>Restriction of Keying to Valid CPLs (OBAE)</u>	6.1.22.
9.4.3.5	<u>ContentAuthenticator Element Check (OBAE)</u>	6.1.23.
9.4.3.5	<u>Timed Text Decryption</u>	6.7.6.
9.4.3.5	<u>KDM Content Keys Check</u>	8.2.14.
9.4.3.5	<u>Location of Security Manager</u>	10.4.6.
9.4.3.5	<u>KDM Purge upon Expiry</u>	10.4.16.
9.4.3.5(9d)	<u>Export of KDM-Borne Keys</u>	10.4.82.
9.4.3.6.1	<u>KDM TDL Check</u>	6.1.11.
9.4.3.6.1	<u>Projector and Direct View Display Physical Protection</u>	7.2.1.
9.4.3.6.1	<u>Projector and Direct View Display Security Servicing</u>	7.2.2.
9.4.3.6.1	<u>Electronic Marriage Break Key Retaining</u>	7.2.8.
9.4.3.6.1	<u>Companion SPBs with Electronic Marriage</u>	7.3.2.
9.4.3.6.1	<u>Imaging Device Secure Silicon Device</u>	10.4.18.
9.4.3.6.1	<u>Access to Imaging Device Image Signals</u>	10.4.19.
9.4.3.6.1	<u>Systems with Electronic Marriage</u>	10.4.20.
9.4.3.6.1	<u>Imaging Device SPB Log Reporting Requirements</u>	10.4.78.
9.4.3.6.3	<u>Timed Text Decryption</u>	6.7.6.
9.4.3.6.3	<u>Companion SPBs with Electronic Marriage</u>	7.3.2.
9.4.3.6.3	<u>Companion SPB Marriage Break Key Retaining</u>	7.3.3.
9.4.3.6.3	<u>SPB Type 1 Tamper Responsiveness</u>	9.5.3.
9.4.3.6.3	<u>MB Tasks</u>	10.4.58.
9.4.3.6.3	<u>SPB Type 1 Log Retention</u>	10.4.69.
9.4.3.6.3	<u>Log Collection for Married MB</u>	10.4.75.
9.4.3.6.3	<u>Companion SPB Single Purpose Requirement</u>	10.4.76.
9.4.3.6.3(5)	<u>Constrained OMB Processing Capability</u>	10.4.81.
9.4.3.6.4	<u>Restriction of Playback in Absence of Integrity Pack Metadata</u>	6.1.15.
9.4.3.6.4	<u>Restriction of Keying to MDEK Type (OBAE)</u>	6.1.16.

9.4.3.6.4	<u>KDM Content Keys Check</u>	8.2.14.
9.4.3.6.4	<u>MB Tasks</u>	10.4.58.
9.4.3.6.4	<u>Constrained OMB Processing Capability</u>	10.4.81.
9.4.3.6.5	<u>KDM TDL Check</u>	6.1.11.
9.4.3.6.5	<u>Companion SPB Retrieve Imaging Device Cert</u>	10.4.74.
9.4.3.6.6	<u>KDM TDL Check</u>	6.1.11.
9.4.3.6.6	<u>Systems without Electronic Marriage</u>	7.2.7.
9.4.3.6.6	<u>Systems Without Electronic Marriage</u>	10.4.21.
9.4.3.7	<u>Clock Adjustment</u>	6.3.1.
9.4.3.7	<u>SPB Type 1 Clock Battery</u>	6.3.2.
9.4.3.7	<u>Clock Resolution</u>	6.3.3.
9.4.3.7	<u>Clock Resolution (OMB)</u>	6.3.4.
9.4.3.7	<u>Clock Adjustment (OMB)</u>	6.3.5.
9.4.3.7	<u>Clock Date-Time-Range</u>	10.4.22.
9.4.3.7	<u>Clock Setup</u>	10.4.23.
9.4.3.7	<u>Clock Stability</u>	10.4.24.
9.4.3.7	<u>Clock Continuity</u>	10.4.27.
9.4.3.7	<u>SPB Type 1 Battery Life</u>	10.4.73.
9.4.6.1.1	<u>FM Payload</u>	6.4.3.
9.4.6.1.1	<u>FM Payload (OBAE)</u>	6.4.8.
9.4.6.1.1	<u>FM Algorithm General Requirements</u>	10.4.42.
9.4.6.1.1	<u>FM Insertion Requirements</u>	10.4.43.
9.4.6.1.2	<u>IFM Visual Transparency</u>	10.4.44.
9.4.6.1.2	<u>IFM Robustness</u>	10.4.45.
9.4.6.1.3	<u>AFM Inaudibility</u>	10.4.46.
9.4.6.1.3	<u>AFM Robustness</u>	10.4.47.
9.4.6.1.3	<u>OBAE FM Robustness</u>	10.4.85.
9.4.6.1.3	<u>OBAE FM Inaudibility</u>	10.4.86.
9.4.6.2	<u>FM Application Constraints</u>	6.4.1.
9.4.6.2	<u>Granularity of FM Control</u>	6.4.2.
9.4.6.2	<u>FM Audio Bypass</u>	6.4.4.
9.4.6.2	<u>Selective Audio FM Control</u>	6.4.5.
9.4.6.2	<u>FM Application Constraints (OBAE)</u>	6.4.6.
9.4.6.2	<u>Granularity of FM Control (OBAE)</u>	6.4.7.
9.4.6.2	<u>FM Audio Bypass (OBAE)</u>	6.4.9.
9.4.6.2	<u>FM Control Instance</u>	10.4.48.
9.4.6.2(9)	<u>FM Insertion Requirements</u>	10.4.43.
9.4.6.3.1	<u>Log Sequence Numbers</u>	5.3.2.3.
9.4.6.3.1	<u>Log Report Signature Validity</u>	5.3.2.6.

9.4.6.3.1	<u>Log Report Signature Validity (OBAE)</u>	5.3.2.8.
9.4.6.3.1	<u>SPB Log Storage Requirements</u>	10.4.51.
9.4.6.3.1	<u>MB Log Storage Capabilities</u>	10.4.53.
9.4.6.3.2	<u>Log Structure</u>	5.3.2.1.
9.4.6.3.3	<u>Log Report Signature Validity</u>	5.3.2.6.
9.4.6.3.3	<u>Log Report Signature Validity (OBAE)</u>	5.3.2.8.
9.4.6.3.4	<u>Log Sequence Numbers</u>	5.3.2.3.
9.4.6.3.4	<u>Log Sequence Numbers (OBAE)</u>	5.3.2.7.
9.4.6.3.7	<u>Log Report Signature Validity</u>	5.3.2.6.
9.4.6.3.7	<u>Log Report Signature Validity (OBAE)</u>	5.3.2.8.
9.4.6.3.7	<u>FrameSequencePlayed Event</u>	5.4.1.1.
9.4.6.3.7	<u>CPLStart Event</u>	5.4.1.2.
9.4.6.3.7	<u>CPLEnd Event</u>	5.4.1.3.
9.4.6.3.7	<u>PlayoutComplete Event</u>	5.4.1.4.
9.4.6.3.7	<u>CPLCheck Event</u>	5.4.1.5.
9.4.6.3.7	<u>KDMKeysReceived Event</u>	5.4.1.6.
9.4.6.3.7	<u>KDMDeleted Event</u>	5.4.1.7.
9.4.6.3.7	<u>FrameSequencePlayed Event (OBAE)</u>	5.4.1.8.
9.4.6.3.7	<u>CPLStart Event (OBAE)</u>	5.4.1.9.
9.4.6.3.7	<u>CPLEnd Event (OBAE)</u>	5.4.1.10.
9.4.6.3.7	<u>PlayoutComplete Event (OBAE)</u>	5.4.1.11.
9.4.6.3.7	<u>CPLCheck Event (OBAE)</u>	5.4.1.12.
9.4.6.3.7	<u>KDMKeysReceived Event (OBAE)</u>	5.4.1.13.
9.4.6.3.7	<u>KDMDeleted Event (OBAE)</u>	5.4.1.14.
9.4.6.3.7	<u>SPBStartup and SPBShutdown Events</u>	5.4.2.6.
9.4.6.3.7	<u>SPBOpen and SPBClose Events</u>	5.4.2.7.
9.4.6.3.7	<u>SPBClockAdjust Event</u>	5.4.2.8.
9.4.6.3.7	<u>SPBMarriage and SPBDivorce Events</u>	5.4.2.9.
9.4.6.3.7	<u>SPBSoftware Event</u>	5.4.2.10.
9.4.6.3.7	<u>SPBSecurityAlert Event</u>	5.4.2.11.
9.4.6.3.8	<u>KDM Malformations</u>	3.5.8.
9.4.6.3.8	<u>KDM Malformations (OBAE)</u>	3.5.15.
9.4.6.3.8	<u>FrameSequencePlayed Event</u>	5.4.1.1.
9.4.6.3.8	<u>CPLStart Event</u>	5.4.1.2.
9.4.6.3.8	<u>CPLEnd Event</u>	5.4.1.3.
9.4.6.3.8	<u>PlayoutComplete Event</u>	5.4.1.4.
9.4.6.3.8	<u>CPLCheck Event</u>	5.4.1.5.
9.4.6.3.8	<u>KDMKeysReceived Event</u>	5.4.1.6.
9.4.6.3.8	<u>KDMDeleted Event</u>	5.4.1.7.

9.4.6.3.8	<u>CPLStart Event (OBAE)</u>	5.4.1.9.
9.4.6.3.8	<u>CPEnd Event (OBAE)</u>	5.4.1.10.
9.4.6.3.8	<u>PlayoutComplete Event (OBAE)</u>	5.4.1.11.
9.4.6.3.8	<u>CPLCheck Event (OBAE)</u>	5.4.1.12.
9.4.6.3.8	<u>KDMKeysReceived Event (OBAE)</u>	5.4.1.13.
9.4.6.3.8	<u>KDMDeleted Event (OBAE)</u>	5.4.1.14.
9.4.6.3.8	<u>SPBStartup and SPBShutdown Events</u>	5.4.2.6.
9.4.6.3.8	<u>SPBOpen and SPBClose Events</u>	5.4.2.7.
9.4.6.3.8	<u>SPBClockAdjust Event</u>	5.4.2.8.
9.4.6.3.8	<u>SPBMarriage and SPBDivorce Events</u>	5.4.2.9.
9.4.6.3.8	<u>SPBSoftware Event</u>	5.4.2.10.
9.4.6.3.8	<u>SPBSecurityAlert Event</u>	5.4.2.11.
9.4.6.3.8	<u>SPBSecurityAlert Event</u>	5.4.2.11.
9.4.6.3.8	<u>FM Application Constraints (OBAE)</u>	6.4.6.
9.4.6.3.8	<u>Granularity of FM Control (OBAE)</u>	6.4.7.
9.4.6.3.8	<u>Imaging Device SPB Log Reporting Requirements</u>	10.4.78.
9.4.6.3.10	<u>SPB Log Failure</u>	10.4.56.
9.4.6.3.10	<u>Log Purging in Failed SPBs</u>	10.4.57.
9.4.6.3.10	<u>SPB Type 1 Log Retention</u>	10.4.69.
9.5.1	<u>Basic Certificate Structure</u>	2.1.1.
9.5.1	<u>SignatureAlgorithm Fields</u>	2.1.2.
9.5.1	<u>SignatureValue Field</u>	2.1.3.
9.5.1	<u>SerialNumber Field</u>	2.1.4.
9.5.1	<u>SubjectPublicKeyInfo Field</u>	2.1.5.
9.5.1	<u>Validity Field</u>	2.1.7.
9.5.1	<u>AuthorityKeyIdentifier Field</u>	2.1.8.
9.5.1	<u>KeyUsage Field</u>	2.1.9.
9.5.1	<u>Basic Constraints Field</u>	2.1.10.
9.5.1	<u>Public Key Thumbprint</u>	2.1.11.
9.5.1	<u>Organization Name Field</u>	2.1.12.
9.5.1	<u>Entity Name and Roles Field</u>	2.1.14.
9.5.1	<u>Unrecognized Extensions</u>	2.1.15.
9.5.1	<u>Signature Validation</u>	2.1.16.
9.5.1	<u>Certificate Chains</u>	2.1.17.
9.5.1	<u>ASN.1 DER Encoding Check</u>	2.2.1.
9.5.1	<u>Missing Required Fields</u>	2.2.2.
9.5.1	<u>PathLen Check</u>	2.2.3.
9.5.1	<u>OrganizationName Match Check</u>	2.2.4.
9.5.1	<u>Certificate Role Check</u>	2.2.5.

9.5.1	<u>Signature Algorithm Check</u>	2.2.7.
9.5.1	<u>Public Key Type Check</u>	2.2.8.
9.5.1	<u>Issuer Certificate Presence Check</u>	2.2.9.
9.5.1	<u>SPB Digital Certificate</u>	5.1.1.
9.5.1	<u>Validity of SPB Certificates</u>	6.1.20.
9.5.1	<u>SMS Identity and Certificate</u>	8.2.11.
9.5.1	<u>Validity of SMS Certificates</u>	8.2.15.
9.5.1	<u>Type 1 SPB RSA Private Keys</u>	10.4.59.
9.5.1	<u>Content Keys Outside Secure Silicon</u>	10.4.60.
9.5.1	<u>TLS Authentication of Dual Certificate SM</u>	10.4.80.
9.5.1.1	<u>KeyUsage Field</u>	2.1.9.
9.5.1.1	<u>SPB Digital Certificate</u>	5.1.1.
9.5.1.1	<u>Log Report Signature Validity</u>	5.3.2.6.
9.5.1.1	<u>Log Report Signature Validity (OBAE)</u>	5.3.2.8.
9.5.1.1	<u>Systems Without Electronic Marriage</u>	10.4.21.
9.5.1.2	<u>KeyUsage Field</u>	2.1.9.
9.5.1.2	<u>SPB Digital Certificate</u>	5.1.1.
9.5.1.2	<u>Log Report Signature Validity</u>	5.3.2.6.
9.5.1.2	<u>Log Report Signature Validity (OBAE)</u>	5.3.2.8.
9.5.1.2	<u>Companion SPB Marriage Break Key Retaining</u>	7.3.3.
9.5.1.2	<u>Systems Without Electronic Marriage</u>	10.4.21.
9.5.1.2	<u>TLS Authentication of Dual Certificate SM</u>	10.4.80.
9.5.1.3	<u>SPB Digital Certificate</u>	5.1.1.
9.5.1.3	<u>Plurality of Media Block Identity Certificates</u>	6.1.19.
9.5.2.2	<u>Projector and Direct View Display Physical Protection</u>	7.2.1.
9.5.2.2	<u>SPB Type 1 Tamper Responsiveness</u>	9.5.3.
9.5.2.2	<u>Type 1 SPB RSA Private Keys</u>	10.4.59.
9.5.2.2	<u>Content Keys Outside Secure Silicon</u>	10.4.60.
9.5.2.2	<u>Use of Software Protection Methods</u>	10.4.62.
9.5.2.2	<u>SPB Secure Silicon Requirements</u>	10.4.72.
9.5.2.3	<u>SPB2 Secure Silicon Field Replacement</u>	7.2.6.
9.5.2.3	<u>Repair and Renewal of SPBs</u>	10.4.25.
9.5.2.3	<u>Prohibition of SPB Type 1 Field Serviceability</u>	10.4.61.
9.5.2.4	<u>Projector and Direct View Display Physical Protection</u>	7.2.1.
9.5.2.4	<u>Projector and Direct View Display Security Servicing</u>	7.2.2.
9.5.2.4	<u>SPB2 Protected Devices</u>	10.4.26.
9.5.2.4.1	<u>Projector and Direct View Display Physical Protection</u>	7.2.1.
9.5.2.4.1	<u>Projector and Direct View Display Security Servicing</u>	7.2.2.
9.5.2.5	<u>SM Operating Environment</u>	9.5.1.

9.5.2.5	<u>SPB Type 1 FIPS Requirements</u>	9.5.6.
9.5.2.5	<u>Asymmetric Key Generation</u>	9.5.8.
9.5.2.5	<u>Critical Security Parameter Protection</u>	9.5.9.
9.5.2.5	<u>TMS Role</u>	10.4.63.
9.5.2.5.1	<u>Degraded mode(s) of operation prohibited</u>	9.5.11.
9.5.2.5.1	<u>Control output inhibition</u>	9.5.12.
9.5.2.5.1	<u>Maintenance role/interface prohibited</u>	9.5.13.
9.5.2.5.1	<u>Self-initiated cryptographic output capability</u>	9.5.14.
9.5.2.5.1	<u>Self-initiated cryptographic output capability</u>	9.5.15.
9.5.2.5.1	<u>Periodic self-tests</u>	9.5.16.
9.5.2.6	<u>SPB Type 1 Tamper Responsiveness</u>	9.5.3.
9.5.2.6	<u>Critical Security Parameter Protection</u>	9.5.9.
9.5.2.6	<u>D-Cinema Security Parameter Protection</u>	10.4.64.
9.5.2.7	<u>SM Operating Environment</u>	9.5.1.
9.5.2.7	<u>SPB Type 1 Firmware Modifications</u>	10.4.68.
9.6.1	<u>Location of Security Manager</u>	10.4.6.
9.6.1.2	<u>Location of Security Manager</u>	10.4.6.
9.7.2	<u>Timed Text Decryption</u>	6.7.6.
9.7.4	<u>Content Keys Outside Secure Silicon</u>	10.4.60.
9.7.5	<u>Composition Playlist Signature Validation</u>	4.3.2.
9.7.5	<u>DCP Integrity</u>	4.6.1.
9.7.6	<u>Asymmetric Key Generation</u>	9.5.8.
9.7.6	<u>RSA Key Entropy</u>	10.4.65.
9.7.6	<u>Preloaded Symmetric Key Entropy</u>	10.4.66.
9.7.7	<u>Composition Playlist File</u>	4.3.1.
9.7.7	<u>Maximum Number of DCP Keys</u>	6.1.12.
9.7.7	<u>Maximum Number of DCP Keys (OBAE)</u>	6.1.21.
9.7.7	<u>Media Block Caching of Keys</u>	10.4.67.
9.8	<u>Basic Certificate Structure</u>	2.1.1.
9.8	<u>SignatureAlgorithm Fields</u>	2.1.2.
9.8	<u>SignatureValue Field</u>	2.1.3.
9.8	<u>SerialNumber Field</u>	2.1.4.
9.8	<u>SubjectPublicKeyInfo Field</u>	2.1.5.
9.8	<u>Validity Field</u>	2.1.7.
9.8	<u>AuthorityKeyIdentifier Field</u>	2.1.8.
9.8	<u>KeyUsage Field</u>	2.1.9.
9.8	<u>Basic Constraints Field</u>	2.1.10.
9.8	<u>Public Key Thumbprint</u>	2.1.11.
9.8	<u>Organization Name Field</u>	2.1.12.

9.8	<u>Entity Name and Roles Field</u>	2.1.14.
9.8	<u>Unrecognized Extensions</u>	2.1.15.
9.8	<u>Signature Validation</u>	2.1.16.
9.8	<u>Certificate Chains</u>	2.1.17.
9.8	<u>ASN.1 DER Encoding Check</u>	2.2.1.
9.8	<u>Missing Required Fields</u>	2.2.2.
9.8	<u>PathLen Check</u>	2.2.3.
9.8	<u>OrganizationName Match Check</u>	2.2.4.
9.8	<u>Certificate Role Check</u>	2.2.5.
9.8	<u>Validity Date Check</u>	2.2.6.
9.8	<u>Signature Algorithm Check</u>	2.2.7.
9.8	<u>Public Key Type Check</u>	2.2.8.
9.8	<u>Issuer Certificate Presence Check</u>	2.2.9.
9.8	<u>ETM Structure</u>	3.3.1.
9.8	<u>ETM Validity Date Check</u>	3.3.2.
9.8	<u>ETM Signer Element</u>	3.3.3.
9.8	<u>ETM EncryptionMethod Element</u>	3.3.4.
9.8	<u>KDM MessageType Element</u>	3.4.1.
9.8	<u>KDM SubjectName Element</u>	3.4.2.
9.8	<u>KDM ContentAuthenticator Element</u>	3.4.3.
9.8	<u>KDM KeyIdList/TypedKeyId Field</u>	3.4.5.
9.8	<u>KDM EncryptedData Element</u>	3.4.7.
9.8	<u>KDM KeyInfo Element</u>	3.4.8.
9.8	<u>KDM DeviceListDescription Element</u>	3.4.9.
9.8	<u>KDM CompositionPlaylistId Element</u>	3.4.13.
9.8	<u>KDM Validity Fields</u>	3.4.14.
9.8	<u>KDM KeyIdList Element</u>	3.4.15.
9.8	<u>KDM CipherData Structure ID</u>	3.4.16.
9.8	<u>KDM CipherData Signer Thumbprint</u>	3.4.17.
9.8	<u>KDM CipherData Validity</u>	3.4.18.
9.8	<u>KDM CipherData CPL ID</u>	3.4.19.
9.8	<u>KDM NonCriticalExtensions Element</u>	3.5.1.
9.8	<u>ETM IssueDate Field Check</u>	3.5.2.
9.8	<u>Structure ID Check</u>	3.5.4.
9.8	<u>Certificate Thumbprint Check</u>	3.5.5.
9.8	<u>KeyInfo Field Check</u>	3.5.7.
9.8	<u>KDM Malformations</u>	3.5.8.
9.8	<u>KDM Signature</u>	3.5.9.
9.8	<u>KDM NonCriticalExtensions Element (OBAE)</u>	3.5.10.

9.8	<u>Structure ID Check (OBAE)</u>	3.5.12.
9.8	<u>Certificate Thumbprint Check (OBAE)</u>	3.5.13.
9.8	<u>KeyInfo Field Check (OBAE)</u>	3.5.14.
9.8	<u>KDM Malformations (OBAE)</u>	3.5.15.
9.8	<u>KDM Signature (OBAE)</u>	3.5.16.
9.8	<u>KDM Date Check</u>	6.1.10.
9.8	<u>KDM TDL Check</u>	6.1.11.
9.8	<u>CPL Id Check</u>	6.1.13.
9.8	<u>CPL Id Check (OBAE)</u>	6.1.14.
9.8	<u>KDM Date Check (OBAE)</u>	6.1.24.
10.2.2	<u>Stereoscopic Image Frame Rates</u>	7.5.34.

APPENDIX H. ABBREVIATIONS

AD

Auxiliary Data

AES

Audio Engineering Society

AES

Advanced Encryption Standard

CMVP

Cryptographic Module Validation Program

CPL

Composition PlayList

DCI

Digital Cinema Initiatives, LLC

DCDM

Digital Cinema Distribution Master

DCP

Digital Cinema Package

DCSS

Digital Cinema System Specification

DSM

Digital Source Master

ETM

Extra Theater Message

FM

Forensic Marking

FMID

Forensic Marking Identification

FPGA

Field-Programmable Gate Array

GUI

Graphical User Interface

IMB

Image Media Block

IMBO

Image Media Block with OMB Functions

ISO

International Organization for Standards

IETF

Internet Engineering Task Force

J2K

JPEG2000

KDM

Key Delivery Message

LCD

Liquid Crystal Display

LD

Link Decryptor

LDB

Link Decryptor Block

LE

Link Encryptor

MB

Media Block

MD

Media Decryptor

NIST

National Institute of Science and Technology

NPRC

Non-Programmable Related Components

OBAE

Object Based Audio Essence

OMB

Outboard Media Block

POSIX

Portable Operating System Interface

RAID

Redundant Array of Independent Disks (formerly: Redundant Array of Inexpensive Disks)

SM

Security Manager

SMS

Screen Management System

SPB

Secure Processing Block

SPL

Show Play List

SMPTE

Society of Motion Picture and Television Engineers

StEM

Standard Evaluation Material

TCP/IP

Transmission Control Protocol/Internet Protocol

TDL

Trusted Device List

TLS

Transport Layer Security, also known as Secure Socket Layer (SSL)

TMS

Theater Management System

UMID

Unique Material Identifier

USB

Universal Serial Bus

UUID

Universally Unique Identifier

WTF

Wild Track Format (numbered audio channels)

XML

eXtensible Markup Language

APPENDIX I. SUBTITLE TEST EVALUATION AND PASS/FAIL CRITERIA

I.1. Overview

The following describes evaluation requirements, basic and specific pass/fail criteria to be used when testing the subtitle rendering capabilities of the Test Subject, as called for in [6.7.1. Media Block Overlay](#).

It is expected that the Test Operator shall, by referencing both the CPL and the referenced subtitle track file XML, confirm that all elements expected to appear on (or off) screen for each scene, do so with all intended characteristics. This includes, but is not limited to, positioning, alignment, font size, color, script, effect, effect color, italic, underline, bold, aspect adjust and spacing, whether specified directly, default values, or inherited from ancestor values or defaults.

The colorimetric relationship between the PNG image and the image contained in the DCDM* is, at the time of publication of this document, under study. Unexpected appearance of saturation, hue, luminance and bit-depth of PNG images should be

noted in the test results and brought to the attention of the manufacturer pending further work to quantify this relationship. At this time, the Test Subject shall not be subject to failing this test on such characteristics.

The behavior of the `Direction` attribute of the `Text` element and/or the Unicode Bidirectional Algorithm is, at the time of publication of this document, under study. Scenes that utilize these features should be noted in the test results and brought to the attention of the manufacturer pending further work to quantify this relationship. At this time, the Test Subject shall not be subject to failing this test on such characteristics

I.2. Basic Pass/Fail Criteria

This section describes general pass/fail criteria to be applied to all scenes unless Specific Criteria directs otherwise.

Main Picture Image Track Files - Labels: The image track files referenced by the compositions have a burned-in label in a small text font, centered horizontally and close to the bottom of the main picture. The label is comprised of the image structure of the sequence being viewed (2K, 4K, or 2K-48fps), the aspect ratio, and the name of the scene. The name of the scene may be used to locate specific pass/fail requirements for a particular scene, and descriptive notes to the test operator, providing additional context.

Bounding Boxes: White bounding boxes, with a one pixel size, are burned into the image track files to confirm correct positioning of the rendered timed text. Some slides, mainly those that announce upcoming scenes, present timed text that do not have bounding boxes. When bounding boxes are displayed, the associated text is intended to fall completely within the boxes. Differences in implementations can produce significant differences in the vertical positioning of text, depending on whether the renderer uses the baseline of the text characters, or the edges of the rendered characters for positioning. Exceeding the bounding boxes shall not be cause to fail the test.

Composition Main Picture and Alpha Channel Timing: The appearance of a particular label on the main picture, is intended to be accompanied by that scene's rendered text, and/or PNG images, as determined by the provided `FadeUpTime` and `FadeDownTime` Text and/or Image element parameters, or their default value of 2 frames if none are specified. For example, for the beginning title slide, "2K-scope-title", the image track file will display the label for 240 frames (10 seconds). The `FadeUpTime` and `FadeDownTime` parameters are not specified for the accompanying timed text, so for the 1st frame that displays the image label no timed text should be visible, the 2nd frame should have the timed text at 50% opacity of the rendered intent (the element's final opacity is specified by a parameter of the Font element), and frames 3 until 238 inclusive should have the timed text at 100% opacity of the rendered intent. Frame 239 should be identical to frame 2, and frame 240 should have no visible timed text. Except where specified, if the timing of the rendered text and/or PNG images differs by more than plus or minus 3 frames from that commanded by the Subtitle DCDM and the controlling CPL, this is cause to fail the test.

Some of the slides that test PNG images have `FadeUpTime` and `FadeDownTime` values of zero, so it is not expected, or correct behavior, for the corresponding image track labels to be visible with these slides.

I.3. Specific Pass/Fail Criteria

This section lists pass/fail criteria specific to each scene in the composition. The identifier for each scene is constructed by prepending the image structure and aspect-ratio for the variant under test to the scene title. E.g. "2K-scope-title" or "2K-48fpsflat-title" as applicable. For each of the scenes, refer to the text below the identifier. Descriptions of scene specific elements may be described more fully. Scene specific pass/fail requirements are presented as bullet lists.

Scene 1: <2K|4K[-48fps]-scope|flat|full>-title

The evaluation of the first scene, and all subsequent scenes, must be determined from the display of a normal, single, continuous playback of the composition. To clarify, the composition must be selected, or loaded into a show playlist, and caused to play without using functions such as "pause" or "rewind", which may cause buffering, or other system behaviors that may have an effect of the ability of the system to display subtitles with the correct timing relationship to the other essence tracks.

- The rendered subtitle text must appear on screen within 3 seconds of the appearance of the label in the main picture. If this requirement is not observed, this is cause to fail this test.

Scene 2: <2K|4K[-48fps]-scope|flat|full>-out-of-bounds-character-codes

- In the top bounding box, the appearance of any character, space, partial character, or partial space, other than the words "Digital", and "Cinema", with no spaces between them, is cause to fail this test.
- In the middle bounding box, the appearance of any character, or partial character, is cause to fail this test.
- In the lower bounding box, the appearance of any character, space, partial character, or partial space, other than the letters "ABCDEF", with no spaces between them, is cause to fail this test.

Scene 3: <2K|4K[-48fps]-scope|flat|full>-control-codes

- In the top bounding box, the appearance of any character, space, partial character, or partial space, other than the words "Digital", and "Cinema", with no spaces between them, is cause to fail this test.
- In the middle bounding box, the appearance of any character, or partial character, is cause to fail this test.
- In the lower bounding box, the appearance of any character, space, partial character, or partial space, other than the letters "ABCDEF", with no spaces between them, is cause to fail this test.

Scene 4: <2K|4K[-48fps]-scope|flat|full>-4-byte-UTF-8-characters

Record whether the Test Subject displays any rendered subtitles during this slide. Note: Failure to display four domino shapes is not cause to fail this test.

- If glyphs other than four domino shapes are displayed, this is cause to fail this test.

Scene 5: <2K|4K[-48fps]-scope|flat|full>-default-font-size-attribute

- If all the "M"s are not the same size, this is cause to fail this test.

Scene 6: <2K|4K[-48fps]-scope|flat|full>-font-effects-1

The text in this slide is intended to be red in color. The presence of the shadow and/or border, can cause the red to be perceived differently.

- If the size of the rendered characters does not vary in accordance with the labeled point values, this is cause to fail this test.
- If the body of all text is not substantially red, this is cause to fail this test.
- If any border or shadow effect is visible on any text labeled "No-shadow", this is cause to fail this test.
- If a green shadow effect is not visible on all text labeled "Green-Shadow", this is cause to fail this test.
- If any effect, other than a green shadow, is visible on any text labeled "Green-Shadow", this is cause to fail this test.
- If a white border effect is not visible on all text labeled "White-Border", this is cause to fail this test.
- If any effect, other than a white border, is visible on any text labeled "White-Border", this is cause to fail this test.

Scene 7: <2K|4K[-48fps]-scope|flat|full>-font-sub-super-script-1

- If the baseline of any of the words "Normal" is not on the same level vertically, this is cause to fail this test.
- If the baseline of the word "Super" is not above that of the words "Normal", this is cause to fail this test
- If the baseline of the word "Sub" is not below that of the words "Normal", this is cause to fail this test.
- If the size of the words "Super" and "Sub" is not 0.6em compared with the 1.0em size of the words "Normal", inform the manufacturer that the Test Subject may not be fully compliant with newer Standards, but do not fail the device on this criterion.
- If the baseline of the words "Super" and "Sub" is not offset by a minimum of 0.3em, and a maximum of 0.7em, of the baseline of the 1.0em size of the words "Normal", inform the manufacturer that the Test Subject may not be fully compliant with newer Standards, but do not fail the device on this criterion.

Scene 8: <2K|4K[-48fps]-scope|flat|full>-font-sub-super-script-2

The scene contains two subtitle instances indicated by their respective bounding boxes, one above the other, designated "upper" and "lower" accordingly.

- If the baseline of both the words "Normal" on each of the two instances is not on the same level vertically, inform the manufacturer that the Test Subject may not be fully compliant with newer Standards, but do not fail the device on this criterion.
- If the baseline of both the words "Super" is not above that of the words "Normal" on the upper instance, inform the manufacturer that the Test Subject may not be fully compliant with newer Standards, but do not fail the device on this criterion
- If the baseline of both the words "Sub" is not below that of the words "Normal" on the lower instance, inform the manufacturer that the Test Subject may not be fully compliant with newer Standards, but do not fail the device on this criterion
- If the baseline of the both the words "Super", or both the words "Sub", are not on the same level vertically, inform the manufacturer that the Test Subject may not be fully compliant with newer Standards, but do not fail the device on this criterion
- If the size of the both the words "Super", or both the words "Sub", are not the same, inform the manufacturer that the Test Subject may not be fully compliant with newer Standards, but do not fail the device on this criterion

Scene 9: <2K|4K[-48fps]-scope|flat|full>-font-sub-super-script-3

The scene contains two subtitle instances indicated by their respective bounding boxes, one above the other, designated "upper" and "lower" accordingly.

- For the upper instance, if the baselines of both the words "Super" are not on the same level, and above that of the word "Normal", inform the manufacturer that the Test Subject may not be fully compliant with newer Standards, but do not fail the device on this criterion
- for the lower instance, if the baselines of both the words "Sub" are not on the same level, and below that of the word "Normal", inform the manufacturer that the Test Subject may not be fully compliant with newer Standards, but do not fail the device on this criterion

Scene 10: <2K|4K[-48fps]-scope|flat|full>-font-italic-weight-bold-1

- If the text on any of the lines with the bounding boxes is not yellow, this is cause to fail this test.

- If the text in each of the three lines with the bounding boxes does not have font effects corresponding to the labels, this is cause to fail this test.

Scene 11: <2K|4K[-48fps]-scope|flat|full>-font-color-effectcolor-opacity-1

- If the opacity of the text in the left column does not vary according to the labels, this is cause to fail this test.
- If the opacity of the border effect around the text in the right column does not vary according to the labels, record the result.

Scene 12: <2K|4K[-48fps]-scope|flat|full>-position-screen-center-announce

- If rendered text, describing the following scene, is not displayed, this is cause to fail this test.

Scene 13: <2K|4K[-48fps]-scope|flat|full>-position-screen-center

- If the text is not near the center of the screen, this is cause to fail this test.

Scene 14: <2K|4K[-48fps]-scope|flat|full>-position-screen-4-edges-announce

- If rendered text, describing the following scene, is not displayed, this is cause to fail this test.

Scene 15: <2K|4K[-48fps]-scope|flat|full>-position-screen-4-edges

- If any of the labeled rendered texts are in an incorrect location, this is cause to fail this test.

Scene 16: <2K|4K[-48fps]-scope|flat|full>-position-screen-4-corners-announce

- If rendered text, describing the following scene, is not displayed, this is cause to fail this test.

Scene 17: <2K|4K[-48fps]-scope|flat|full>-position-screen-4-corners-1

With the publication of ST 428-7:2014, the behavior of the alignment of rendered Text elements has changed. In the 2010 revision, the top, center, or bottom of the subtitle instance bounding box is aligned to the primary picture according to the Valign attribute. The 2014 revision aligns the baseline of the rendered text to the primary picture according to the Valign attribute.

- If any of the labeled rendered texts are in an incorrect location, this is cause to fail this test.
- If the Test Subject implements the 2014 Standard, only the descenders of the "Top-Left" and "Top-Right" labels are expected to appear on screen. If this is the case, do not fail the device on this criterion. However, if rendered text is visible outside the limits of the primary picture, this is cause to fail this test.
- If the Test Subject implements the 2014 Standard, the descenders of the "Bottom-Left" and "Bottom-Right" labels are expected to not appear on screen. If this is the case, do not fail the device on this criterion. However, if rendered text is visible outside the limits of the primary picture, this is cause to fail this test.

Scene 18: <2K|4K[-48fps]-scope|flat|full>-position-screen-4-corners-2

With the publication of ST 428-7:2014, the behavior of the alignment of rendered Text elements has changed. In the 2010 revision, the top, center, or bottom of the subtitle instance bounding box is aligned to the primary picture according to the Valign attribute. The 2014 revision aligns the baseline of the rendered text to the primary picture according to the Valign attribute.

- If any of the labeled rendered texts are in an incorrect location, this is cause to fail this test.

Scene 19: <2K|4K[-48fps]-scope|flat|full>-position-text-off-screen-1

- Except for the scene identifier, and the sentence inside the bounding box, the presence of any other text, partial text, or rendered artifacts is cause to fail this test with the exception of the case noted in the following item.
- The display of some of the edge-most pixels from a single off-screen character at the edge of the screen is acceptable due to implicit variation in absolute font character placement. If any pixels are displayed from an off-screen text character, record the result.

Scene 20: <2K|4K[-48fps]-scope|flat|full>-position-text-off-screen-2

- Except for the scene identifier, and the sentence inside the bounding box, the presence of any other text, partial text, or rendered artifacts is cause to fail this test.

Scene 21: <2K|4K[-48fps]-scope|flat|full>-font-aspect-adjust-tests

- If either of the two shapes that have a horizontal bar across them are not circles, this is cause to fail this test.
- If the shapes to the left of the circle with the bar in the top row do not appear as progressively narrower ellipses (the further away they are) this is cause to fail this test.
- If the shapes to the right of the circle with the bar in the top row do not appear as progressively wider ellipses (the further away they are) this is cause to fail this test.
- If the spaces between the shapes appear inconsistent with the increasing width of the shapes, this is cause to fail this test.

Scene 22: <2K|4K[-48fps]-scope|flat|full>-space-element-tests

- If the pairs of "M"s are not farthest apart at the top, progressively becoming closer going down, and closest together at the bottom, this is cause to fail this test.

Scene 23: <2K|4K[-48fps]-scope|flat|full>-428-7-ruby-example-1

- If 3 CJK characters are not displayed with 6 CJK characters above them, this is cause to fail this test

Scene 24: <2K|4K[-48fps]-scope|flat|full>-428-7-ruby-example-2

- If 11 large CJK characters are not displayed, this is cause to fail this test
- If 2 small CJK characters are not displayed below the first 2 large CJK characters, this is cause to fail this test
- If 6 small CJK characters are not displayed below the fourth, fifth, and sixth large CJK characters, this is cause to fail this test

Scene 25: <2K|4K[-48fps]-scope|flat|full>-428-7-ruby-example-3

- If the horizontal text "1963" does not appear at the top, this is cause to fail this test
- If there are not 9 CJK characters, vertically rendered below the "1963", this is cause to fail this test.

Scene 26: <2K|4K[-48fps]-scope|flat|full>-ruby-test-1

- If smaller annotation text reading "World Wide Web" is not displayed close to, and centered above, the larger base text "WWW", this is cause to fail this test.

Scene 27: <2K|4K[-48fps]-scope|flat|full>-ruby-test-2

- If smaller annotation text reading "Month Day Year" is not displayed close to, and centered above, the larger base text "10 31 2002", this is cause to fail this test.

Scene 28: <2K|4K[-48fps]-scope|flat|full>-ruby-test-3

- If smaller annotation text reading "Expiration Date" is not displayed close to, and centered below, the larger base text "10 31 2002", this is cause to fail this test.

Scene 29: <2K|4K[-48fps]-scope|flat|full>-ruby-test-4

- If smaller annotation text reading "W3C Associate Chairman" is not displayed close to, and centered below, 4 larger CJK characters, this is cause to fail this test.

Scene 30: <2K|4K[-48fps]-scope|flat|full>-ruby-test-5

- If smaller, vertical annotation text reading "Shinkansen" from top to bottom, is not displayed close to, and centered on the left, and right sides of 3 larger vertical CJK characters, this is cause to fail this test.

Scene 31: <2K|4K[-48fps]-scope|flat|full>-ruby-aspectadjust-test

- If any of the shapes are not as described, or missing, this is cause to fail this test.

Scene 32: <2K|4K[-48fps]-scope|flat|full>-ruby-offset-test

The pair of labels with the text 'Offset="-1"' are not expected to be exactly aligned and may vary according to the implementation. The objective of the test is to show that an offset value of -1 causes the pair to be closer than a bigger number.

- If the size of both labels in all the pairs is not equal, this is cause to fail this test.
- If the vertical offset between the four pairs of rendered text labels is not greatest on the left and least on the right, this is cause to fail this test.
- If the vertical offset between the pair of labels 'Default Offset (0)' and 'Offset="0"' is not equal, this is cause to fail this test. Note: The parentheses descend below the baseline of the remainder of the characters, which can cause the text to be further apart in this instance.

Scene 33: <2K|4K[-48fps]-scope|flat|full>-ruby-spacing-test

The pair of circles with the label 'Spacing="-1"' are not expected to be exactly aligned and may vary according to the implementation. The objective of the test is to show that an offset value of -1 causes the pair to be closer than a bigger number.

- If the horizontal spacing between the four pairs of same colored circles is not greatest on the left and least on the right, this is cause to fail this test.
- If the horizontal spacing between the pair of green circles and the pair of blue circles is not equal, this is cause to fail this test.

Scene 34: <2K|4K[-48fps]-scope|flat|full>-ruby-cumulative-spacing-test

- If the spacing between the circles in each colored set is not equal, this is cause to fail this test.

Scene 35: <2K|4K[-48fps]-scope|flat|full>-image-main-picture-equivalency

- If the size of the two apples is not equal, this is cause to fail this test.

- Differences in saturation, hue, luminance and bit-depth between the two images should be noted in the test results, and brought to the attention of the manufacturer. At this time, the Test Subject shall not be subject to failing this test because of such differences.

Scene 36: <2K|4K[-48fps]-scope|flat|full>-image-positioning

Three PNG images, with associated descriptive text, will fade in, then fade out, in sequence during this scene. Each image is an exact third, horizontally, of the scope aspect-ratio. Note that the images, as displayed in the flat aspect-ratio variant, will be slightly larger than one third of the screen width, and will not fill the screen vertically in both the flat, and full, aspect-ratio variants (the images will have their top edge aligned with the top edge of the main picture).

- If the location of any image does not match the descriptive text, this is cause to fail this test.
- If any image, or associated descriptive text does not appear when expected, this is cause to fail this test.
- If any image, or associated descriptive text does not fade in, and fade out, when expected, this is cause to fail this test.
- If the size of any image does not meet the description above, this is cause to fail this test.

Scene 37: <2K|4K[-48fps]-scope|flat|full>-image-to-image-transition-test-1-announce

- If rendered text, describing the following scene, is not displayed, this is cause to fail this test.

Scene 38: <2K|4K[-48fps]-scope|flat|full>-image-to-image-transition-test-1

A single PNG image will fill the entire screen horizontally for the first half of this scene. For the second half of the scene, the single image will be replaced by two half horizontal screen images, positioned as to be equivalent to their locations on the single image. All `FadeDownTime` and `FadeUpTime` elements are set to 00:00:00:00 which will result in a seamless transition between the subtitle instances.

- If the image displayed on the screen flickers, or any part of the image is not displayed, record the result.

Scene 39: <2K|4K[-48fps]-scope|flat|full>-image-image-text-transparency-test-1-announce

- If rendered text, describing the following scene, is not displayed, this is cause to fail this test.
- For 4K test material, some renderers may be unable to display images without flickering, lagging or may display images incompletely. If the renderer displays image anomalies with 4K test material, record the result.

Scene 40: <2K|4K[-48fps]-scope|flat|full>-image-image-text-transparency-test-1

This scene will display a PNG image of a seascape overlaid with a PNG image of a square yellow frame with a transparent background. Inside the yellow frame will be the rendered text "Digital Cinema", in purple.

- If the seascape, square frame, or rendered text is missing, this is cause to fail this test.
- If the seascape is not visible through both the square frame and the rendered text, this is cause to fail this test.
- For 4K test material, some renderers may be unable to display images without flickering, lagging or may display images incompletely. If the renderer displays image anomalies with 4K test material, record the result.

Scene 41: <2K|4K[-48fps]-scope|flat|full>-image-image-image-transparency-test-1-announce

- If rendered text, describing the following scene, is not displayed, this is cause to fail this test.
- For 4K test material, some renderers may be unable to display images without flickering, lagging or may display images incompletely. If the renderer displays image anomalies with 4K test material, record the result.

Scene 42: <2K|4K[-48fps]-scope|flat|full>-image-image-image-transparency-test-1

This scene will display a PNG image of a seascape overlaid with a PNG image of a square yellow frame with a transparent background. Inside the yellow frame is overlaid a PNG image of a smaller, rectangular purple frame and the text "Digital Cinema", in purple, and a transparent background.

- If the seascape, square frame, smaller rectangular frame, or PNG text are missing, this is cause to fail this test.
- If the seascape is not visible through both the square frame, the rectangular frame, and the text, this is cause to fail this test.
- For 4K test material, some renderers may be unable to display images without flickering, lagging or may display images incompletely. If the renderer displays image anomalies with 4K test material, record the result.

Scene 43: <2K|4K[-48fps]-scope|flat|full>-image-image-text-transparency-test-2-announce

- If rendered text, describing the following scene, is not displayed, this is cause to fail this test.
- For 4K test material, some renderers may be unable to display images without flickering, lagging or may display images incompletely. If the renderer displays image anomalies with 4K test material, record the result.

Scene 44: <2K|4K[-48fps]-scope|flat|full>-image-image-text-transparency-test-2

This scene will display a PNG image of a seascape overlaid with rendered text. Overlaid over the text, is a PNG image of a rose that has a transparent background. The rose will completely cover the rendered text.

- If the seascape, or the rose, are missing, this is cause to fail this test.
- If the seascape is not visible up to the edges of the rose, this is cause to fail this test.
- If any text is visible, other than the scene label in the flat and full variants, this is cause to fail this test.
- For 4K test material, some renderers may be unable to display images without flickering, lagging or may display images incompletely. If the renderer displays image anomalies with 4K test material, record the result.

Scene 45: <2K|4K[-48fps]-scope|flat|full>-image-transparency-test-1

This scene will display a green background in the main picture. Overlaid in the center, is a PNG image of a house that has transparent windows.

- If a house is not displayed in the center of the green background, this is cause to fail this test.
- If the green background is not visible through the windows of the house, this is cause to fail this test.
- For 4K test material, some renderers may be unable to display images without flickering, lagging or may display images incompletely. If the renderer displays image anomalies with 4K test material, record the result.

Scene 46: <2K|4K[-48fps]-scope|flat|full>-multi-image-multi-text-test-announce

- If rendered text, describing the following scene, is not displayed, this is cause to fail this test.
- For 4K test material, some renderers may be unable to display images without flickering, lagging or may display images incompletely. If the renderer displays image anomalies with 4K test material, record the result.

Scene 47: <2K|4K[-48fps]-scope|flat|full>-multi-image-multi-text-test

In the first half of this scene, PNG images of a house and rose, each with descriptive text overlaid, will fade in. Halfway through the scene, PNG images of an apple and a lamp, each with descriptive text, will fade in, for a total of

four PNG images and four descriptive text overlays.

- If the PNG images of the house and rose, with their respective text overlays, do not appear during the first half of the scene, and do not remain on screen after their appearance, for the remainder of the scene, this is cause to fail this test.
- If the PNG images of the apple and lamp, with their respective text overlays, do not appear on screen during the second half of the scene, this is cause to fail this test.
- Per the provisions of section 6.1.6 in SMPTE ST 428-7:2014, in cases where two subtitle instances have overlapping time windows, the values of `FadeUpTime` and `FadeDownTime` elements, or their defaults, may be considered to be equal to zero. If any of the fades specified in the XML are rendered as if they were zero, this shall not be cause to fail this test.
- For 4K test material, some renderers may be unable to display images without flickering, lagging or may display images incompletely. If the renderer displays image anomalies with 4K test material, record the result.

Scene 48: <2K|4K[-48fps]-scope|flat|full>-image-rose-flicker-test-announce

- If rendered text, describing the following scene, is not displayed, this is cause to fail this test.
- For 4K test material, some renderers may be unable to display images without flickering, lagging or may display images incompletely. If the renderer displays image anomalies with 4K test material, record the result.

Scene 49: <2K|4K[-48fps]-scope|flat|full>-image-rose-flicker-test

- If a rose does not appear near the center of the screen, this is cause to fail this test.
- If the rose flickers, disappears, or exhibits any other dynamic visual artifacts, this is cause to fail this test.
- For 4K test material, some renderers may be unable to display images without flickering, lagging or may display images incompletely. If the renderer displays image anomalies with 4K test material, record the result.

Scene 50: <2K|4K[-48fps]-scope|flat|full>-text-flicker-test

- If text inside the bounding box does not appear on the screen, this is cause to fail this test.
- If the text flickers, disappears, or exhibits any other dynamic visual artifacts, this is cause to fail this test.

Scene 51: <2K|4K[-48fps]-scope|flat|full>-text-direction-test-1

This scene is for informational data only. Describe the appearance of the rendered text elements displayed on the screen.

Scene 52: <2K|4K[-48fps]-scope|flat|full>-text-direction-test-2

This scene is for informational data only. Describe the appearance of the rendered text elements displayed on the screen.

Scene 53: <2K|4K[-48fps]-scope|flat|full>-text-direction-test-3

This scene is for informational data only. Describe the appearance of the rendered text elements displayed on the screen.

Scene 54: <2K|4K[-48fps]-scope|flat|full>-text-valign-direction-test-1

This scene is for informational data only. Describe the appearance of the rendered text elements displayed on the screen.

Scene 55: <2K|4K[-48fps]-scope|flat|full>-end-title

- If the rendered text does not appear on the screen, this is cause to fail this test.

APPENDIX J. OBAE TEST EVALUATION REQUIREMENTS

J.1. Overview

This appendix specifies requirements and expected acoustic outcome from the rendering of *OBAE Rendering Expectations* by an **OBAE Sound System**.

J.2. Configuration

The **OBAE Sound System** shall be configured as an *Ideal Environment*, as specified at [SMPTE-2098-3].

J.3. Requirements

The test material consists of a sequence of scenes, identified in the top right corner of the image, as illustrated at [Figure J.1](#).

The expectations for each scene are described using a combination of text and images, as illustrated at [Figure J.1](#).

Sounds heard during each scene shall conform to the expectations specified for the scene by the corresponding table in [J.4. Expectations](#).

There shall be no sounds heard other than those specified at [J.4. Expectations](#).

Expectations that refer to a specific loudspeaker, e.g. "Left Speaker", shall be skipped if the **OBAE Sound System** is not equipped with that loudspeaker.

Loudspeakers are defined at [SMPTE-428-12] and [SMPTE-2098-5].

All sounds heard shall be free of artifacts, e.g. "zipper" noise, discontinuities, clicks.

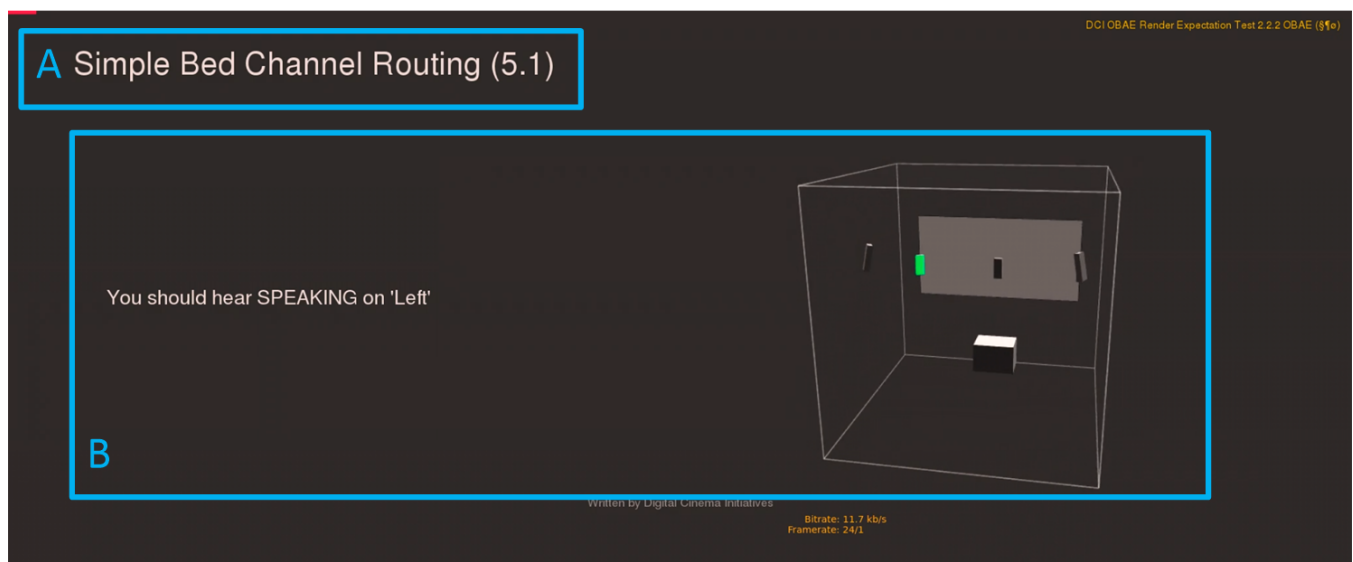

- Text identifying the scene.
- Text and imagery indicating rendering expectations.

Figure J.1. Visual contents of the OBAE Rendering Expectations test material

J.4. Expectations

Table J.4.1. Sync Test

Text on screen	Expectations
BEEP!	A sound is heard

Table J.4.2. Simple Bed Channel Routing (5.1)

Text on screen	Expectations
You should hear SPEAKING on 'Left'	The word "left" is heard from the Left speaker
You should hear PINK on 'Left'	Pink noise is heard from the Left speaker
You should hear SPEAKING on 'Right'	The word "right" is heard from the Right speaker
You should hear PINK on 'Right'	Pink noise is heard from the Right speaker
You should hear SPEAKING on 'Center'	The word "center" is heard from the Center speaker
You should hear PINK on 'Center'	Pink noise is heard from the Center speaker
You should hear SPEAKING on 'LFE'	Sound is heard from the LFE speaker
You should hear PINK on 'LFE'	Pink noise is heard from the LFE speaker
You should hear SPEAKING on 'Left Surround'	The word "left surround" is heard from the Left Surround speaker
You should hear PINK on 'Left Surround'	Pink noise is heard from the Left Surround speaker
You should hear SPEAKING on 'Right Surround'	The word "right surround" is heard from the Right Surround speaker
You should hear PINK on 'Right Surround'	Pink noise is heard from the Right Surround speaker

Table J.4.3. Simple Bed Channel Routing (7.1DS)

Text on screen	Expectations
You should hear SPEAKING on 'Left'	The word "left" is heard from the Left speaker
You should hear PINK on 'Left'	Pink noise is heard from the Left speaker
You should hear SPEAKING on 'Right'	The word "right" is heard from the Right speaker
You should hear PINK on 'Right'	Pink noise is heard from the Right speaker
You should hear SPEAKING on 'Center'	The word "center" is heard from the Center speaker
You should hear PINK on 'Center'	Pink noise is heard from the Center speaker
You should hear SPEAKING on 'LFE'	Sound is heard from the LFE speaker
You should hear PINK on 'LFE'	Pink noise is heard from the LFE speaker
You should hear SPEAKING on 'Left Side Surround'	The word "left side surround" is heard from the Left Side Surround speaker
You should hear PINK on 'Left Side Surround'	Pink noise is heard from the Left Side Surround speaker

You should hear PINK on 'Right Side Surround'	Pink noise is heard from the Right Side Surround speaker
You should hear SPEAKING on 'Left Rear Surround'	The word "left rear surround" is heard from the Left Rear Surround speaker
You should hear PINK on 'Left Rear Surround'	Pink noise is heard from the Left Rear Surround speaker
You should hear SPEAKING on 'Right Rear Surround'	The word "right rear surround" is heard from the Right Rear Surround speaker
You should hear PINK on 'Right Rear Surround'	Pink noise is heard from the Right Rear Surround speaker

Table J.4.4. Simple Bed Channel Routing (9.1OH)

Text on screen	Expectations
You should hear SPEAKING on 'Left'	The word "left" is heard from the Left speaker
You should hear PINK on 'Left'	Pink noise is heard from the Left speaker
You should hear SPEAKING on 'Right'	The word "right" is heard from the Right speaker
You should hear PINK on 'Right'	Pink noise is heard from the Right speaker
You should hear SPEAKING on 'Center'	The word "center" is heard from the Center speaker
You should hear PINK on 'Center'	Pink noise is heard from the Center speaker
You should hear SPEAKING on 'LFE'	Sound is heard from the LFE speaker
You should hear PINK on 'LFE'	Sound is heard from the LFE speaker
You should hear SPEAKING on 'Left Side Surround'	The word "left side surround" is heard from the Left Side Surround speaker
You should hear PINK on 'Left Side Surround'	Pink noise is heard from the Left Side Surround speaker
You should hear SPEAKING on 'Right Side Surround'	The word "right side surround" is heard from the Right Side Surround speaker
You should hear PINK on 'Right Side Surround'	Pink noise is heard from the Right Side Surround speaker
You should hear SPEAKING on 'Left Rear Surround'	The word "left rear surround" is heard from the Left Rear Surround speaker
You should hear PINK on 'Left Rear Surround'	Pink noise is heard from the Left Rear Surround speaker
You should hear SPEAKING on 'Right Rear Surround'	The word "right rear surround" is heard from the Right Rear Surround speaker
You should hear PINK on 'Right Rear Surround'	Pink noise is heard from the Right Rear Surround speaker
You should hear SPEAKING on 'Left Top Surround'	The word "left top surround" is heard from the Left Top Surround speaker
You should hear PINK on 'Left Top Surround'	Pink noise is heard from the Left Top Surround speaker

You should hear PINK on 'Right Top Surround'	Pink noise is heard from the Right Top Surround speaker
--	---

Table J.4.5. '91OH' Bed - Gain Test

Text on screen	Expectations
You should hear pink-noise GainPrefix = ONE	Pink noise is heard. The noise maintains consistent timbre, loudness, and size.
You should hear Silence GainPrefix = zero	No sound is heard.
You should hear the volume changing GainPrefix = CUSTOM gain=X.XX	Pink noise is heard. For three times in a row, the loudness of the pink noise monotonically increases from silence, and then monotonically decrease back to silence. The loudness scales with the value of gain. The noise maintains consistent timbre and size.

Table J.4.6. '91OH' Bed - Decorrelation Test

Text on screen	Expectations
You should hear pink noise ChannelDecorCoefPrefix = NONE	Pink noise is heard.
You should hear pink noise ChannelDecorCoefPrefix = MAX	Pink noise is heard.
You should hear pink noise ChannelDecorCoefPrefix = CUSTOM XX%	Pink noise is heard. The noise maintains consistent loudness.

Table J.4.7. Pink Noise 13.1HT Bed with 3 Spoken Conditional Beds

Text on screen	Expectations
You should not hear pink noise The 13.1HT pink noise is superseded by one of the 5.1, 7.1DS, 9.10H beds	No sound is heard.

Table J.4.8. Bed Remap Test (Source: 13.1HT Bed, Dest: 5.1, 7.1DS, 11.1HT, 9.10H)

Text on screen	Expectations
You should only hear pink noise on Center (NOT from Left)	Pink noise is heard from the Center speaker only
You should only hear pink noise on Right (NOT from Center)	Pink noise is heard from the Right speaker only
You should only hear pink noise on Left (NOT from Right)	Pink noise is heard from the Left speaker only
You should only hear pink noise on Center (NOT from Left Side Surround)	Pink noise is heard from the Center speaker only
You should only hear pink noise on Left (NOT from Right Side Surround)	Pink noise is heard from the Left speaker only
You should only hear pink noise on Center (NOT from Left Rear Surround)	Pink noise is heard from the Center speaker only

You should only hear pink noise on Left (NOT from Right Rear Surround)	Pink noise is heard from the Left speaker only
You should only hear pink noise on Right (NOT from LFE)	Pink noise is heard from the Right speaker only
You should only hear pink noise on Center (NOT from Left Height)	Pink noise is heard from the Center speaker only
You should only hear pink noise on Right (NOT from Center Height)	Pink noise is heard from the Right speaker only
You should only hear pink noise on Left (NOT from Right Height)	Pink noise is heard from the Left speaker only
You should only hear pink noise on Center (NOT from Left Surround Height)	Pink noise is heard from the Center speaker only
You should only hear pink noise on Left (NOT from Right Surround Height)	Pink noise is heard from the Left speaker only
You should only hear pink noise on Right (NOT from Top Surround)	Pink noise is heard from the Right speaker only

The noise maintains consistent timbre and loudness in each test.

Table J.4.9. Mixing of Two Simultaneous Beds

Text on screen	Expectations
You should hear: SPEAKING on 'Left'	The word "left" is heard from the Left speaker
You should hear: PINK on 'Left'	Pink noise is heard from the Left speaker
You should hear: SPEAKING on 'Left Center'	The word "left center" is heard from the Left Center speaker
You should hear: PINK on 'Left Center'	Pink noise is heard from the Left Center speaker
You should hear: SPEAKING on 'Center'	The word "center" is heard from the Center speaker
You should hear: PINK on 'Center'	Pink noise is heard from the Center speaker
You should hear: SPEAKING on 'Right Center'	The word "right center" is heard from the Right Center speaker
You should hear: PINK on 'Right Center'	Pink noise is heard from the Right Center speaker
You should hear: SPEAKING on 'Right'	The word "right" is heard from the Right speaker
You should hear: PINK on 'Right'	Pink noise is heard from the Right speaker
You should hear: SPEAKING on 'Left Side Surround'	The word "left side surround" is heard from the Left Side Surround speaker
You should hear: PINK on 'Left Side Surround'	Pink noise is heard from the Left Side Surround speaker
You should hear: SPEAKING on 'Left Surround'	The word "left surround" is heard from the Left Surround speaker
You should hear: PINK on 'Left Surround'	Pink noise is heard from the Left Surround speaker
You should hear: SPEAKING on 'Left Rear Surround'	The word "left rear surround" is heard from the Left Rear Surround speaker

You should hear: SPEAKING on 'Right Rear Surround'	The word "right rear surround" is heard from the Right Rear Surround speaker
You should hear: PINK on 'Right Rear Surround'	Pink noise is heard from the Right Rear Surround speaker
You should hear: SPEAKING on 'Right Side Surround'	The word "right side surround" is heard from the Right Side Surround speaker
You should hear: PINK on 'Right Side Surround'	Pink noise is heard from the Right Side Surround speaker
You should hear: SPEAKING on 'Right Surround'	The word "right surround" is heard from the Right Surround speaker
You should hear: PINK on 'Right Surround'	Pink noise is heard from the Right Surround speaker
You should hear: SPEAKING on 'Left Top Surround'	The word "left top surround" is heard from the Left Top Surround speaker
You should hear: PINK on 'Left Top Surround'	Pink noise is heard from the Left Top Surround speaker
You should hear: SPEAKING on 'Right Top Surround'	The word "right top surround" is heard from the Right Top Surround speaker
You should hear: PINK on 'Right Top Surround'	Pink noise is heard from the Right Top Surround speaker
You should hear: SPEAKING on 'LFE'	Sound is heard from the LFE speaker
You should hear: PINK on 'LFE'	Sound is heard from the LFE speaker
You should hear: SPEAKING on 'Left Height'	The word "left height" is heard from the Left Height speaker
You should hear: PINK on 'Left Height'	Pink noise is heard from the Left Height speaker
You should hear: SPEAKING on 'Right Height'	The word "right height" is heard from the Right Height speaker
You should hear: PINK on 'Right Height'	Pink noise is heard from the Right Height speaker
You should hear: SPEAKING on 'Center Height'	The word "center height" is heard from the Center Height speaker
You should hear: PINK on 'Center Height'	Pink noise is heard from the Center Height speaker
You should hear: SPEAKING on 'Left Surround Height'	The word "left surround height" is heard from the Left Surround Height speaker
You should hear: PINK on 'Left Surround Height'	Pink noise is heard from the Left Surround Height speaker
You should hear: SPEAKING on 'Right Surround Height'	The word "right surround height" is heard from the Right Surround Height speaker
You should hear: PINK on 'Right Surround Height'	Pink noise is heard from the Right Surround Height speaker
You should hear: SPEAKING on 'Left Side Surround Height'	The word "left side surround height" is heard from the Left Side Surround Height speaker
You should hear: PINK on 'Left Side Surround Height'	Pink noise is heard from the Left Side Surround Height speaker

You should hear: SPEAKING on 'Right Side Surround Height'	The word "right side surround height" is heard from the Right Side Surround Height speaker
You should hear: PINK on 'Right Side Surround Height'	Pink noise is heard from the Right Side Surround Height speaker
You should hear: SPEAKING on 'Left Rear Surround Height'	The word "left rear surround height" is heard from the Left Rear Surround Height speaker
You should hear: PINK on 'Left Rear Surround Height'	Pink noise is heard from the Left Rear Surround Height speaker
You should hear: SPEAKING on 'Right Rear Surround Height'	The word "right rear surround height" is heard from the Right Rear Surround Height speaker
You should hear: PINK on 'Right Rear Surround Height'	Pink noise is heard from the Right Rear Surround Height speaker
You should hear: SPEAKING on 'Top Surround'	The word "top surround" is heard from the Top Surround speaker
You should hear: PINK on 'Top Surround'	Pink noise is heard from the Top Surround speaker

Table J.4.10. Object Gain Test

Text on screen	Expectations
You should hear pink noise GainPrefix = ONE	Pink noise is heard. The noise maintains consistent timbre, location, size and loudness.
You should hear silence GainPrefix = ZERO	No sound is heard.
You should hear the volume changing GainPrefix = CUSTOME (X.XX)	Pink noise is heard. Three times in a row, the loudness of the pink noise monotonically increases from silence, and then monotonically decrease back to silence. The loudness scales with the value of GainPrefix. The noise maintains consistent timbre and size.

Table J.4.11. Object Snap Test

Text on screen	Expectations
Snap off Angle: XXX°	A point source emitting pink noise is heard, making four revolutions clockwise around the room. The motion of the point source is continuous.
Snap On Angle: XXX°	A point source emitting pink noise is heard, making four revolutions clockwise around the room. Sound is heard from only one loudspeaker at any given time.
SnapTolerance Angle: XXX°	A point source emitting pink noise is heard, making four revolutions clockwise around the room. Sound may be heard from one or more loudspeakers at any given time.

The noise maintains consistent timbre, loudness, and size in each test.

Table J.4.12. Object Zone Gain Test (using ZERO/ONE gain flags)

Text on screen	Expectations
----------------	--------------

Angle: XXX° You should hear pink noise ONLY in the SCREEN LEFT zone	Pink noise is heard only from screen loudspeakers left of center.
Angle: XXX° You should hear pink noise ONLY in the SCREEN CENTER zone	Pink noise is heard only from screen center loudspeakers.
Angle: XXX° You should hear pink noise ONLY in the SCREEN RIGHT zone	Pink noise is heard only from screen loudspeakers right of center.
Angle: XXX° You should hear pink noise ONLY in the WALL LEFT zone	Pink noise is heard only from loudspeakers on left wall.
Angle: XXX° You should hear pink noise ONLY in the WALL RIGHT zone	Pink noise is heard only from loudspeakers on right wall.
Angle: XXX° You should hear pink noise ONLY in the REAR LEFT zone	Pink noise is heard only from loudspeakers on left half of rear wall.
Angle: XXX° You should hear pink noise ONLY in the REAR RIGHT zone	Pink noise is heard only from loudspeakers on right half of rear wall.
Angle: XXX° You should hear pink noise ONLY in the OVERHEAD LEFT zone	Pink noise is heard only from overhead loudspeakers left of center.
Angle: XXX° You should hear pink noise ONLY in the OVERHEAD RIGHT zone	Pink noise is heard only from overhead loudspeakers right of center.

The noise maintains consistent timbre, loudness, and size in each test.

Table J.4.13. Object Zone Gain Test (using decimal gain)

Text on screen	Expectations
Angle: XXX° You should hear pink noise ONLY in the SCREEN LEFT zone	Pink noise is heard only from screen loudspeakers left of center.
Angle: XXX° You should hear pink noise ONLY in the SCREEN CENTER zone	Pink noise is heard only from screen center loudspeakers.
Angle: XXX° You should hear pink noise ONLY in the SCREEN RIGHT zone	Pink noise is heard only from screen loudspeakers right of center.
Angle: XXX° You should hear pink noise ONLY in the WALL LEFT zone	Pink noise is heard only from loudspeakers on left wall.
Angle: XXX° You should hear pink noise ONLY in the WALL RIGHT zone	Pink noise is heard only from loudspeakers on right wall.

Angle: XXX° You should hear pink noise ONLY in the REAR LEFT zone	Pink noise is heard only from loudspeakers on left half of rear wall.
Angle: XXX° You should hear pink noise ONLY in the REAR RIGHT zone	Pink noise is heard only from loudspeakers on right half of rear wall.
Angle: XXX° You should hear pink noise ONLY in the OVERHEAD LEFT zone	Pink noise is heard only from overhead loudspeakers left of center.
Angle: XXX° You should hear pink noise ONLY in the OVERHEAD RIGHT zone	Pink noise is heard only from overhead loudspeakers right of center.

The noise maintains consistent timbre, loudness, and size in each test.

Table J.4.14. Object Spread Test

Text on screen	Expectations
Location: Overhead Spread Mode: Low-Rez Spread Value: X.XX	Pink noise is heard centered overhead. The perceived extent of the sound source may fluctuates with the Spread Value.
Location: Overhead Spread Mode: One-D Spread Value: X.XX	Pink noise is heard centered overhead. The perceived extent of the sound source may fluctuates with the Spread Value.
Location: Overhead Spread Mode: Three-D Spread Value: x=X.XX, y=X.XX, z=X.XX	Pink noise is heard centered on the screen. The perceived extent of the sound source may fluctuates with the Spread Value.
Location: Screen Spread Mode: Low-Rez Spread Value: X.XX	Pink noise is heard centered on the screen. The perceived extent of the sound source may fluctuates with the Spread Value.
Location: Screen Spread Mode: One-D Spread Value: X.XX	Pink noise is heard centered on the screen. The perceived extent of the sound source may fluctuates with the Spread Value.
Location: Screen Spread Mode: Three-D Spread Value: x=X.XX, y=X.XX, z=X.XX	Pink noise is heard centered on the screen. The perceived extent of the sound source may fluctuates with the Spread Value.

The noise maintains consistent loudness in each test.

Table J.4.15. Object - Decorrelation Test

Text on screen	Expectations
You should hear pink noise ObjectDecorCoefPrefix = NONE Location: Screen	Pink noise is heard, centered on the screen.
You should hear pink noise ObjectDecorCoefPrefix = MAX Location: Screen	Pink noise is heard, centered on the screen.
You should hear pink noise ObjectDecorCoefPrefix = CUSTOM (XX%)	

Location: Screen	Pink noise is heard, centered on the screen.
You should hear pink noise ObjectDecorCoefPrefix = NONE Location: Rear	Pink noise is heard, centered on the rear wall.
You should hear pink noise ObjectDecorCoefPrefix = MAX Location: Rear	Pink noise is heard, centered on the rear wall.
You should hear pink noise ObjectDecorCoefPrefix = CUSTOM (XX%) Location: Rear	Pink noise is heard, centered on the rear wall.
You should hear pink noise ObjectDecorCoefPrefix = NONE Location: Left	Pink noise is heard, centered on the left wall.
You should hear pink noise ObjectDecorCoefPrefix = MAX Location: Left	Pink noise is heard, centered on the left wall.
You should hear pink noise ObjectDecorCoefPrefix = CUSTOM (XX%) Location: Left	Pink noise is heard, centered on the left wall.
You should hear pink noise ObjectDecorCoefPrefix = NONE Location: Right	Pink noise is heard, centered on the right wall.
You should hear pink noise ObjectDecorCoefPrefix = MAX Location: Right	Pink noise is heard, centered on the right wall.
You should hear pink noise ObjectDecorCoefPrefix = CUSTOM (XX%) Location: Right	Pink noise is heard, centered on the right wall.

The noise maintains consistent loudness in each test.

Table J.4.16. Multiple Objects (3) combined with Snap/Spread Test

Text on screen	Expectations
You should hear a 3 note chord (one note per object) Spread On	A sound is heard, centered on the screen.
You should hear a 3 note chord (one note per object) Snap Off, Spread Off	A sound is heard, centered on the screen.
You should hear a 3 note chord (one note per object) Snap On	A sound is heard, centered on the screen.
You should hear a 3 note chord (one note per object) SnapTolerance	A sound is heard, centered on the screen.

Table J.4.17. Pan Sub-Block Test #2

Text on screen	Expectations
Sub-blocks: XXXXXX RPM: XX Angle: XXXXXXXX	Pink noise is heard, moving clockwise around the room. The noise maintains consistent loudness, timbre and size.

Table J.4.18. 10 Simultaneous Objects, No Bed

Text on screen	Expectations
You should hear no drop-outs Active Object: XX	Pink noise is heard. The noise maintains consistent loudness and timbre. The location of the noise may shift but remains primarily on the screen.

Table J.4.19. 15 Simultaneous Objects, No Bed

Text on screen	Expectations
You should hear no drop-outs Active Object: XX	Pink noise is heard. The noise maintains consistent loudness and timbre. The location of the noise may shift but remains primarily on the screen.

Table J.4.20. 18 Simultaneous Objects, No Bed

Text on screen	Expectations
You should hear no drop-outs Active Object: XX	Pink noise is heard. The noise maintains consistent loudness and timbre. The location of the noise may shift but remains primarily on the screen.

Table J.4.21. 30 Simultaneous Objects, No Bed

Text on screen	Expectations
You should hear no drop-outs Active Object: XX	Pink noise is heard. The noise maintains consistent loudness and timbre. The location of the noise may shift but remains primarily on the screen.

Table J.4.22. 50 Simultaneous Objects, No Bed

Text on screen	Expectations
You should hear no drop-outs Active Object: XX	Pink noise is heard. The noise maintains consistent loudness and timbre. The location of the noise may shift but remains primarily on the screen.

Table J.4.23. 128 Simultaneous Objects, No Bed

Text on screen	Expectations
You should hear no drop-outs Active Object: XX	Pink noise is heard. The noise maintains consistent loudness and timbre. The location of the noise may shift but should remain primarily on the screen.

Table J.4.24. 10 Simultaneous Objects, Quiet 9.10H Bed

Text on screen	Expectations
-----------------------	---------------------

<p>You should hear no drop-outs Active Object: XX</p>	<p>Pink noise is heard. The noise maintains consistent loudness and timbre. The location of the noise may shift but should remain primarily on the screen.</p>
---	--

Table J.4.25. 15 Simultaneous Objects, Quiet 9.1OH Bed

Text on screen	Expectations
<p>You should hear no drop-outs Active Object: XX</p>	<p>Pink noise is heard. The noise maintains consistent loudness and timbre. The location of the noise may shift but should remain primarily on the screen.</p>

Table J.4.26. 18 Simultaneous Objects, Quiet 9.1OH Bed

Text on screen	Expectations
<p>You should hear no drop-outs Active Object: XX</p>	<p>Pink noise is heard. The noise maintains consistent loudness and timbre. The location of the noise may shift but should remain primarily on the screen.</p>

Table J.4.27. 30 Simultaneous Objects, Quiet 9.1OH Bed

Text on screen	Expectations
<p>You should hear no drop-outs Active Object: XX</p>	<p>Pink noise is heard. The noise maintains consistent loudness and timbre. The location of the noise may shift but should remain primarily on the screen.</p>

Table J.4.28. 50 Simultaneous Objects, Quiet 9.1OH Bed

Text on screen	Expectations
<p>You should hear no drop-outs Active Object: XX</p>	<p>Pink noise is heard. The noise maintains consistent loudness and timbre. The location of the noise may shift but should remain primarily on the screen.</p>

Table J.4.29. 118 Simultaneous Objects, Quiet 9.1OH Bed

Text on screen	Expectations
<p>You should hear no drop-outs Active Object: XX</p>	<p>Pink noise is heard. The noise maintains consistent loudness and timbre. The location of the noise may shift but should remain primarily on the screen.</p>

Table J.4.30. Authoring Tool Info Test

Text on screen	Expectations
<p>You should hear a 5.1 pink-noise bed Note: authoring info located at the Beginning of the iaFrame ChildElements</p>	<p>Pink noise is heard. The noise maintains consistent loudness, timbre and size.</p>

Table J.4.31. Authoring Tool Info Test

Text on screen	Expectations
<p>You should hear a 5.1 pink-noise bed Note: authoring info located at the End of the iaFrame ChildElements</p>	<p>Pink noise is heard. The noise maintains consistent loudness, timbre and size.</p>

Table J.4.32. Unknown Element Test

Text on screen	Expectations
You should hear a 5.1 pink-noise bed Unknown element located at the beginning of the IAFrame	Pink noise is heard. The noise maintains consistent loudness, timbre and size.

Table J.4.33. Unknown Element Test

Text on screen	Expectations
You should hear a 5.1 pink-noise bed Unknown element located at the end of the IAFrame	Pink noise is heard. The noise maintains consistent loudness, timbre and size.

Table J.4.34. User Data Test

Text on screen	Expectations
You should hear a 5.1 pink-noise bed User Data located at the Beginning of the iaFrame ChildElements	Pink noise is heard. The noise maintains consistent loudness, timbre and size.

Table J.4.35. User Data Test

Text on screen	Expectations
You should hear a 5.1 pink-noise bed User Data located at the End of the iaFrame ChildElements	Pink noise is heard. The noise maintains consistent loudness, timbre and size.

Table J.4.36. Audio Description Test

Text on screen	Expectations
You should hear a pink-noise bed Audio Description: AMBIENCE, EFFECTS	Pink noise is heard.
You should hear a pink-noise bed Audio Description: DIALOG, FOLEY, MUSIC	Pink noise is heard.
You should hear a pink-noise bed Audio Description: AMBIENCE, DIALOG	Pink noise is heard.
You should hear a pink-noise bed Audio Description: MUSIC	Pink noise is heard.
You should hear a pink-noise bed Audio Description: AMBIENCE, DIALOG, EFFECTS	Pink noise is heard.
You should hear a pink-noise bed Audio Description: ADDITIONAL, DIALOG Note: there is a custom Audio Description present	Pink noise is heard.

The noise maintains consistent loudness, timbre and size in each test.

APPENDIX K. SUMMARY OF SUBSTANTIVE CHANGES

K.1. Overview

This appendix summarizes changes across releases of the CTP, which are listed in [Table K.1](#).

This appendix is informative and shall not be used to perform or interpret the contents of the CTP.

Table K.1. CTP releases

Version	Release date	Summary of changes
1.0	October 16, 2007	<i>Not applicable</i>
1.1	May 8, 2009	K.2. Changes prior to CTP 1.2.1
1.2	October 10, 2012	
1.2.1	August 5, 2020	
1.3	June 15, 2022	K.3. Changes between CTP 1.2.1 and CTP 1.3
1.3.1	August 26, 2022	K.4. Changes between CTP 1.3 and CTP 1.3.1
1.3.2	October 13, 2022	K.5. Changes between CTP 1.3.1 and CTP 1.3.2
1.3.3	February 8, 2023	K.6. Changes between CTP 1.3.2 and CTP 1.3.3
1.4b	July 18, 2023	K.7. Changes between CTP 1.3.3 and CTP 1.4b
This version		K.8. Changes between CTP 1.4b and this version

K.2. Changes prior to CTP 1.2.1

Changes to CTP releases prior to CTP 1.2.1 are described in the collection of documents titled *Revision To DCI Digital Cinema System Specification Compliance Test Plan* at <https://www.dci-movies.com/>.

K.3. Changes between CTP 1.2.1 and CTP 1.3

1. Add Support for OBAE

- Several procedures, and corresponding test materials, are added to cover OBAE requirements.
- Test sequences (Chapters 20 to 23) are added to cover OMB and IMBO Test Subjects.
- Appendix J is added to describe the expected acoustic outcome from rendering OBAE test materials.

2. Remove Incorrect Conditions on Remote SPB tests. The condition that the test *apply only to a Type 1 SPB device or module which implements features that allow it to supply keys or content to a remote SPB* was removed from the following procedures:

- 9.5.2. LE Key Generation
- 10.4.31. Idempotency of ITM RRP
- 10.4.32. RRP Synchronism

- 10.4.34. RRP Broadcast Prohibition
 - 10.4.36. RRP Initiator
 - 10.4.39. RRP "Busy" and Unsupported Types
 - 10.4.40. RRP Operational Messages
3. Clarify that Procedures 10.4.13. TLS Session Key Refreshes applies to sessions with Remote SPBs
 4. Clarify Requirements and Test Subjects for 10.4.13. TLS Session Key Refreshes
 5. Clarify TLS version requirements. See procedures:
 - 10.4.5. Secure SMS-SM Communication
 - 10.4.8. Secure Remote SPB-SM Communications
 - 10.4.39. RRP 'Busy' and Unsupported Types
 6. Update Procedure 10.4.72 to reflect DCSS 1.4 Erratum 6
 7. Clarify objective of Procedure 6.1.15 per DCSS 1.4 Erratum 16
 8. Require that OBAE essence is rendered within the SPB at Procedure 10.4.58
 9. Delete Procedure 3.5.3 as duplicate of Procedure 6.1.12
 10. Add Procedure 5.4.1.7. KDMDeleted Event to Chapter 15 test sequence
 11. Specify process for retrieving Log Reports at Procedure 5.3.2.1
 12. Add subtitle essence to Media Block tasks at Procedure 10.4.58
 13. Add support for RES and MIC certificate roles to Procedure 5.1.1
 14. Add Procedure 6.1.19 to verify that the Media Block supports published and reserved certificate
 15. Add support for KDM-borne MIC keys. See procedures:
 - 6.1.1. Image Integrity Checking
 - 6.1.2. Sound Integrity Checking
 - 6.1.17. OBAE Integrity Checking
 16. Change the test subject of Procedure 8.2.14. to the SMS
 17. Apply revision to CTP 1.2.1 dated 24 March 2021. Chapter 9 requirements are revised to include FIPS 140-3 compliance.
 18. Clarify the semantics of the CPLStart and CPLEnd Log Record tokens. See procedures:
 - 5.3.2.6. Log Report Signature Validity
 - 5.4.1.2. CPLStart Event
 - 5.4.1.3. CPLEnd Event

- o 6.1.8. Content Key Extension, End of Engagement
- o 6.1.12. Maximum Number of DCP Keys

19. Add missing Procedure 8.2.11 to test sequence Chapter 15

K.4. Changes between CTP 1.3 and CTP 1.3.1

1. Fix incorrect pass/fail classification of Procedure 8.2.2
2. Add missing procedures to Chapter 21 test sequence See procedures:
 - o 8.1.6. Storage System Performance
 - o 8.2.16. Interrupt Free Playback (OBAE)
 - o 8.2.17. Restarting Playback (OBAE)
 - o 8.2.18. Show Playlist Creation (OBAE)
3. Add reference to SMPTE ST 430-12:2014 AM1:2019
4. Replace references to OBAE Addendum with references to DCSS
5. Add reference to SMPTE ST 430-1:2017 AM1:2019

K.5. Changes between CTP 1.3.1 and CTP 1.3.2

1. Clarify Section 11.1 and add CTP version under test to Test Session Data (Table 11.1)
2. Clarify Chapter 20 requirements

K.6. Changes between CTP 1.3.2 and CTP 1.3.3

1. Deprecate selected Test Subjects. Support for the following Test Subjects and corresponding test sequences are removed:
 - o Digital Cinema Server (Chapter 13)
 - o Standalone D-Cinema Projector (Chapter 14)
 - o Link Decryptor/Encryptor (Chapter 16)
2. Clarify that each test sequence targets a single certificated device
3. Removed support for Remote SPBs
4. Allow SSD in addition to HDD for storage
5. Use encrypted test material for Procedure 7.3.2
6. Integrate "CTP Addendum on Testing" as Section 11.2
7. Allow either 19 or 20 bits of location data in the FM payload

8. Added test sequence (Chapter 24) for a Projector designed to work with an IMB or IMBO

K.7. Changes between CTP 1.3.3 and CTP 1.4b

1. Add SDR Direct View, HDR Direct View and HDR Projector test subjects. Corresponding test sequences (Chapters 26 to 28) are added.
2. Subject all Media Blocks to Procedure 6.7.1
3. Specify tolerances for SDR Projector procedures and make them pass/fail
4. Use a spectroradiometer instead of a photometer
5. Add stereoscopic image procedures
6. Use the term CMVP testing laboratory consistently
7. Rename track file and change duration of Test Material A.2.293
8. Rename track file and change duration of Test Material A.2.292
9. Fix incorrect "SPEAKING" OBAE expectations
10. Rename track file of Test Material A.2.251
11. Rename track file of Test Material A.2.254
12. Table 11.1: add Test Start Date
13. Clarify the position of the spectroradiometer at Procedures 7.1.1 and 7.5.15
14. Update test Procedures 7.5.12 and 7.5.26 to match revised RP 431-2
15. Clarify ambient light requirements for imaging device environments

K.8. Changes between CTP 1.4b and this version

1. Narrow the scope of Procedure 10.4.67 to Media Blocks
2. Remove Procedure 10.4.3 Security Devices Self-Test Capabilities
3. Remove Procedure 10.4.83 Encrypted Auxiliary Data Processing
4. Delete Procedure 10.4.55 Logging of Failed Procedures
5. Delete Procedure 10.4.17 Key Usage Time Window
6. Remove ASM and LE tests and references
7. Clarify the objective of Procedures 8.2.12 and 8.2.13
8. Specify pass/fail criteria for 10.4.1 Theater System Reliability
9. Remove ingest storage and network performance tests
10. Add summary of changes Appendix K

11. Fix test material filenames of Test Materials A.6.133 and A.6.134
12. Delete unreferenced Test Materials A.3.65 and A.3.67
13. Add valid KDM for DCI 2K Sync Test with KDM-Borne MIC Keys
14. Add missing KDM for Audio Tone Multi-Reel (Encrypted)
15. Fix Test Material numbering from A.6.135 to A.6.139
16. Update the definition of Direct View Display to match that in the DCSS
17. Remove unused test materials A.2.228, A.3.61 and A.3.69